

ALLEGATO B

**Specifiche tecniche per la fornitura
delle Dichiarazioni Precompilate**

Schema **fornituraP73_2016_v1.xsd**

schema location: [fornituraP73_2016_v1.xsd](#)
 attribute form default: **unqualified**
 element form default: **qualified**
 targetNamespace: **urn:www.agenziaentrate.gov.it:specificheTecniche:sco:p73**

Elements Complex types
Fornitura [Esito Richiesta Type](#)
 [Intestazione P73 Type](#)

schema location: [documentoP73_2016_v1.xsd](#)
 attribute form default: **unqualified**
 element form default: **qualified**
 targetNamespace: **urn:www.agenziaentrate.gov.it:specificheTecniche:sco:p73**

Complex types

[Acconti Altri Dati Type](#)
[Acconti Irpef Anno Imposta Type](#)

[Acconti Ritenute Type](#)
[Acquisto Costruzione Abit Locazione](#)
[Addizionali Type](#)
[Altre Detrazioni Type](#)
[Altre Ritenute Type](#)
[Altre Spese Type](#)
[Altri Dati Type](#)
[Altri Oneri Type](#)
[Altri Redditi Ass Lav Type](#)
[Altri Redditi Diversi Detr Type](#)
[Altri Redditi Diversi Type](#)
[Altri Redditi Lavoro Autonomo Type](#)
[Altri Redditi Type](#)
[Altri Redditi Utili Type](#)
[Assegno Coniuge Type](#)
[Bonus Irpef Type](#)
[Casella Acconto Type](#)
[Cedolare Secca Type](#)
[Conquaglio Type](#)
[Contributi Previdenza Complementare Type](#)
[Contributo Solidarieta Type](#)
[Cred Erogazione Cultura Type](#)
[Cred Imp Estero Type](#)
[Crediti F24 Type](#)
[Crediti Imposta Altri Sisma Abruzzo Type](#)
[Crediti Imposta Fabbicati Type](#)
[Crediti Imposta Fondi Pensione Type](#)
[Crediti Imposta Redditi Esteri Type](#)
[Crediti Imposta Type](#)
[Credito Erogazioni Cultura Type](#)
[Credito Immobile Sisma Abruzzo Type](#)
[Credito Negoziazione Type](#)
[Credito Stato Type](#)
[Credito Type](#)
[Dati 730 Integrativo Type](#)
[Dati Altre Detrazioni Modulo Type](#)
[Dati Altre Detrazioni Type](#)
[Dati Catastali Recupero Patrimonio Edilizio Type](#)
[Dati Catastali Type](#)

Simple types

[Anno Anticipazione Fondo Pensione Type](#)
[Anno Patrimonio Edilizio Situazioni Particolari Type](#)
[e](#)
[Anno Recupero Patrimonio Edilizio Type](#)
[Anno Risparmio Energetico Type](#)
[Casella Codice Type](#)
[Casi Particolari Fabbricato Type](#)
[Casi Particolari Risp Ener Type](#)
[Casi Particolari Terreni Type](#)
[Codice Altre Detrazioni Type](#)
[Codice Altre Spese Type](#)
[Codice Altri Oneri Type](#)
[Codice Canone Type](#)
[Codice Evento Eccezionale Type](#)
[Codice Spese Rateizzate Anni Precedenti Type](#)
[Codice Spese Rateizzate Type](#)
[Fabbricato Agev Numero Riqo Type](#)
[Indeterminato Determinato Type](#)
[Mesi Type](#)
[Numero Rata Risparmio Energetico Type](#)
[Numero Rate5o10 Type](#)
[Numero RateDa1A3 Type](#)
[Numero RateDa1A7 Type](#)
[Periodo Spese Ristrutturazione Type](#)
[Rate10 Type](#)
[Rate5 Type](#)
[Rate Risparmio Energetico Type](#)
[Reintegro Totale Parziale Type](#)
[Rideterminazione Rate Type](#)
[Ripart Risparmio Energetico Type](#)
[Serie Registrazione Contratto Type](#)
[Terreni Urbano Type](#)
[Tipo Inquilino Type](#)
[Tipo Intervento Type](#)
[Tipo Reddito Da1a12 Type](#)
[Tipo Reddito Da1a3 Type](#)
[Tipo Reddito Da1a4 Type](#)
[Tipo Reddito Da1a6 Type](#)
[Tipo Reddito Da1a8 Type](#)
[Tipo Reddito Da1a9 Type](#)
[Titolo Terreno Type](#)
[Utilizzo Fabbricato Type](#)

[Dati Coniuge Type](#)
[Dati Contabili Type](#)
[Dati Contratto Type](#)
[Dati Familiare Type](#)
[Dati Nascita PF Type](#)
[Dati Primo Figlio Type](#)
[Dati Registrazione Accatastamento Recupero Patrimonio Edilizio Type](#)
[Debito Type](#)
[Deduzioni Modulo Type](#)
[Deduzioni Type](#)
[Detrazione Crediti Type](#)
[Detrazioni Canoni Locazione Type](#)
[Detrazioni Modulo Type](#)
[Detrazioni Type](#)
[Documento P73 Type](#)
[Domanda Accatastamento Type](#)
[Domicilio Fiscale Type](#)
[Ecceденze Type](#)
[Elemento Integrativo Type](#)
[Esenzione Add Comunale Type](#)
[Esenzione Bonus Type](#)
[Esito Liquidazione Type](#)
[Fabbricato Agev Type](#)
[Fabbricato Ord Type](#)
[Familiari Type](#)
[Fondo Pensione Dipendenti Pubblici Type](#)
[Frontespizio 730 Type](#)
[Giorni Percentuale Type](#)
[Imposta Lorda Type](#)
[Imposta Netta Type](#)
[Imposte Rimborsate Type](#)
[Incremento Produttivita Type](#)
[Inquilini Abitazione Principale Type](#)
[Intervento Recupero Patrimonio Edilizio Type](#)
[Intervento Risparmio Energetico Type](#)
[Lavoro Dipendente Type](#)
[Misura Acconti Type](#)
[Modulo Altri Redditi Type](#)
[Modulo Crediti Imposta Type](#)
[Modulo Credito Negoziazione Type](#)
[Modulo Fabbricato Type](#)
[Modulo Familiari Type](#)
[Modulo Lavoro Dip Type](#)
[Modulo Oneri Type](#)
[Modulo PL Type](#)
[Modulo Terreno Type](#)

[N Rate Type](#)
[Oneri Non Abbattuti Type](#)
[Oneri Type](#)
[Opzione Produttivita Type](#)
[Periodo Di Lavoro Type](#)
[Primo Modulo Acconti Ritenute Type](#)
[Primo Modulo Crediti Imposta Type](#)
[Primo Modulo Familiari Type](#)
[Primo Modulo Lavoro Dip Type](#)
[Primo Modulo Oneri Type](#)
[Primo Modulo PL Type](#)
[Prospetto Liquidazione Type](#)
[Prospetto Type](#)
[Redditi Capitale Type](#)
[Redditi Eredi Legatari Type](#)
[Redditi Fabbricati Type](#)
[Redditi Lavoro Dip Type](#)
[Redditi Ritenute Spese Type](#)
[Redditi Ritenute Type](#)
[Redditi Tassazione Separata Type](#)
[Redditi Terreni Type](#)
[Reddito Erede Type](#)
[Residuo Credito Compens AnnoImposta Type](#)
[Residuo Credito Compens Type](#)
[Residuo Fabbricati Type](#)
[Restituzione Somme Type](#)
[Riepilogo Redditi Type](#)
[Ritenute Acconti Sospesi Type](#)
[Ritenute Lavoro Dip Type](#)
[Sezione Altri Redd Type](#)
[Sezione Dati Catastali Recupero Patrimonio Edilizio Type](#)
[Soggetto Fiscale 730 Type](#)
[Soglie Esenzione Type](#)
[Spese Arredo Type](#)
[Spese Rateizzate Anni Precedenti Type](#)
[Spese Rateizzate Type](#)
[Tassazione Separata Type](#)
[Terreno Type](#)

schema location: [sintetico730_2016.xsd](#)
attribute form default: **unqualified**
element form default: **qualified**
targetNamespace: **urn:www.agenziaentrate.gov.it:specificheTecniche:sco:p73**

Elements	Complex types	Simple types
ElencoFonti	AnagraficaType	DataType
Sintetico730	DatiAnagraficiType	DatoCFTType
	DettaglioFonteType	ImportoType
	DettaglioType	
	ElencoFontiType	
	FonteType	

schema location: [typesDati_v4.xsd](#)
attribute form default: **unqualified**
element form default: **qualified**
targetNamespace: **urn:www.agenziaentrate.gov.it:specificheTecniche:common**

Simple types
[DatoAN_Type](#)
[DatoCB12_Type](#)
[DatoCB_Type](#)
[DatoCF_Type](#)
[DatoCN_Type](#)
[DatoCP_Type](#)
[DatoD6_Type](#)
[DatoDA_Type](#)
[DatoDN_Type](#)
[DatoDT_Type](#)
[DatoEM_Type](#)
[DatoGA_Type](#)
[DatoN1_Type](#)
[DatoNP_Type](#)
[DatoNU_Type](#)
[DatoPC_Type](#)
[DatoPI_Type](#)
[DatoQU_Type](#)
[DatoTL_Type](#)
[DatoVP_Type](#)

schema location: [fornitura_v4.xsd](#)
attribute form default: **unqualified**
element form default: **qualified**
targetNamespace: **urn:www.agenziaentrate.gov.it:specificheTecniche:common**

Elements Complex types Simple types
[Documento](#) [Documento Type](#) [Identificativo Type](#)

schema location: [datiFiscali_v5.xsd](#)
attribute form default: **unqualified**
element form default: **qualified**
targetNamespace: **urn:www.agenziaentrate.gov.it:specificheTecniche:sco:common**

Complex types

[Dati_Anagrafici Type](#)
[Dati_Sottoscrittore Type](#)
[Domicilio_EE Type](#)
[Domicilio_Fiscale Type](#)
[Domicilio_Ita Type](#)
[Firma_Revisore Type](#)
[Firma Type](#)
[Frontespizio Type](#)
[Impegno_A Trasmettere Type](#)
[Persone Fisiche Type](#)
[Residenza_Anagrafica Type](#)
[Residenza_Estera Type](#)
[Soggetti_Diversi_Da PF Type](#)
[Soggetti_Non Residenti Type](#)
[Soggetto_Fiscale Type](#)
[Tipo Dichiarazione Type](#)
[Visto_Conformita Type](#)

schema location: [typesProvincie_v4.xsd](#)
attribute form default: **unqualified**
element form default: **qualified**
targetNamespace: **urn:www.agenziaentrate.gov.it:specificheTecniche:common**

Simple types

[Estero](#)
[PE Type](#)
[PN Type](#)
[PR Type](#)
[ProvincieCroate](#)
[ProvincieItaliane](#)
[ProvincieSoppresse](#)

schema location: [typesFiscali_v5.xsd](#)
 attribute form default: unqualified
 element form default: qualified
 targetNamespace: urn:www.agenziaentrate.gov.it:specificheTecniche:sco:common

Simple types

- [Casella Quadro Type](#)
- [Codice Carica Type](#)
- [Codice Regione Type](#)
- [Natura Giuridica Type](#)
- [Sesso Type](#)
- [Situazione Type](#)
- [Stato Type](#)

schema location: [typeEventi_v4.xsd](#)
 attribute form default: unqualified
 element form default: qualified
 targetNamespace: urn:www.agenziaentrate.gov.it:specificheTecniche:sco:common

Simple types

- [Eventi Ecc Type](#)

element Fornitura

diagram	
namespace	urn:www.agenziaentrate.gov.it:specificheTecniche:sco:p73
children	p73:Intestazione p73:EsitoRichiesta

element Fornitura/Intestazione

diagram	
---------	--

namespace	urn:www.agenziaentrate.gov.it:specificheTecniche:sco:p73
type	p73:Intestazione_P73_Type
children	p73:CodiceFornitura p73:TotaleDocRichiesti p73:TotaleDocForniti p73:TotaleDocScartati p73:TotaleDocNonReperiti

element **Fornitura/EsitoRichiesta**

diagram	
namespace	urn:www.agenziaentrate.gov.it:specificheTecniche:sco:p73
type	p73:Esito_Richiesta_Type
children	p73:CodiceFiscaleRichiesta p73:AnagraficaContribuente p73:DocumentoP73 p73:Sintetico730 p73:Stato

complexType **Esito_Richiesta_Type**

diagram	
namespace	urn:www.agenziaentrate.gov.it:specificheTecniche:sco:p73
children	p73:CodiceFiscaleRichiesta p73:AnagraficaContribuente p73:DocumentoP73 p73:Sintetico730 p73:Stato

element **Esito_Richiesta_Type/CodiceFiscaleRichiesta**

diagram	
namespace	urn:www.agenziaentrate.gov.it:specificheTecniche:sco:p73

element Esito_Richiesta_Type/AnagraficaContribuente

diagram	
namespace	urn:www.agenziaentrate.gov.it:specificheTecniche:sco:p73
children	p73:CodiceFiscale p73:Cognome p73:Nome

element Esito_Richiesta_Type/AnagraficaContribuente/CodiceFiscale

diagram					
namespace	urn:www.agenziaentrate.gov.it:specificheTecniche:sco:p73				
type	DatoCF_Type				
facets	<table border="0"> <tr> <td>Kind</td> <td>Value</td> </tr> <tr> <td>pattern</td> <td>[0-9]{11}[A-Z]{6}[0-9LMNPQRSTUUV]{2}[A-Z]{1}[0-9LMNPQRSTUUV]{2}[A-Z]{1}[0-9LMNPQRSTUUV]{3}[A-Z]{1}</td> </tr> </table>	Kind	Value	pattern	[0-9]{11}[A-Z]{6}[0-9LMNPQRSTUUV]{2}[A-Z]{1}[0-9LMNPQRSTUUV]{2}[A-Z]{1}[0-9LMNPQRSTUUV]{3}[A-Z]{1}
Kind	Value				
pattern	[0-9]{11}[A-Z]{6}[0-9LMNPQRSTUUV]{2}[A-Z]{1}[0-9LMNPQRSTUUV]{2}[A-Z]{1}[0-9LMNPQRSTUUV]{3}[A-Z]{1}				

element Esito_Richiesta_Type/AnagraficaContribuente/Cognome

diagram					
namespace	urn:www.agenziaentrate.gov.it:specificheTecniche:sco:p73				
type	DatoAN_Type				
facets	<table border="0"> <tr> <td>Kind</td> <td>Value</td> </tr> <tr> <td>pattern</td> <td>(([0-9A-Z-] \&quot;){1}([0-9A-Z&amp;:] ' \" _ . / ^\\(\\) À É È Ì Ò Ù Û &quot; \\ \\ \\+)*</td> </tr> </table>	Kind	Value	pattern	(([0-9A-Z-] \"){1}([0-9A-Z&:] ' \" _ . / ^\\(\\) À É È Ì Ò Ù Û " \\ \\ \\+)*
Kind	Value				
pattern	(([0-9A-Z-] \"){1}([0-9A-Z&:] ' \" _ . / ^\\(\\) À É È Ì Ò Ù Û " \\ \\ \\+)*				

element Esito_Richiesta_Type/AnagraficaContribuente/Nome

diagram					
namespace	urn:www.agenziaentrate.gov.it:specificheTecniche:sco:p73				
type	DatoAN_Type				
facets	<table border="0"> <tr> <td>Kind</td> <td>Value</td> </tr> <tr> <td>pattern</td> <td>(([0-9A-Z-] \&quot;){1}([0-9A-Z&amp;:] ' \" _ . / ^\\(\\) À É È Ì Ò Ù Û &quot; \\ \\ \\+)*</td> </tr> </table>	Kind	Value	pattern	(([0-9A-Z-] \"){1}([0-9A-Z&:] ' \" _ . / ^\\(\\) À É È Ì Ò Ù Û " \\ \\ \\+)*
Kind	Value				
pattern	(([0-9A-Z-] \"){1}([0-9A-Z&:] ' \" _ . / ^\\(\\) À É È Ì Ò Ù Û " \\ \\ \\+)*				

element **Esito_Richiesta_Type/DocumentoP73**

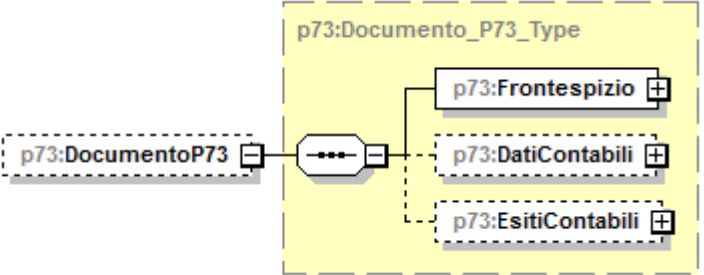
diagram	
namespace	urn:www.agenziaentrate.gov.it:specificheTecniche:sco:p73
type	p73:Documento_P73_Type
children	p73:Frontespizio p73:DatiContabili p73:EsitiContabili

element **Esito_Richiesta_Type/Stato**

diagram					
namespace	urn:www.agenziaentrate.gov.it:specificheTecniche:sco:p73				
type	DatoAN_Type				
facets	<table border="1"> <thead> <tr> <th>Kind</th> <th>Value</th> </tr> </thead> <tbody> <tr> <td>pattern</td> <td>(([0-9A-Z-])&quot;){1}([0-9A-Z&amp;:] ' "- \., / "^\(\ \)\ À É Ê Ì Ò Ù Û &quot; \ \\ / +)*</td> </tr> </tbody> </table>	Kind	Value	pattern	(([0-9A-Z-])"){1}([0-9A-Z&:] ' "- \., / "^\(\ \)\ À É Ê Ì Ò Ù Û " \ \\ / +)*
Kind	Value				
pattern	(([0-9A-Z-])"){1}([0-9A-Z&:] ' "- \., / "^\(\ \)\ À É Ê Ì Ò Ù Û " \ \\ / +)*				

complexType **Intestazione_P73_Type**

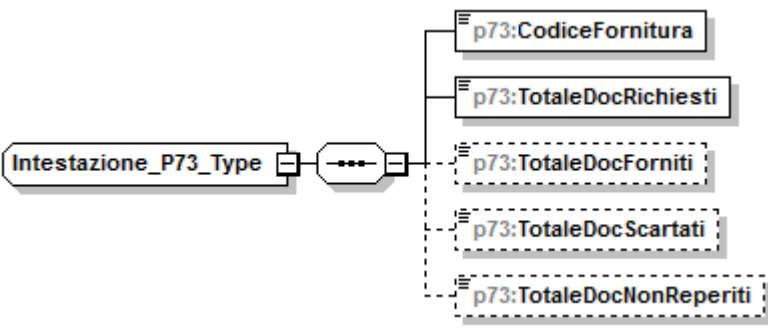
diagram	
namespace	urn:www.agenziaentrate.gov.it:specificheTecniche:sco:p73
children	p73:CodiceFornitura p73:TotaleDocRichiesti p73:TotaleDocForniti p73:TotaleDocScartati p73:TotaleDocNonReperiti

element **Intestazione_P73_Type/CodiceFornitura**

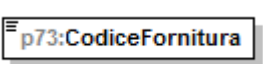
diagram	
namespace	urn:www.agenziaentrate.gov.it:specificheTecniche:sco:p73
type	restriction of DatoAN_Type

facets	Kind Value pattern ([0-9A-Z\-_]"){1}([0-9A-Z&:] \" \- \., / ^ \^\(\\ \\) À É Ê Ë Ì Ó Ù Ú Û " \\ \\ \\ +)*
--------	--

element Intestazione_P73_Type/TotaleDocRichiesti

diagram	
namespace	urn:www.agenziaentrate.gov.it:specificheTecniche:sco:p73
type	DatoNP_Type
facets	Kind Value pattern [1-9]{1}[0-9]*

element Intestazione_P73_Type/TotaleDocForniti

diagram	
namespace	urn:www.agenziaentrate.gov.it:specificheTecniche:sco:p73
type	DatoNP_Type
facets	Kind Value pattern [1-9]{1}[0-9]*

element Intestazione_P73_Type/TotaleDocScartati

diagram	
namespace	urn:www.agenziaentrate.gov.it:specificheTecniche:sco:p73
type	DatoNP_Type
facets	Kind Value pattern [1-9]{1}[0-9]*

element Intestazione_P73_Type/TotaleDocNonReperiti

diagram	
namespace	urn:www.agenziaentrate.gov.it:specificheTecniche:sco:p73
type	DatoNP_Type
facets	Kind Value pattern [1-9]{1}[0-9]*

complexType **Acconti_Altri_Dati_Type**

diagram	
namespace	urn:www.agenziaentrate.gov.it:specificheTecniche:sco:p73
children	p73:IncapientiDetrazioneFigli p73:IncapientiDetrazioneLocazione p73:RestituzioneBonusFiscale p73:RestituzioneBonusStraordinario p73:Pignoramento

element **Acconti_Altri_Dati_Type/IncapientiDetrazioneFigli**

diagram					
namespace	urn:www.agenziaentrate.gov.it:specificheTecniche:sco:p73				
type	DatoNP_Type				
facets	<table border="1"> <thead> <tr> <th>Kind</th> <th>Value</th> </tr> </thead> <tbody> <tr> <td>pattern</td> <td>[1-9]{1}[0-9]*</td> </tr> </tbody> </table>	Kind	Value	pattern	[1-9]{1}[0-9]*
Kind	Value				
pattern	[1-9]{1}[0-9]*				

element **Acconti_Altri_Dati_Type/IncapientiDetrazioneLocazione**

diagram					
namespace	urn:www.agenziaentrate.gov.it:specificheTecniche:sco:p73				
type	DatoNP_Type				
facets	<table border="1"> <thead> <tr> <th>Kind</th> <th>Value</th> </tr> </thead> <tbody> <tr> <td>pattern</td> <td>[1-9]{1}[0-9]*</td> </tr> </tbody> </table>	Kind	Value	pattern	[1-9]{1}[0-9]*
Kind	Value				
pattern	[1-9]{1}[0-9]*				

element **Acconti_Altri_Dati_Type/RestituzioneBonusFiscale**

diagram					
namespace	urn:www.agenziaentrate.gov.it:specificheTecniche:sco:p73				
type	DatoNP_Type				
facets	<table border="1"> <thead> <tr> <th>Kind</th> <th>Value</th> </tr> </thead> <tbody> <tr> <td>pattern</td> <td>[1-9]{1}[0-9]*</td> </tr> </tbody> </table>	Kind	Value	pattern	[1-9]{1}[0-9]*
Kind	Value				
pattern	[1-9]{1}[0-9]*				

element Acconti_Altri_Dati_Type/RestituzioneBonusStraordinario

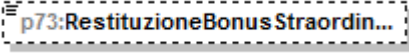
diagram					
namespace	urn:www.agenziaentrate.gov.it:specificheTecniche:sco:p73				
type	DatoNP_Type				
facets	<table border="0"> <tr> <td>Kind</td> <td>Value</td> </tr> <tr> <td>pattern</td> <td>[1-9]{1}[0-9]*</td> </tr> </table>	Kind	Value	pattern	[1-9]{1}[0-9]*
Kind	Value				
pattern	[1-9]{1}[0-9]*				

element Acconti_Altri_Dati_Type/Pignoramento

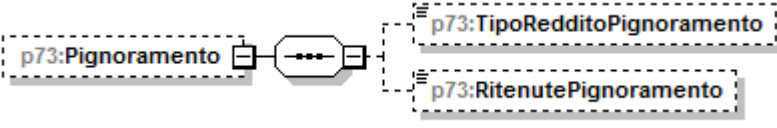
diagram	
namespace	urn:www.agenziaentrate.gov.it:specificheTecniche:sco:p73
children	p73:TipoRedditoPignoramento p73:RitenutePignoramento

element Acconti_Altri_Dati_Type/Pignoramento/TipoRedditoPignoramento

diagram																	
namespace	urn:www.agenziaentrate.gov.it:specificheTecniche:sco:p73																
type	restriction of DatoN1_Type																
facets	<table border="0"> <tr> <td>Kind</td> <td>Value</td> </tr> <tr> <td>pattern</td> <td>[1-9]</td> </tr> <tr> <td>enumeration</td> <td>1</td> </tr> <tr> <td>enumeration</td> <td>2</td> </tr> <tr> <td>enumeration</td> <td>3</td> </tr> <tr> <td>enumeration</td> <td>4</td> </tr> <tr> <td>enumeration</td> <td>5</td> </tr> <tr> <td>enumeration</td> <td>6</td> </tr> </table>	Kind	Value	pattern	[1-9]	enumeration	1	enumeration	2	enumeration	3	enumeration	4	enumeration	5	enumeration	6
Kind	Value																
pattern	[1-9]																
enumeration	1																
enumeration	2																
enumeration	3																
enumeration	4																
enumeration	5																
enumeration	6																

element Acconti_Altri_Dati_Type/Pignoramento/RitenutePignoramento

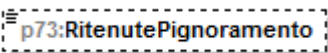
diagram					
namespace	urn:www.agenziaentrate.gov.it:specificheTecniche:sco:p73				
type	DatoNP_Type				
facets	<table border="0"> <tr> <td>Kind</td> <td>Value</td> </tr> <tr> <td>pattern</td> <td>[1-9]{1}[0-9]*</td> </tr> </table>	Kind	Value	pattern	[1-9]{1}[0-9]*
Kind	Value				
pattern	[1-9]{1}[0-9]*				

complexType **Acconti_Irpef_Anno_Imposta_Type**

diagram	
namespace	urn:www.agenziaentrate.gov.it:specificheTecniche:sco:p73
children	p73:PrimaRataAccontolrpef p73:SecondaRataAccontolrpef p73:AccontoAddComunale p73:AccontoAddComunaleF24 p73:PrimaRataAccontoCedolare p73:SecondaRataAccontoCedolare

element **Acconti_Irpef_Anno_Imposta_Type/PrimaRataAccontolrpef**

diagram					
namespace	urn:www.agenziaentrate.gov.it:specificheTecniche:sco:p73				
type	DatoNP_Type				
facets	<table border="1"> <tr> <td>Kind</td> <td>Value</td> </tr> <tr> <td>pattern</td> <td>[1-9]{1}[0-9]*</td> </tr> </table>	Kind	Value	pattern	[1-9]{1}[0-9]*
Kind	Value				
pattern	[1-9]{1}[0-9]*				

element **Acconti_Irpef_Anno_Imposta_Type/SecondaRataAccontolrpef**

diagram					
namespace	urn:www.agenziaentrate.gov.it:specificheTecniche:sco:p73				
type	DatoNP_Type				
facets	<table border="1"> <tr> <td>Kind</td> <td>Value</td> </tr> <tr> <td>pattern</td> <td>[1-9]{1}[0-9]*</td> </tr> </table>	Kind	Value	pattern	[1-9]{1}[0-9]*
Kind	Value				
pattern	[1-9]{1}[0-9]*				

element **Acconti_Irpef_Anno_Imposta_Type/AccontoAddComunale**

diagram					
namespace	urn:www.agenziaentrate.gov.it:specificheTecniche:sco:p73				
type	DatoNP_Type				
facets	<table border="1"> <tr> <td>Kind</td> <td>Value</td> </tr> <tr> <td>pattern</td> <td>[1-9]{1}[0-9]*</td> </tr> </table>	Kind	Value	pattern	[1-9]{1}[0-9]*
Kind	Value				
pattern	[1-9]{1}[0-9]*				

element **Acconti_Irpef_Anno_Imposta_Type/AccontoAddComunaleF24**

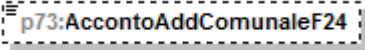
diagram					
namespace	urn:www.agenziaentrate.gov.it:specificheTecniche:sco:p73				
type	DatoNP_Type				
facets	<table border="1"> <tr> <td>Kind</td> <td>Value</td> </tr> <tr> <td>pattern</td> <td>[1-9]{1}[0-9]*</td> </tr> </table>	Kind	Value	pattern	[1-9]{1}[0-9]*
Kind	Value				
pattern	[1-9]{1}[0-9]*				

element **Acconti_Irpef_Anno_Imposta_Type/PrimaRataAccontoCedolare**

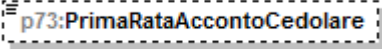
diagram					
namespace	urn:www.agenziaentrate.gov.it:specificheTecniche:sco:p73				
type	DatoNP_Type				
facets	<table border="1"> <tr> <td>Kind</td> <td>Value</td> </tr> <tr> <td>pattern</td> <td>[1-9]{1}[0-9]*</td> </tr> </table>	Kind	Value	pattern	[1-9]{1}[0-9]*
Kind	Value				
pattern	[1-9]{1}[0-9]*				

element **Acconti_Irpef_Anno_Imposta_Type/SecondaRataAccontoCedolare**

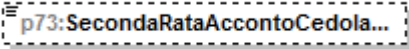
diagram					
namespace	urn:www.agenziaentrate.gov.it:specificheTecniche:sco:p73				
type	DatoNP_Type				
facets	<table border="1"> <tr> <td>Kind</td> <td>Value</td> </tr> <tr> <td>pattern</td> <td>[1-9]{1}[0-9]*</td> </tr> </table>	Kind	Value	pattern	[1-9]{1}[0-9]*
Kind	Value				
pattern	[1-9]{1}[0-9]*				

complexType **Acconti_Ritenute_Type**

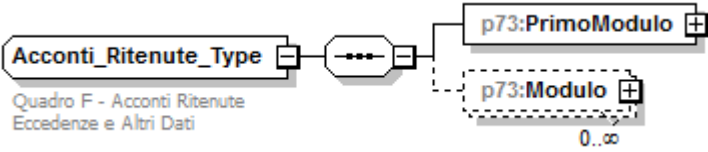
diagram	
namespace	urn:www.agenziaentrate.gov.it:specificheTecniche:sco:p73
children	p73:PrimoModulo p73:Modulo

element **Acconti_Ritenute_Type/PrimoModulo**

<p>diagram</p>	
<p>namespace</p>	<p>urn:www.agenziaentrate.gov.it:specificheTecniche:sco:p73</p>
<p>type</p>	<p>p73:Primo Modulo Acconti Ritenute Type</p>
<p>children</p>	<p>p73:Accontilrpef p73:AltreRitenute p73:Eccedenze p73:RitenuteAccontiSospesi p73:MisuraAcconti p73:EsenzioneAddComunale p73:Dati730Integrativo p73:AccontiAltriDati</p>

element **Acconti_Ritenute_Type/Modulo**

<p>diagram</p>	
<p>namespace</p>	<p>urn:www.agenziaentrate.gov.it:specificheTecniche:sco:p73</p>
<p>children</p>	<p>p73:Pignoramento</p>

element **Acconti_Ritenute_Type/Modulo/Pignoramento**

<p>diagram</p>	
<p>namespace</p>	<p>urn:www.agenziaentrate.gov.it:specificheTecniche:sco:p73</p>
<p>children</p>	<p>p73:TipoRedditoPignoramento p73:RitenutePignoramento</p>

element **Acconti_Ritenute_Type/Modulo/Pignoramento/TipoRedditoPignoramento**

diagram																	
namespace	urn:www.agenziaentrate.gov.it:specificheTecniche:sco:p73																
type	restriction of DatoN1_Type																
facets	<table border="1"> <thead> <tr> <th>Kind</th> <th>Value</th> </tr> </thead> <tbody> <tr> <td>pattern</td> <td>[1-9]</td> </tr> <tr> <td>enumeration</td> <td>1</td> </tr> <tr> <td>enumeration</td> <td>2</td> </tr> <tr> <td>enumeration</td> <td>3</td> </tr> <tr> <td>enumeration</td> <td>4</td> </tr> <tr> <td>enumeration</td> <td>5</td> </tr> <tr> <td>enumeration</td> <td>6</td> </tr> </tbody> </table>	Kind	Value	pattern	[1-9]	enumeration	1	enumeration	2	enumeration	3	enumeration	4	enumeration	5	enumeration	6
Kind	Value																
pattern	[1-9]																
enumeration	1																
enumeration	2																
enumeration	3																
enumeration	4																
enumeration	5																
enumeration	6																

element **Acconti_Ritenute_Type/Modulo/Pignoramento/RitenutePignoramento**

diagram					
namespace	urn:www.agenziaentrate.gov.it:specificheTecniche:sco:p73				
type	DatoNP_Type				
facets	<table border="1"> <thead> <tr> <th>Kind</th> <th>Value</th> </tr> </thead> <tbody> <tr> <td>pattern</td> <td>[1-9]{1}[0-9]*</td> </tr> </tbody> </table>	Kind	Value	pattern	[1-9]{1}[0-9]*
Kind	Value				
pattern	[1-9]{1}[0-9]*				

complexType **Acquisto_Costruzione_Abit_Locazione**

diagram	
namespace	urn:www.agenziaentrate.gov.it:specificheTecniche:sco:p73
children	p73:DataStipula p73:Spesa p73:InteressiMutuo

element **Acquisto_Costruzione_Abit_Locazione/DataStipula**

diagram					
namespace	urn:www.agenziaentrate.gov.it:specificheTecniche:sco:p73				
type	DatoDT_Type				
facets	<table border="1"> <thead> <tr> <th>Kind</th> <th>Value</th> </tr> </thead> <tbody> <tr> <td>pattern</td> <td>((([0-9]{1,12}[0-9]{3,10})([0-9]{1,12}(\d{4}))) ([0-9]{1,12}[0-9]{3,10}(0[469][11](\d{4}))) ([0-9]{1,12}[0-9]{2,8})(02(\d{4}))) ((29)(02)([02468][048]00)) ((29)(02)([13579][26]00)) ((29)(02)([0-9][0-9][0][48])) ((29)(02)([0-9][0-9][2468][048])) ((29)(02)([0-9][0-9][13579][26]))))</td> </tr> </tbody> </table>	Kind	Value	pattern	((([0-9]{1,12}[0-9]{3,10})([0-9]{1,12}(\d{4}))) ([0-9]{1,12}[0-9]{3,10}(0[469][11](\d{4}))) ([0-9]{1,12}[0-9]{2,8})(02(\d{4}))) ((29)(02)([02468][048]00)) ((29)(02)([13579][26]00)) ((29)(02)([0-9][0-9][0][48])) ((29)(02)([0-9][0-9][2468][048])) ((29)(02)([0-9][0-9][13579][26]))))
Kind	Value				
pattern	((([0-9]{1,12}[0-9]{3,10})([0-9]{1,12}(\d{4}))) ([0-9]{1,12}[0-9]{3,10}(0[469][11](\d{4}))) ([0-9]{1,12}[0-9]{2,8})(02(\d{4}))) ((29)(02)([02468][048]00)) ((29)(02)([13579][26]00)) ((29)(02)([0-9][0-9][0][48])) ((29)(02)([0-9][0-9][2468][048])) ((29)(02)([0-9][0-9][13579][26]))))				

element **Acquisto_Costruzione_Abit_Locazione/Spesa**

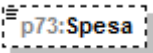
diagram	
namespace	urn:www.agenziaentrate.gov.it:specificheTecniche:sco:p73
type	DatoNP_Type
facets	Kind Value pattern [1-9]{1}[0-9]*

element **Acquisto_Costruzione_Abit_Locazione/InteressiMutuo**

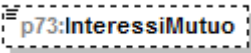
diagram	
namespace	urn:www.agenziaentrate.gov.it:specificheTecniche:sco:p73
type	DatoNP_Type
facets	Kind Value pattern [1-9]{1}[0-9]*

complexType **Addizionali_Type**

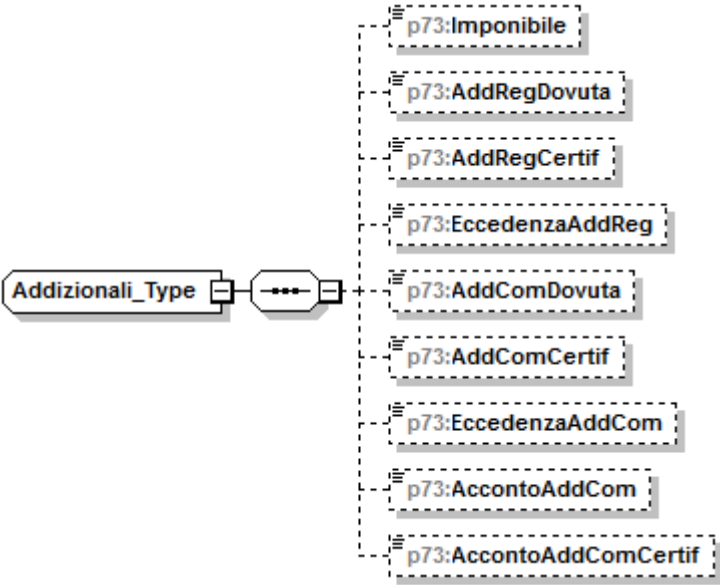
diagram	
namespace	urn:www.agenziaentrate.gov.it:specificheTecniche:sco:p73
children	p73:Imponibile p73:AddRegDovuta p73:AddRegCertif p73:EccedenzaAddReg p73:AddComDovuta p73:AddComCertif p73:EccedenzaAddCom p73:AccontoAddCom p73:AccontoAddComCertif

element **Addizionali_Type/Imponibile**

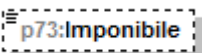
diagram	
namespace	urn:www.agenziaentrate.gov.it:specificheTecniche:sco:p73

type	DatoNP_Type
facets	Kind Value pattern [1-9]{1}[0-9]*

element `Additional_Type/AddRegDovuta`

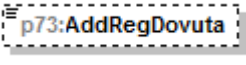
diagram	
namespace	urn:www.agenziaentrate.gov.it:specificheTecniche:sco:p73
type	DatoNP_Type
facets	Kind Value pattern [1-9]{1}[0-9]*

element `Additional_Type/AddRegCertif`

diagram	
namespace	urn:www.agenziaentrate.gov.it:specificheTecniche:sco:p73
type	DatoNP_Type
facets	Kind Value pattern [1-9]{1}[0-9]*

element `Additional_Type/EccedenzaAddReg`

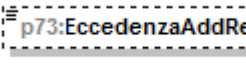
diagram	
namespace	urn:www.agenziaentrate.gov.it:specificheTecniche:sco:p73
type	DatoNU_Type
facets	Kind Value pattern (\-[1-9] [1-9])[0-9]*

element `Additional_Type/AddComDovuta`

diagram	
namespace	urn:www.agenziaentrate.gov.it:specificheTecniche:sco:p73
type	DatoNP_Type
facets	Kind Value pattern [1-9]{1}[0-9]*

element `Additional_Type/AddComCertif`

diagram	
namespace	urn:www.agenziaentrate.gov.it:specificheTecniche:sco:p73

type	DatoNP_Type
facets	Kind Value pattern [1-9]{1}[0-9]*

element Additionali_Type/EccedenzaAddCom

diagram	
namespace	urn:www.agenziaentrate.gov.it:specificheTecniche:sco:p73
type	DatoNU_Type
facets	Kind Value pattern (\-[1-9] [1-9])[0-9]*

element Additionali_Type/AccontoAddCom

diagram	
namespace	urn:www.agenziaentrate.gov.it:specificheTecniche:sco:p73
type	DatoNP_Type
facets	Kind Value pattern [1-9]{1}[0-9]*

element Additionali_Type/AccontoAddComCertif

diagram	
namespace	urn:www.agenziaentrate.gov.it:specificheTecniche:sco:p73
type	DatoNP_Type
facets	Kind Value pattern [1-9]{1}[0-9]*

complexType Altre_Detrazioni_Type

diagram	
namespace	urn:www.agenziaentrate.gov.it:specificheTecniche:sco:p73
children	p73:Codice p73:Importo

element Altre_Detrazioni_Type/Codice

diagram	
---------	--

namespace	urn:www.agenziaentrate.gov.it:specificheTecniche:sco:p73								
type	p73:Codice_Altre_Detrazioni_Type								
facets	<table border="0"> <tr> <td>Kind</td> <td>Value</td> </tr> <tr> <td>pattern</td> <td>[1-9]{1}[0-9]*</td> </tr> <tr> <td>enumeration</td> <td>1</td> </tr> <tr> <td>enumeration</td> <td>2</td> </tr> </table>	Kind	Value	pattern	[1-9]{1}[0-9]*	enumeration	1	enumeration	2
Kind	Value								
pattern	[1-9]{1}[0-9]*								
enumeration	1								
enumeration	2								

element Altre_Detrazioni_Type/Importo

diagram					
namespace	urn:www.agenziaentrate.gov.it:specificheTecniche:sco:p73				
type	DatoNP_Type				
facets	<table border="0"> <tr> <td>Kind</td> <td>Value</td> </tr> <tr> <td>pattern</td> <td>[1-9]{1}[0-9]*</td> </tr> </table>	Kind	Value	pattern	[1-9]{1}[0-9]*
Kind	Value				
pattern	[1-9]{1}[0-9]*				

complexType Altre_Ritenute_Type

diagram	
namespace	urn:www.agenziaentrate.gov.it:specificheTecniche:sco:p73
children	p73:AltreRitenuteIrpef p73:AddizionaleRegionale p73:AddizionaleComunale p73:AddRegionaleIrpefAttivitaSport p73:AddComunaleIrpefAttivitaSport p73:IrpefLavoriSocialmenteUtili p73:AddRegionaleIrpefLavoriSo... Utili

element Altre_Ritenute_Type/AltreRitenuteIrpef

diagram					
namespace	urn:www.agenziaentrate.gov.it:specificheTecniche:sco:p73				
type	DatoNP_Type				
facets	<table border="0"> <tr> <td>Kind</td> <td>Value</td> </tr> <tr> <td>pattern</td> <td>[1-9]{1}[0-9]*</td> </tr> </table>	Kind	Value	pattern	[1-9]{1}[0-9]*
Kind	Value				
pattern	[1-9]{1}[0-9]*				

element **Altre_Ritenute_Type/AddizionaleRegionale**

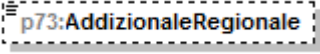
diagram	
namespace	urn:www.agenziaentrate.gov.it:specificheTecniche:sco:p73
type	DatoNP_Type
facets	Kind Value pattern [1-9]{1}[0-9]*

element **Altre_Ritenute_Type/AddizionaleComunale**

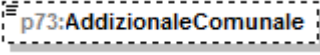
diagram	
namespace	urn:www.agenziaentrate.gov.it:specificheTecniche:sco:p73
type	DatoNP_Type
facets	Kind Value pattern [1-9]{1}[0-9]*

element **Altre_Ritenute_Type/AddRegionaleIrpefAttivitaSport**

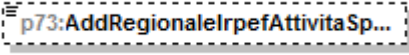
diagram	
namespace	urn:www.agenziaentrate.gov.it:specificheTecniche:sco:p73
type	DatoNP_Type
facets	Kind Value pattern [1-9]{1}[0-9]*

element **Altre_Ritenute_Type/AddComunaleIrpefAttivitaSport**

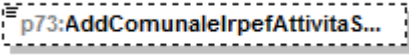
diagram	
namespace	urn:www.agenziaentrate.gov.it:specificheTecniche:sco:p73
type	DatoNP_Type
facets	Kind Value pattern [1-9]{1}[0-9]*

element **Altre_Ritenute_Type/IrpefLavoriSocialmenteUtili**

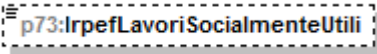
diagram	
namespace	urn:www.agenziaentrate.gov.it:specificheTecniche:sco:p73
type	DatoNP_Type
facets	Kind Value pattern [1-9]{1}[0-9]*

element **Altre_Ritenute_Type/AddRegionaleIrpefLavoriSoc_Utili**

diagram					
namespace	urn:www.agenziaentrate.gov.it:specificheTecniche:sco:p73				
type	DatoNP_Type				
facets	<table border="1"> <thead> <tr> <th>Kind</th> <th>Value</th> </tr> </thead> <tbody> <tr> <td>pattern</td> <td>[1-9]{1}[0-9]*</td> </tr> </tbody> </table>	Kind	Value	pattern	[1-9]{1}[0-9]*
Kind	Value				
pattern	[1-9]{1}[0-9]*				

complexType **Altre_Spese_Type**

diagram	
namespace	urn:www.agenziaentrate.gov.it:specificheTecniche:sco:p73
children	p73:Codice p73:Importo

element **Altre_Spese_Type/Codice**

diagram																																																																	
namespace	urn:www.agenziaentrate.gov.it:specificheTecniche:sco:p73																																																																
type	p73:Codice Altre_Spese_Type																																																																
facets	<table border="1"> <thead> <tr> <th>Kind</th> <th>Value</th> </tr> </thead> <tbody> <tr> <td>pattern</td> <td>[1-9]{1}[0-9]*</td> </tr> <tr><td>enumeration</td><td>8</td></tr> <tr><td>enumeration</td><td>9</td></tr> <tr><td>enumeration</td><td>10</td></tr> <tr><td>enumeration</td><td>11</td></tr> <tr><td>enumeration</td><td>12</td></tr> <tr><td>enumeration</td><td>13</td></tr> <tr><td>enumeration</td><td>14</td></tr> <tr><td>enumeration</td><td>15</td></tr> <tr><td>enumeration</td><td>16</td></tr> <tr><td>enumeration</td><td>17</td></tr> <tr><td>enumeration</td><td>18</td></tr> <tr><td>enumeration</td><td>20</td></tr> <tr><td>enumeration</td><td>21</td></tr> <tr><td>enumeration</td><td>22</td></tr> <tr><td>enumeration</td><td>23</td></tr> <tr><td>enumeration</td><td>24</td></tr> <tr><td>enumeration</td><td>25</td></tr> <tr><td>enumeration</td><td>26</td></tr> <tr><td>enumeration</td><td>27</td></tr> <tr><td>enumeration</td><td>28</td></tr> <tr><td>enumeration</td><td>29</td></tr> <tr><td>enumeration</td><td>30</td></tr> <tr><td>enumeration</td><td>31</td></tr> <tr><td>enumeration</td><td>32</td></tr> <tr><td>enumeration</td><td>33</td></tr> <tr><td>enumeration</td><td>35</td></tr> <tr><td>enumeration</td><td>36</td></tr> <tr><td>enumeration</td><td>37</td></tr> <tr><td>enumeration</td><td>41</td></tr> <tr><td>enumeration</td><td>42</td></tr> </tbody> </table>	Kind	Value	pattern	[1-9]{1}[0-9]*	enumeration	8	enumeration	9	enumeration	10	enumeration	11	enumeration	12	enumeration	13	enumeration	14	enumeration	15	enumeration	16	enumeration	17	enumeration	18	enumeration	20	enumeration	21	enumeration	22	enumeration	23	enumeration	24	enumeration	25	enumeration	26	enumeration	27	enumeration	28	enumeration	29	enumeration	30	enumeration	31	enumeration	32	enumeration	33	enumeration	35	enumeration	36	enumeration	37	enumeration	41	enumeration	42
Kind	Value																																																																
pattern	[1-9]{1}[0-9]*																																																																
enumeration	8																																																																
enumeration	9																																																																
enumeration	10																																																																
enumeration	11																																																																
enumeration	12																																																																
enumeration	13																																																																
enumeration	14																																																																
enumeration	15																																																																
enumeration	16																																																																
enumeration	17																																																																
enumeration	18																																																																
enumeration	20																																																																
enumeration	21																																																																
enumeration	22																																																																
enumeration	23																																																																
enumeration	24																																																																
enumeration	25																																																																
enumeration	26																																																																
enumeration	27																																																																
enumeration	28																																																																
enumeration	29																																																																
enumeration	30																																																																
enumeration	31																																																																
enumeration	32																																																																
enumeration	33																																																																
enumeration	35																																																																
enumeration	36																																																																
enumeration	37																																																																
enumeration	41																																																																
enumeration	42																																																																

enumeration	99
-------------	----

element **Altre_Spese_Type/Importo**

diagram					
namespace	urn:www.agenziaentrate.gov.it:specificheTecniche:sco:p73				
type	DatoNP_Type				
facets	<table border="1"> <tr> <td>Kind</td> <td>Value</td> </tr> <tr> <td>pattern</td> <td>[1-9]{1}[0-9]*</td> </tr> </table>	Kind	Value	pattern	[1-9]{1}[0-9]*
Kind	Value				
pattern	[1-9]{1}[0-9]*				

complexType **Altri_Dati_Type**

diagram	
namespace	urn:www.agenziaentrate.gov.it:specificheTecniche:sco:p73
children	<p> p73:ResiduoCreditoErogazioneCultura p73:ResiduoCreditoPrimaCasa p73:ResiduoCreditoOccupazione p73:ResiduoCreditoSisma p73:ResiduoCreditoFondiPensione p73:ResiduoCreditoMediazioni p73:TotSpeseSanitarieRateizzate p73:RedditoAgevolazioniFiscali p73:RedditoComplessivoAcconto p73:RigoDifferenzaAcconto p73:RedditiFondariNonImponibili p73:RedditoAbitazionePrincipalePertinenze p73:ResiduoDeduzioneSommeRestituite p73:ResiduoCreditoNegoziazione p73:CreditoErogazioneCultura </p>

element **Altri_Dati_Type/ResiduoCreditoErogazioneCultura**

diagram					
namespace	urn:www.agenziaentrate.gov.it:specificheTecniche:sco:p73				
type	DatoNP_Type				
facets	<table border="1"> <tr> <td>Kind</td> <td>Value</td> </tr> <tr> <td>pattern</td> <td>[1-9]{1}[0-9]*</td> </tr> </table>	Kind	Value	pattern	[1-9]{1}[0-9]*
Kind	Value				
pattern	[1-9]{1}[0-9]*				

element **Altri_Dati_Type/ResiduoCreditoPrimaCasa**

diagram					
namespace	urn:www.agenziaentrate.gov.it:specificheTecniche:sco:p73				
type	DatoNP_Type				
facets	<table border="1"> <tr> <td>Kind</td> <td>Value</td> </tr> <tr> <td>pattern</td> <td>[1-9]{1}[0-9]*</td> </tr> </table>	Kind	Value	pattern	[1-9]{1}[0-9]*
Kind	Value				
pattern	[1-9]{1}[0-9]*				

element **Altri_Dati_Type/ResiduoCreditoOccupazione**

diagram					
namespace	urn:www.agenziaentrate.gov.it:specificheTecniche:sco:p73				
type	DatoNP_Type				
facets	<table border="1"> <tr> <td>Kind</td> <td>Value</td> </tr> <tr> <td>pattern</td> <td>[1-9]{1}[0-9]*</td> </tr> </table>	Kind	Value	pattern	[1-9]{1}[0-9]*
Kind	Value				
pattern	[1-9]{1}[0-9]*				

element **Altri_Dati_Type/ResiduoCreditoSisma**

diagram					
namespace	urn:www.agenziaentrate.gov.it:specificheTecniche:sco:p73				
type	DatoNP_Type				
facets	<table border="1"> <tr> <td>Kind</td> <td>Value</td> </tr> <tr> <td>pattern</td> <td>[1-9]{1}[0-9]*</td> </tr> </table>	Kind	Value	pattern	[1-9]{1}[0-9]*
Kind	Value				
pattern	[1-9]{1}[0-9]*				

element **Altri_Dati_Type/ResiduoCreditoFondiPensione**

diagram					
namespace	urn:www.agenziaentrate.gov.it:specificheTecniche:sco:p73				
type	DatoNP_Type				
facets	<table border="1"> <tr> <td>Kind</td> <td>Value</td> </tr> <tr> <td>pattern</td> <td>[1-9]{1}[0-9]*</td> </tr> </table>	Kind	Value	pattern	[1-9]{1}[0-9]*
Kind	Value				
pattern	[1-9]{1}[0-9]*				

element **Altri_Dati_Type/ResiduoCreditoMediazioni**

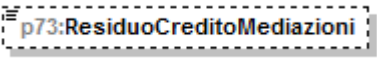
diagram	
namespace	urn:www.agenziaentrate.gov.it:specificheTecniche:sco:p73
type	DatoNP_Type
facets	Kind Value pattern [1-9]{1}[0-9]*

element **Altri_Dati_Type/TotSpeseSanitarieRateizzate**

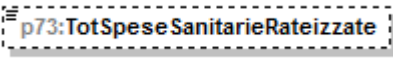
diagram	
namespace	urn:www.agenziaentrate.gov.it:specificheTecniche:sco:p73
type	DatoNP_Type
facets	Kind Value pattern [1-9]{1}[0-9]*

element **Altri_Dati_Type/RedditoAgevolazioniFiscali**

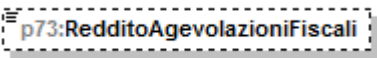
diagram	
namespace	urn:www.agenziaentrate.gov.it:specificheTecniche:sco:p73
type	DatoNP_Type
facets	Kind Value pattern [1-9]{1}[0-9]*

element **Altri_Dati_Type/RedditoComplessivoAcconto**

diagram	
namespace	urn:www.agenziaentrate.gov.it:specificheTecniche:sco:p73
type	DatoNP_Type
facets	Kind Value pattern [1-9]{1}[0-9]*

element **Altri_Dati_Type/RigoDifferenzaAcconto**

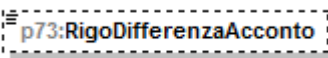
diagram	
namespace	urn:www.agenziaentrate.gov.it:specificheTecniche:sco:p73
type	DatoNU_Type
facets	Kind Value pattern (\-[1-9] [1-9])[0-9]*

element **Altri_Dati_Type/RedditiFondariNonImponibili**

diagram	 p73:RedditiFondariNonImponibili
namespace	urn:www.agenziaentrate.gov.it:specificheTecniche:sco:p73
type	DatoNP_Type
facets	Kind Value pattern [1-9]{1}[0-9]*

element **Altri_Dati_Type/RedditoAbitazionePrincipalePertinenze**

diagram	 p73:RedditoAbitazionePrincipale...
namespace	urn:www.agenziaentrate.gov.it:specificheTecniche:sco:p73
type	DatoNP_Type
facets	Kind Value pattern [1-9]{1}[0-9]*

element **Altri_Dati_Type/ResiduoDeduzioneSommeRestituite**

diagram	 p73:ResiduoDeduzioneSommeR...
namespace	urn:www.agenziaentrate.gov.it:specificheTecniche:sco:p73
type	DatoNP_Type
facets	Kind Value pattern [1-9]{1}[0-9]*

element **Altri_Dati_Type/ResiduoCreditoNegoziazione**

diagram	 p73:ResiduoCreditoNegoziazione
namespace	urn:www.agenziaentrate.gov.it:specificheTecniche:sco:p73
type	DatoNP_Type
facets	Kind Value pattern [1-9]{1}[0-9]*

element **Altri_Dati_Type/CreditoErogazioneCultura**

diagram	
namespace	urn:www.agenziaentrate.gov.it:specificheTecniche:sco:p73
type	p73:Cred_Erogazione_Cultura_Type
children	p73:RataAnnoPrec p73:RataAnno

complexType **Altri_Oneri_Type**

diagram	
namespace	urn:www.agenziaentrate.gov.it:specificheTecniche:sco:p73
children	p73:Codice p73:Importo

element **Altri_Oneri_Type/Codice**

diagram															
namespace	urn:www.agenziaentrate.gov.it:specificheTecniche:sco:p73														
type	p73:Codice Altri_Oneri_Type														
facets	<table border="1"> <thead> <tr> <th>Kind</th> <th>Value</th> </tr> </thead> <tbody> <tr> <td>pattern</td> <td>[1-9]{1}[0-9]*</td> </tr> <tr> <td>enumeration</td> <td>6</td> </tr> <tr> <td>enumeration</td> <td>7</td> </tr> <tr> <td>enumeration</td> <td>8</td> </tr> <tr> <td>enumeration</td> <td>9</td> </tr> <tr> <td>enumeration</td> <td>11</td> </tr> </tbody> </table>	Kind	Value	pattern	[1-9]{1}[0-9]*	enumeration	6	enumeration	7	enumeration	8	enumeration	9	enumeration	11
Kind	Value														
pattern	[1-9]{1}[0-9]*														
enumeration	6														
enumeration	7														
enumeration	8														
enumeration	9														
enumeration	11														

element **Altri_Oneri_Type/Importo**

diagram					
namespace	urn:www.agenziaentrate.gov.it:specificheTecniche:sco:p73				
type	DatoNP_Type				
facets	<table border="1"> <thead> <tr> <th>Kind</th> <th>Value</th> </tr> </thead> <tbody> <tr> <td>pattern</td> <td>[1-9]{1}[0-9]*</td> </tr> </tbody> </table>	Kind	Value	pattern	[1-9]{1}[0-9]*
Kind	Value				
pattern	[1-9]{1}[0-9]*				

complexType Altri_Reddito_Ass_Lav_Type

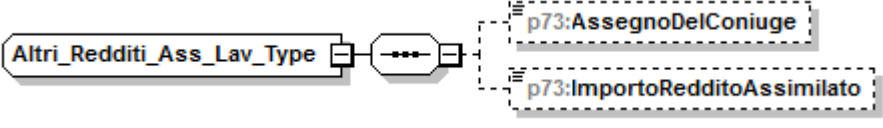
diagram	
namespace	urn:www.agenziaentrate.gov.it:specificheTecniche:sco:p73
children	p73:AssegnoDelConiuge p73:ImportoRedditoAssimilato

element Altri_Reddito_Ass_Lav_Type/AssegnoDelConiuge

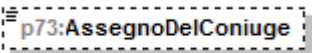
diagram					
namespace	urn:www.agenziaentrate.gov.it:specificheTecniche:sco:p73				
type	DatoCB_Type				
facets	<table border="1"> <tr> <th>Kind</th> <th>Value</th> </tr> <tr> <td>pattern</td> <td>[01]</td> </tr> </table>	Kind	Value	pattern	[01]
Kind	Value				
pattern	[01]				

element Altri_Reddito_Ass_Lav_Type/ImportoRedditoAssimilato

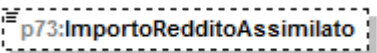
diagram					
namespace	urn:www.agenziaentrate.gov.it:specificheTecniche:sco:p73				
type	DatoNP_Type				
facets	<table border="1"> <tr> <th>Kind</th> <th>Value</th> </tr> <tr> <td>pattern</td> <td>[1-9]{1}[0-9]*</td> </tr> </table>	Kind	Value	pattern	[1-9]{1}[0-9]*
Kind	Value				
pattern	[1-9]{1}[0-9]*				

complexType Altri_Reddito_Diversi_Detr_Type

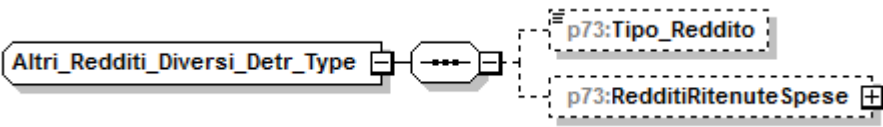
diagram	
namespace	urn:www.agenziaentrate.gov.it:specificheTecniche:sco:p73
children	p73:Tipo_Reddito p73:RedditiRitenuteSpese

element Altri_Reddito_Diversi_Detr_Type/Tipo_Reddito

diagram									
namespace	urn:www.agenziaentrate.gov.it:specificheTecniche:sco:p73								
type	p73:Tipo_Reddito_Da1a4_Type								
facets	<table border="1"> <tr> <th>Kind</th> <th>Value</th> </tr> <tr> <td>pattern</td> <td>[1-9]</td> </tr> <tr> <td>enumeration</td> <td>1</td> </tr> <tr> <td>enumeration</td> <td>2</td> </tr> </table>	Kind	Value	pattern	[1-9]	enumeration	1	enumeration	2
Kind	Value								
pattern	[1-9]								
enumeration	1								
enumeration	2								

	enumeration	3
	enumeration	4

element **Altri_Reddito_Diversi_Detr_Type/RedditoRitenuteSpese**

diagram	
namespace	urn:www.agenziaentrate.gov.it:specificheTecniche:sco:p73
type	p73:Redditi_Ritenute_Spese_Type
children	p73:ImportoRedditi p73:ImportoRitenute p73:ImportoSpese

complexType **Altri_Reddito_Diversi_Type**

diagram	
namespace	urn:www.agenziaentrate.gov.it:specificheTecniche:sco:p73
children	p73:TipoReddito p73:RedditoRitenuteSpese

element **Altri_Reddito_Diversi_Type/TipoReddito**

diagram																							
namespace	urn:www.agenziaentrate.gov.it:specificheTecniche:sco:p73																						
type	p73:Tipo_Reddito_Da1a9_Type																						
facets	<table border="1"> <thead> <tr> <th>Kind</th> <th>Value</th> </tr> </thead> <tbody> <tr> <td>pattern</td> <td>[1-9]{1}[0-9]*</td> </tr> <tr> <td>enumeration</td> <td>1</td> </tr> <tr> <td>enumeration</td> <td>2</td> </tr> <tr> <td>enumeration</td> <td>3</td> </tr> <tr> <td>enumeration</td> <td>4</td> </tr> <tr> <td>enumeration</td> <td>5</td> </tr> <tr> <td>enumeration</td> <td>6</td> </tr> <tr> <td>enumeration</td> <td>7</td> </tr> <tr> <td>enumeration</td> <td>8</td> </tr> <tr> <td>enumeration</td> <td>9</td> </tr> </tbody> </table>	Kind	Value	pattern	[1-9]{1}[0-9]*	enumeration	1	enumeration	2	enumeration	3	enumeration	4	enumeration	5	enumeration	6	enumeration	7	enumeration	8	enumeration	9
Kind	Value																						
pattern	[1-9]{1}[0-9]*																						
enumeration	1																						
enumeration	2																						
enumeration	3																						
enumeration	4																						
enumeration	5																						
enumeration	6																						
enumeration	7																						
enumeration	8																						
enumeration	9																						

element Altri_Reddito_Diversi_Type/RedditoRitenuteSpese

diagram	
namespace	urn:www.agenziaentrate.gov.it:specificheTecniche:sco:p73
type	p73:RedditoRitenuteSpese_Type
children	p73:ImportoReddito p73:ImportoRitenute p73:ImportoSpese

complexType Altri_Reddito_Lavoro_Autonomo_Type

diagram	
namespace	urn:www.agenziaentrate.gov.it:specificheTecniche:sco:p73
children	p73:TipoReddito p73:RedditoRitenute

element Altri_Reddito_Lavoro_Autonomo_Type/TipoReddito

diagram											
namespace	urn:www.agenziaentrate.gov.it:specificheTecniche:sco:p73										
type	p73:TipoRedditoDa1a3_Type										
facets	<table border="0"> <thead> <tr> <th>Kind</th> <th>Value</th> </tr> </thead> <tbody> <tr> <td>pattern</td> <td>[1-9]</td> </tr> <tr> <td>enumeration</td> <td>1</td> </tr> <tr> <td>enumeration</td> <td>2</td> </tr> <tr> <td>enumeration</td> <td>3</td> </tr> </tbody> </table>	Kind	Value	pattern	[1-9]	enumeration	1	enumeration	2	enumeration	3
Kind	Value										
pattern	[1-9]										
enumeration	1										
enumeration	2										
enumeration	3										

element Altri_Reddito_Lavoro_Autonomo_Type/RedditoRitenute

diagram	
namespace	urn:www.agenziaentrate.gov.it:specificheTecniche:sco:p73
type	p73:RedditoRitenute_Type

children	p73:ImportoRedditi p73:ImportoRitenute
----------	--

complexType Altri_Redditi_Type

diagram	
namespace	urn:www.agenziaentrate.gov.it:specificheTecniche:sco:p73
children	p73:Modulo

element Altri_Redditi_Type/Modulo

diagram	
namespace	urn:www.agenziaentrate.gov.it:specificheTecniche:sco:p73
type	p73:Modulo Altri Redditi Type
children	p73:RedditiDiCapitale p73:RedditiTassazioneSeparata

complexType Altri_Redditi_Utili_Type

diagram	
namespace	urn:www.agenziaentrate.gov.it:specificheTecniche:sco:p73
children	p73:Tipo_Reddito p73:RedditiRitenute

element Altri_Redditi_Utili_Type/Tipo_Reddito

diagram																	
namespace	urn:www.agenziaentrate.gov.it:specificheTecniche:sco:p73																
type	p73:Tipo_Reddito Da1a8 Type																
facets	<table border="1"> <thead> <tr> <th>Kind</th> <th>Value</th> </tr> </thead> <tbody> <tr> <td>pattern</td> <td>[1-9]{1}[0-9]*</td> </tr> <tr> <td>enumeration</td> <td>1</td> </tr> <tr> <td>enumeration</td> <td>2</td> </tr> <tr> <td>enumeration</td> <td>3</td> </tr> <tr> <td>enumeration</td> <td>4</td> </tr> <tr> <td>enumeration</td> <td>5</td> </tr> <tr> <td>enumeration</td> <td>6</td> </tr> </tbody> </table>	Kind	Value	pattern	[1-9]{1}[0-9]*	enumeration	1	enumeration	2	enumeration	3	enumeration	4	enumeration	5	enumeration	6
Kind	Value																
pattern	[1-9]{1}[0-9]*																
enumeration	1																
enumeration	2																
enumeration	3																
enumeration	4																
enumeration	5																
enumeration	6																

	enumeration 7 enumeration 8
--	--------------------------------

element **Altri_Reddito_Utili_Type/RedditoRitenute**

diagram	
namespace	urn:www.agenziaentrate.gov.it:specificheTecniche:sco:p73
type	p73:Reddito Ritenute Type
children	p73:ImportoReddito p73:ImportoRitenute

complexType **Assegno_Coniuge_Type**

diagram	
namespace	urn:www.agenziaentrate.gov.it:specificheTecniche:sco:p73
children	p73:CodiceFiscale p73:Importo

element **Assegno_Coniuge_Type/CodiceFiscale**

diagram					
namespace	urn:www.agenziaentrate.gov.it:specificheTecniche:sco:p73				
type	DatoCF Type				
facets	<table border="1"> <thead> <tr> <th>Kind</th> <th>Value</th> </tr> </thead> <tbody> <tr> <td>pattern</td> <td>[0-9]{11}[A-Z]{6}0-9LMNPQRSTUUV{2}[A-Z]{1}0-9LMNPQRSTUUV{2}[A-Z]{1}0-9LMNPQRSTUUV{3}[A-Z]{1}</td> </tr> </tbody> </table>	Kind	Value	pattern	[0-9]{11}[A-Z]{6}0-9LMNPQRSTUUV{2}[A-Z]{1}0-9LMNPQRSTUUV{2}[A-Z]{1}0-9LMNPQRSTUUV{3}[A-Z]{1}
Kind	Value				
pattern	[0-9]{11}[A-Z]{6}0-9LMNPQRSTUUV{2}[A-Z]{1}0-9LMNPQRSTUUV{2}[A-Z]{1}0-9LMNPQRSTUUV{3}[A-Z]{1}				

element **Assegno_Coniuge_Type/Importo**

diagram					
namespace	urn:www.agenziaentrate.gov.it:specificheTecniche:sco:p73				
type	DatoNP Type				
facets	<table border="1"> <thead> <tr> <th>Kind</th> <th>Value</th> </tr> </thead> <tbody> <tr> <td>pattern</td> <td>[1-9]{1}[0-9]*</td> </tr> </tbody> </table>	Kind	Value	pattern	[1-9]{1}[0-9]*
Kind	Value				
pattern	[1-9]{1}[0-9]*				

complexType **Bonus_Irpef_Type**

diagram	
namespace	urn:www.agenziaentrate.gov.it:specificheTecniche:sco:p73
children	p73:CodiceBonus p73:BonusErogato p73:Esenzione p73:QuotaTfr

element **Bonus_Irpef_Type/CodiceBonus**

diagram									
namespace	urn:www.agenziaentrate.gov.it:specificheTecniche:sco:p73								
type	restriction of DatoN1_Type								
facets	<table border="0"> <tr> <td>Kind</td> <td>Value</td> </tr> <tr> <td>pattern</td> <td>[1-9]</td> </tr> <tr> <td>enumeration</td> <td>1</td> </tr> <tr> <td>enumeration</td> <td>2</td> </tr> </table>	Kind	Value	pattern	[1-9]	enumeration	1	enumeration	2
Kind	Value								
pattern	[1-9]								
enumeration	1								
enumeration	2								

element **Bonus_Irpef_Type/BonusErogato**

diagram					
namespace	urn:www.agenziaentrate.gov.it:specificheTecniche:sco:p73				
type	DatoNP_Type				
facets	<table border="0"> <tr> <td>Kind</td> <td>Value</td> </tr> <tr> <td>pattern</td> <td>[1-9]{1}[0-9]*</td> </tr> </table>	Kind	Value	pattern	[1-9]{1}[0-9]*
Kind	Value				
pattern	[1-9]{1}[0-9]*				

element **Bonus_Irpef_Type/Esenzione**

diagram	
namespace	urn:www.agenziaentrate.gov.it:specificheTecniche:sco:p73
type	p73:Esenzione Bonus_Type
children	p73:TipologiaEsenzione p73:ParteRedditoEsente

element **Bonus_Irpef_Type/QuotaTfr**

diagram					
namespace	urn:www.agenziaentrate.gov.it:specificheTecniche:sco:p73				
type	DatoNP_Type				
facets	<table border="1"> <tr> <td>Kind</td> <td>Value</td> </tr> <tr> <td>pattern</td> <td>[1-9]{1}[0-9]*</td> </tr> </table>	Kind	Value	pattern	[1-9]{1}[0-9]*
Kind	Value				
pattern	[1-9]{1}[0-9]*				

complexType **Casella_Acconto_Type**

diagram	
namespace	urn:www.agenziaentrate.gov.it:specificheTecniche:sco:p73
children	p73:Casella p73:ImportoMisuralInferiore

element **Casella_Acconto_Type/Casella**

diagram					
namespace	urn:www.agenziaentrate.gov.it:specificheTecniche:sco:p73				
type	DatoCB_Type				
facets	<table border="1"> <tr> <td>Kind</td> <td>Value</td> </tr> <tr> <td>pattern</td> <td>[01]</td> </tr> </table>	Kind	Value	pattern	[01]
Kind	Value				
pattern	[01]				

element **Casella_Acconto_Type/ImportoMisuralInferiore**

diagram					
namespace	urn:www.agenziaentrate.gov.it:specificheTecniche:sco:p73				
type	DatoNP_Type				
facets	<table border="1"> <tr> <td>Kind</td> <td>Value</td> </tr> <tr> <td>pattern</td> <td>[1-9]{1}[0-9]*</td> </tr> </table>	Kind	Value	pattern	[1-9]{1}[0-9]*
Kind	Value				
pattern	[1-9]{1}[0-9]*				

complexType **Cedolare_Secca_Type**

diagram	
namespace	urn:www.agenziaentrate.gov.it:specificheTecniche:sco:p73

children	p73:CedolareDovuta p73:EccedenzaCedolareSecca p73:AccontoCedolare
----------	---

element Cedolare_Secca_Type/CedolareDovuta

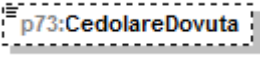
diagram					
namespace	urn:www.agenziaentrate.gov.it:specificheTecniche:sco:p73				
type	DatoNP_Type				
facets	<table border="0"> <tr> <td>Kind</td> <td>Value</td> </tr> <tr> <td>pattern</td> <td>[1-9]{1}[0-9]*</td> </tr> </table>	Kind	Value	pattern	[1-9]{1}[0-9]*
Kind	Value				
pattern	[1-9]{1}[0-9]*				

element Cedolare_Secca_Type/EccedenzaCedolareSecca

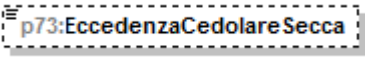
diagram					
namespace	urn:www.agenziaentrate.gov.it:specificheTecniche:sco:p73				
type	DatoNU_Type				
facets	<table border="0"> <tr> <td>Kind</td> <td>Value</td> </tr> <tr> <td>pattern</td> <td>(\-[1-9] [1-9])[0-9]*</td> </tr> </table>	Kind	Value	pattern	(\-[1-9] [1-9])[0-9]*
Kind	Value				
pattern	(\-[1-9] [1-9])[0-9]*				

element Cedolare_Secca_Type/AccontoCedolare

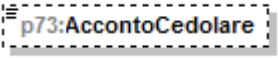
diagram					
namespace	urn:www.agenziaentrate.gov.it:specificheTecniche:sco:p73				
type	DatoNP_Type				
facets	<table border="0"> <tr> <td>Kind</td> <td>Value</td> </tr> <tr> <td>pattern</td> <td>[1-9]{1}[0-9]*</td> </tr> </table>	Kind	Value	pattern	[1-9]{1}[0-9]*
Kind	Value				
pattern	[1-9]{1}[0-9]*				

complexType **Conguaglio_Type**

diagram	
namespace	urn:www.agenziaentrate.gov.it:specificheTecniche:sco:p73
children	p73:NumeroRate p73:ImportoTrattenutoSaldo p73:ImportoTrattenutoAcconto p73:ImportoDaVersareF24Saldo p73:ImportoDaVersareF24Acconto p73:ImportoRimborsato p73:ImportoRimborsatoAgenzia p73:OpzioneInformativa

element **Conguaglio_Type/NumeroRate**

diagram																	
namespace	urn:www.agenziaentrate.gov.it:specificheTecniche:sco:p73																
type	restriction of DatoN1_Type																
facets	<table border="1"> <thead> <tr> <th>Kind</th> <th>Value</th> </tr> </thead> <tbody> <tr> <td>pattern</td> <td>[1-9]</td> </tr> <tr> <td>enumeration</td> <td>2</td> </tr> <tr> <td>enumeration</td> <td>3</td> </tr> <tr> <td>enumeration</td> <td>4</td> </tr> <tr> <td>enumeration</td> <td>5</td> </tr> <tr> <td>enumeration</td> <td>6</td> </tr> <tr> <td>enumeration</td> <td>7</td> </tr> </tbody> </table>	Kind	Value	pattern	[1-9]	enumeration	2	enumeration	3	enumeration	4	enumeration	5	enumeration	6	enumeration	7
Kind	Value																
pattern	[1-9]																
enumeration	2																
enumeration	3																
enumeration	4																
enumeration	5																
enumeration	6																
enumeration	7																

element **Conguaglio_Type/ImportoTrattenutoSaldo**

diagram					
namespace	urn:www.agenziaentrate.gov.it:specificheTecniche:sco:p73				
type	DatoNP_Type				
facets	<table border="1"> <thead> <tr> <th>Kind</th> <th>Value</th> </tr> </thead> <tbody> <tr> <td>pattern</td> <td>[1-9]{1}[0-9]*</td> </tr> </tbody> </table>	Kind	Value	pattern	[1-9]{1}[0-9]*
Kind	Value				
pattern	[1-9]{1}[0-9]*				

element Conguaglio_Type/ImportoTrattenutoAcconto

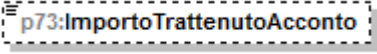
diagram					
namespace	urn:www.agenziaentrate.gov.it:specificheTecniche:sco:p73				
type	DatoNP_Type				
facets	<table border="1"> <tr> <td>Kind</td> <td>Value</td> </tr> <tr> <td>pattern</td> <td>[1-9]{1}[0-9]*</td> </tr> </table>	Kind	Value	pattern	[1-9]{1}[0-9]*
Kind	Value				
pattern	[1-9]{1}[0-9]*				

element Conguaglio_Type/ImportoDaVersareF24Saldo

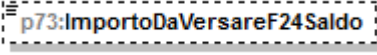
diagram					
namespace	urn:www.agenziaentrate.gov.it:specificheTecniche:sco:p73				
type	DatoNP_Type				
facets	<table border="1"> <tr> <td>Kind</td> <td>Value</td> </tr> <tr> <td>pattern</td> <td>[1-9]{1}[0-9]*</td> </tr> </table>	Kind	Value	pattern	[1-9]{1}[0-9]*
Kind	Value				
pattern	[1-9]{1}[0-9]*				

element Conguaglio_Type/ImportoDaVersareF24Acconto

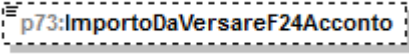
diagram					
namespace	urn:www.agenziaentrate.gov.it:specificheTecniche:sco:p73				
type	DatoNP_Type				
facets	<table border="1"> <tr> <td>Kind</td> <td>Value</td> </tr> <tr> <td>pattern</td> <td>[1-9]{1}[0-9]*</td> </tr> </table>	Kind	Value	pattern	[1-9]{1}[0-9]*
Kind	Value				
pattern	[1-9]{1}[0-9]*				

element Conguaglio_Type/ImportoRimborsato

diagram					
namespace	urn:www.agenziaentrate.gov.it:specificheTecniche:sco:p73				
type	DatoNP_Type				
facets	<table border="1"> <tr> <td>Kind</td> <td>Value</td> </tr> <tr> <td>pattern</td> <td>[1-9]{1}[0-9]*</td> </tr> </table>	Kind	Value	pattern	[1-9]{1}[0-9]*
Kind	Value				
pattern	[1-9]{1}[0-9]*				

element Conguaglio_Type/ImportoRimborsatoAgenzia

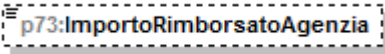
diagram					
namespace	urn:www.agenziaentrate.gov.it:specificheTecniche:sco:p73				
type	DatoNP_Type				
facets	<table border="1"> <tr> <td>Kind</td> <td>Value</td> </tr> <tr> <td>pattern</td> <td>[1-9]{1}[0-9]*</td> </tr> </table>	Kind	Value	pattern	[1-9]{1}[0-9]*
Kind	Value				
pattern	[1-9]{1}[0-9]*				

element Conguaglio_Type/OpzioneInformativa

diagram	
namespace	urn:www.agenziaentrate.gov.it:specificheTecniche:sco:p73
type	DatoCB_Type
facets	Kind Value pattern [01]

complexType Contributi_Previdenza_Complementare_Type

diagram	
namespace	urn:www.agenziaentrate.gov.it:specificheTecniche:sco:p73
children	p73:EsclusiDalSostituto p73:NonEsclusiDalSostituto

element Contributi_Previdenza_Complementare_Type/EsclusiDalSostituto

diagram	
namespace	urn:www.agenziaentrate.gov.it:specificheTecniche:sco:p73
type	DatoNP_Type
facets	Kind Value pattern [1-9]{1}[0-9]*

element Contributi_Previdenza_Complementare_Type/NonEsclusiDalSostituto

diagram	
namespace	urn:www.agenziaentrate.gov.it:specificheTecniche:sco:p73
type	DatoNP_Type
facets	Kind Value pattern [1-9]{1}[0-9]*

complexType Contributo_Solidarieta_Type

diagram	
namespace	urn:www.agenziaentrate.gov.it:specificheTecniche:sco:p73

children	p73:ImponibileContributo p73:ContributoDovuto p73:ContributoCertificaz
----------	--

element Contributo_Solidarieta_Type/ImponibileContributo

diagram	
namespace	urn:www.agenziaentrate.gov.it:specificheTecniche:sco:p73
type	DatoNP_Type
facets	Kind Value pattern [1-9]{1}[0-9]*

element Contributo_Solidarieta_Type/ContributoDovuto

diagram	
namespace	urn:www.agenziaentrate.gov.it:specificheTecniche:sco:p73
type	DatoNP_Type
facets	Kind Value pattern [1-9]{1}[0-9]*

element Contributo_Solidarieta_Type/ContributoCertificaz

diagram	
namespace	urn:www.agenziaentrate.gov.it:specificheTecniche:sco:p73
type	DatoNP_Type
facets	Kind Value pattern [1-9]{1}[0-9]*

complexType Cred_Erogazione_Cultura_Type

diagram	
namespace	urn:www.agenziaentrate.gov.it:specificheTecniche:sco:p73
children	p73:RataAnnoPrec p73:RataAnno

element Cred_Erogazione_Cultura_Type/RataAnnoPrec

diagram	
namespace	urn:www.agenziaentrate.gov.it:specificheTecniche:sco:p73
type	DatoNP_Type

facets	Kind pattern	Value [1-9]{1}[0-9]*
--------	-----------------	-------------------------

element Cred_Erogazione_Cultura_Type/RataAnno

diagram		
namespace	urn:www.agenziaentrate.gov.it:specificheTecniche:sco:p73	
type	DatoNP_Type	
facets	Kind pattern	Value [1-9]{1}[0-9]*

complexType Cred_Imp_Estero_Type

diagram		
namespace	urn:www.agenziaentrate.gov.it:specificheTecniche:sco:p73	
children	p73:Anno p73:TotCredito p73:CreditoStato	

element Cred_Imp_Estero_Type/Anno

diagram		
namespace	urn:www.agenziaentrate.gov.it:specificheTecniche:sco:p73	
type	DatoDA_Type	
facets	Kind pattern	Value (18 19 20)[0-9]{2}

element Cred_Imp_Estero_Type/TotCredito

diagram		
namespace	urn:www.agenziaentrate.gov.it:specificheTecniche:sco:p73	
type	DatoNP_Type	
facets	Kind pattern	Value [1-9]{1}[0-9]*

element **Cred_Imp_Estero_Type/CreditoStato**

diagram	
namespace	urn:www.agenziaentrate.gov.it:specificheTecniche:sco:p73
type	p73:Credito_Stato_Type
children	p73:Stato p73:Credito

complexType **Crediti_F24_Type**

diagram	
namespace	urn:www.agenziaentrate.gov.it:specificheTecniche:sco:p73
children	p73:Credlrpef p73:CredlrpefDipNoSostituto p73:CodAddReg p73:CredAddReg p73:CredAddRegDipNoSostituto p73:CodiceAddCom p73:CredAddCom p73:CredAddComDipNoSostituto p73:CredCedolare p73:CredCedolareDipNoSostituto p73:CredTassSeparDipNoSostitu... p73:CredProduttivitaDipNoSostit... p73:CredSolidarietaDipNoSostitu... p73:Totale p73:TotaleDipNoSostituto

element Crediti_F24_Type/Credlrpef

diagram					
namespace	urn:www.agenziaentrate.gov.it:specificheTecniche:sco:p73				
type	DatoNP_Type				
facets	<table border="0"> <tr> <td>Kind</td> <td>Value</td> </tr> <tr> <td>pattern</td> <td>[1-9]{1}[0-9]*</td> </tr> </table>	Kind	Value	pattern	[1-9]{1}[0-9]*
Kind	Value				
pattern	[1-9]{1}[0-9]*				

element Crediti_F24_Type/CredlrpefDipNoSostituto

diagram					
namespace	urn:www.agenziaentrate.gov.it:specificheTecniche:sco:p73				
type	DatoNP_Type				
facets	<table border="0"> <tr> <td>Kind</td> <td>Value</td> </tr> <tr> <td>pattern</td> <td>[1-9]{1}[0-9]*</td> </tr> </table>	Kind	Value	pattern	[1-9]{1}[0-9]*
Kind	Value				
pattern	[1-9]{1}[0-9]*				

element Crediti_F24_Type/CodAddReg

diagram																																															
namespace	urn:www.agenziaentrate.gov.it:specificheTecniche:sco:p73																																														
type	Codice Regione Type																																														
facets	<table border="0"> <tr> <td>Kind</td> <td>Value</td> </tr> <tr> <td>pattern</td> <td>([0-9A-Z-] &quot;){1}([0-9A-Z&amp;] ' \"- \\. / ° √ \\(\\) À É Ê Ï Ò Ù Û &quot;; \\ \\ \\ +)*</td> </tr> <tr> <td>enumeration</td> <td>1</td> </tr> <tr> <td>enumeration</td> <td>2</td> </tr> <tr> <td>enumeration</td> <td>3</td> </tr> <tr> <td>enumeration</td> <td>4</td> </tr> <tr> <td>enumeration</td> <td>5</td> </tr> <tr> <td>enumeration</td> <td>6</td> </tr> <tr> <td>enumeration</td> <td>7</td> </tr> <tr> <td>enumeration</td> <td>8</td> </tr> <tr> <td>enumeration</td> <td>9</td> </tr> <tr> <td>enumeration</td> <td>10</td> </tr> <tr> <td>enumeration</td> <td>11</td> </tr> <tr> <td>enumeration</td> <td>12</td> </tr> <tr> <td>enumeration</td> <td>13</td> </tr> <tr> <td>enumeration</td> <td>14</td> </tr> <tr> <td>enumeration</td> <td>15</td> </tr> <tr> <td>enumeration</td> <td>16</td> </tr> <tr> <td>enumeration</td> <td>17</td> </tr> <tr> <td>enumeration</td> <td>18</td> </tr> <tr> <td>enumeration</td> <td>19</td> </tr> <tr> <td>enumeration</td> <td>20</td> </tr> <tr> <td>enumeration</td> <td>21</td> </tr> </table>	Kind	Value	pattern	([0-9A-Z-] "){1}([0-9A-Z&] ' \"- \\. / ° √ \\(\\) À É Ê Ï Ò Ù Û "; \\ \\ \\ +)*	enumeration	1	enumeration	2	enumeration	3	enumeration	4	enumeration	5	enumeration	6	enumeration	7	enumeration	8	enumeration	9	enumeration	10	enumeration	11	enumeration	12	enumeration	13	enumeration	14	enumeration	15	enumeration	16	enumeration	17	enumeration	18	enumeration	19	enumeration	20	enumeration	21
Kind	Value																																														
pattern	([0-9A-Z-] "){1}([0-9A-Z&] ' \"- \\. / ° √ \\(\\) À É Ê Ï Ò Ù Û "; \\ \\ \\ +)*																																														
enumeration	1																																														
enumeration	2																																														
enumeration	3																																														
enumeration	4																																														
enumeration	5																																														
enumeration	6																																														
enumeration	7																																														
enumeration	8																																														
enumeration	9																																														
enumeration	10																																														
enumeration	11																																														
enumeration	12																																														
enumeration	13																																														
enumeration	14																																														
enumeration	15																																														
enumeration	16																																														
enumeration	17																																														
enumeration	18																																														
enumeration	19																																														
enumeration	20																																														
enumeration	21																																														

element Crediti_F24_Type/CredAddReg

diagram	
namespace	urn:www.agenziaentrate.gov.it:specificheTecniche:sco:p73
type	DatoNP_Type
facets	Kind Value pattern [1-9]{1}[0-9]*

element Crediti_F24_Type/CredAddRegDipNoSostituto

diagram	
namespace	urn:www.agenziaentrate.gov.it:specificheTecniche:sco:p73
type	DatoNP_Type
facets	Kind Value pattern [1-9]{1}[0-9]*

element Crediti_F24_Type/CodiceAddCom

diagram	
namespace	urn:www.agenziaentrate.gov.it:specificheTecniche:sco:p73
type	DatoAN_Type
facets	Kind Value pattern ([0-9A-Z\-\-]\"){1}([0-9A-Z&:] '\- \- , / ° °\(\) \) À É È Ì Ò Ù Û " \ \ \ +)*

element Crediti_F24_Type/CredAddCom

diagram	
namespace	urn:www.agenziaentrate.gov.it:specificheTecniche:sco:p73
type	DatoNP_Type
facets	Kind Value pattern [1-9]{1}[0-9]*

element Crediti_F24_Type/CredAddComDipNoSostituto

diagram	
namespace	urn:www.agenziaentrate.gov.it:specificheTecniche:sco:p73
type	DatoNP_Type
facets	Kind Value pattern [1-9]{1}[0-9]*

element **Crediti_F24_Type/CredCedolare**

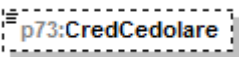
diagram	
namespace	urn:www.agenziaentrate.gov.it:specificheTecniche:sco:p73
type	DatoNP_Type
facets	Kind Value pattern [1-9]{1}[0-9]*

element **Crediti_F24_Type/CredCedolareDipNoSostituto**

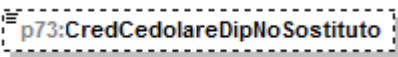
diagram	
namespace	urn:www.agenziaentrate.gov.it:specificheTecniche:sco:p73
type	DatoNP_Type
facets	Kind Value pattern [1-9]{1}[0-9]*

element **Crediti_F24_Type/CredTassSeparDipNoSostituto**

diagram	
namespace	urn:www.agenziaentrate.gov.it:specificheTecniche:sco:p73
type	DatoNP_Type
facets	Kind Value pattern [1-9]{1}[0-9]*

element **Crediti_F24_Type/CredProduttivitaDipNoSostituto**

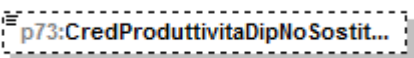
diagram	
namespace	urn:www.agenziaentrate.gov.it:specificheTecniche:sco:p73
type	DatoNP_Type
facets	Kind Value pattern [1-9]{1}[0-9]*

element **Crediti_F24_Type/CredSolidarietaDipNoSostituto**

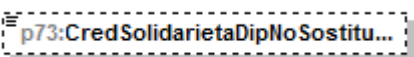
diagram	
namespace	urn:www.agenziaentrate.gov.it:specificheTecniche:sco:p73
type	DatoNP_Type
facets	Kind Value pattern [1-9]{1}[0-9]*

element Crediti_F24_Type/Totale

diagram					
namespace	urn:www.agenziaentrate.gov.it:specificheTecniche:sco:p73				
type	DatoNP_Type				
facets	<table border="1"> <tr> <td>Kind</td> <td>Value</td> </tr> <tr> <td>pattern</td> <td>[1-9]{1}[0-9]*</td> </tr> </table>	Kind	Value	pattern	[1-9]{1}[0-9]*
Kind	Value				
pattern	[1-9]{1}[0-9]*				

element Crediti_F24_Type/TotaleDipNoSostituto

diagram					
namespace	urn:www.agenziaentrate.gov.it:specificheTecniche:sco:p73				
type	DatoNP_Type				
facets	<table border="1"> <tr> <td>Kind</td> <td>Value</td> </tr> <tr> <td>pattern</td> <td>[1-9]{1}[0-9]*</td> </tr> </table>	Kind	Value	pattern	[1-9]{1}[0-9]*
Kind	Value				
pattern	[1-9]{1}[0-9]*				

complexType Crediti_Imposta_Altri_Sisma_Abruzzo_Type

diagram	
namespace	urn:www.agenziaentrate.gov.it:specificheTecniche:sco:p73
children	p73:Impresa_Professione p73:CreditoImmobileSismaAbruzzo p73:Rateazione

element Crediti_Imposta_Altri_Sisma_Abruzzo_Type/Impresa_Professione

diagram					
namespace	urn:www.agenziaentrate.gov.it:specificheTecniche:sco:p73				
type	DatoCB_Type				
facets	<table border="1"> <tr> <td>Kind</td> <td>Value</td> </tr> <tr> <td>pattern</td> <td>[01]</td> </tr> </table>	Kind	Value	pattern	[01]
Kind	Value				
pattern	[01]				

element Crediti_Imposta_Altri_Sisma_Abruzzo_Type/CreditoImmobileSismaAbruzzo

diagram	
namespace	urn:www.agenziaentrate.gov.it:specificheTecniche:sco:p73
type	p73:Credito_Immobile_Sisma_Abruzzo_Type
children	p73:CodiceFiscale p73:NumeroRata p73:TotaleCredito

element Crediti_Imposta_Altri_Sisma_Abruzzo_Type/Rateazione

diagram									
namespace	urn:www.agenziaentrate.gov.it:specificheTecniche:sco:p73								
type	p73:Numero_Rate5o10_Type								
facets	<table border="1"> <thead> <tr> <th>Kind</th> <th>Value</th> </tr> </thead> <tbody> <tr> <td>pattern</td> <td>[1-9]{1}[0-9]*</td> </tr> <tr> <td>enumeration</td> <td>5</td> </tr> <tr> <td>enumeration</td> <td>10</td> </tr> </tbody> </table>	Kind	Value	pattern	[1-9]{1}[0-9]*	enumeration	5	enumeration	10
Kind	Value								
pattern	[1-9]{1}[0-9]*								
enumeration	5								
enumeration	10								

complexType Crediti_Imposta_Fabbicati_Type

diagram	
namespace	urn:www.agenziaentrate.gov.it:specificheTecniche:sco:p73
children	p73:ResiduoFabbicati p73:CanoniLocazioneNonPercepiti

element Crediti_Imposta_Fabbicati_Type/ResiduoFabbicati

diagram	
namespace	urn:www.agenziaentrate.gov.it:specificheTecniche:sco:p73

type	p73:Residuo_Fabbricati_Type
children	p73:ResiduoPrecedenteDichiarazione p73:CreditoAnno p73:DiCuiCompensatoF24

element Crediti_Imposta_Fabbricati_Type/CanoniLocazioneNonPercepiti

diagram					
namespace	urn:www.agenziaentrate.gov.it:specificheTecniche:sco:p73				
type	DatoNP_Type				
facets	<table border="1"> <thead> <tr> <th>Kind</th> <th>Value</th> </tr> </thead> <tbody> <tr> <td>pattern</td> <td>[1-9]{1}[0-9]*</td> </tr> </tbody> </table>	Kind	Value	pattern	[1-9]{1}[0-9]*
Kind	Value				
pattern	[1-9]{1}[0-9]*				

complexType Crediti_Imposta_Fondi_Pensione_Type

diagram	
namespace	urn:www.agenziaentrate.gov.it:specificheTecniche:sco:p73
children	p73:AnnoAnticipazione p73:Reintegro p73:SommaReintegrata p73:CreditoAnno

element Crediti_Imposta_Fondi_Pensione_Type/AnnoAnticipazione

diagram																							
namespace	urn:www.agenziaentrate.gov.it:specificheTecniche:sco:p73																						
type	p73:Anno_Anticipazione_Fondo_Pensione_Type																						
facets	<table border="1"> <thead> <tr> <th>Kind</th> <th>Value</th> </tr> </thead> <tbody> <tr> <td>pattern</td> <td>[1-9]{1}[0-9]*</td> </tr> <tr> <td>enumeration</td> <td>2007</td> </tr> <tr> <td>enumeration</td> <td>2008</td> </tr> <tr> <td>enumeration</td> <td>2009</td> </tr> <tr> <td>enumeration</td> <td>2010</td> </tr> <tr> <td>enumeration</td> <td>2011</td> </tr> <tr> <td>enumeration</td> <td>2012</td> </tr> <tr> <td>enumeration</td> <td>2013</td> </tr> <tr> <td>enumeration</td> <td>2014</td> </tr> <tr> <td>enumeration</td> <td>2015</td> </tr> </tbody> </table>	Kind	Value	pattern	[1-9]{1}[0-9]*	enumeration	2007	enumeration	2008	enumeration	2009	enumeration	2010	enumeration	2011	enumeration	2012	enumeration	2013	enumeration	2014	enumeration	2015
Kind	Value																						
pattern	[1-9]{1}[0-9]*																						
enumeration	2007																						
enumeration	2008																						
enumeration	2009																						
enumeration	2010																						
enumeration	2011																						
enumeration	2012																						
enumeration	2013																						
enumeration	2014																						
enumeration	2015																						

element Crediti_Imposta_Fondi_Pensione_Type/Reintegro

diagram	
---------	--

namespace	urn:www.agenziaentrate.gov.it:specificheTecniche:sco:p73	
type	p73:Reintegro Totale Parziale Type	
facets	Kind	Value
	pattern	[1-9]
	enumeration	1
	enumeration	2

element **Crediti_Imposta_Fondi_Pensione_Type/SommaReintegrata**

diagram		
namespace	urn:www.agenziaentrate.gov.it:specificheTecniche:sco:p73	
type	DatoNP Type	
facets	Kind	Value
	pattern	[1-9]{1}[0-9]*

element **Crediti_Imposta_Fondi_Pensione_Type/CreditoAnno**

diagram		
namespace	urn:www.agenziaentrate.gov.it:specificheTecniche:sco:p73	
type	DatoNP Type	
facets	Kind	Value
	pattern	[1-9]{1}[0-9]*

complexType **Crediti_Imposta_Reddito_Esteri_Type**

diagram		
namespace	urn:www.agenziaentrate.gov.it:specificheTecniche:sco:p73	
children	p73:StatoEstero p73:Anno p73:RedditoEstero p73:ImpostaEstera p73:RedditoComplessivo p73:Imposta_Lorda p73:ImpostaNetta p73:CreditoDichiarazioniPreced... p73:DiCuiStatoEstero	

	p73:ImpostaNetta p73:CreditoDichiarazioniPrecedenti p73:DiCuiStatoEstero
--	--

element Crediti_Imposta_Redditi_Esteri_Type/StatoEstero

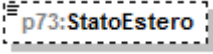
diagram	
namespace	urn:www.agenziaentrate.gov.it:specificheTecniche:sco:p73
type	DatoAN_Type
facets	Kind Value pattern (([0-9A-Z\-_]"){1}([0-9A-Z&:] '\- \., / ^\\(\)À È É Ì Ò Ù Û " \\ \\ +)*

element Crediti_Imposta_Redditi_Esteri_Type/Anno

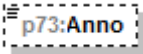
diagram	
namespace	urn:www.agenziaentrate.gov.it:specificheTecniche:sco:p73
type	restriction of DatoDA_Type
facets	Kind Value pattern (18 19 20)[0-9]{2}

element Crediti_Imposta_Redditi_Esteri_Type/RedditoEstero

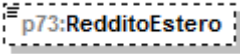
diagram	
namespace	urn:www.agenziaentrate.gov.it:specificheTecniche:sco:p73
type	DatoNP_Type
facets	Kind Value pattern [1-9]{1}[0-9]*

element Crediti_Imposta_Redditi_Esteri_Type/ImpostaEstera

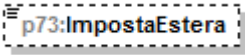
diagram	
namespace	urn:www.agenziaentrate.gov.it:specificheTecniche:sco:p73
type	DatoNP_Type
facets	Kind Value pattern [1-9]{1}[0-9]*

element Crediti_Imposta_Redditi_Esteri_Type/RedditoComplessivo

diagram	
namespace	urn:www.agenziaentrate.gov.it:specificheTecniche:sco:p73
type	DatoNP_Type

facets	Kind pattern	Value [1-9]{1}[0-9]*
--------	-----------------	-------------------------

element Crediti_Imposta_Redditi_Esteri_Type/Imposta_Lorda

diagram		
namespace	urn:www.agenziaentrate.gov.it:specificheTecniche:sco:p73	
type	DatoNP_Type	
facets	Kind pattern	Value [1-9]{1}[0-9]*

element Crediti_Imposta_Redditi_Esteri_Type/ImpostaNetta

diagram		
namespace	urn:www.agenziaentrate.gov.it:specificheTecniche:sco:p73	
type	DatoNP_Type	
facets	Kind pattern	Value [1-9]{1}[0-9]*

element Crediti_Imposta_Redditi_Esteri_Type/CreditoDichiarazioniPrecedenti

diagram		
namespace	urn:www.agenziaentrate.gov.it:specificheTecniche:sco:p73	
type	DatoNP_Type	
facets	Kind pattern	Value [1-9]{1}[0-9]*

element Crediti_Imposta_Redditi_Esteri_Type/DiCuiStatoEstero

diagram		
namespace	urn:www.agenziaentrate.gov.it:specificheTecniche:sco:p73	
type	DatoNP_Type	
facets	Kind pattern	Value [1-9]{1}[0-9]*

complexType Crediti_Imposta_Type

diagram		
---------	--	--

namespace	urn:www.agenziaentrate.gov.it:specificheTecniche:sco:p73
children	p73:PrimoModulo p73:Modulo

element **Crediti_Imposta_Type/PrimoModulo**

diagram	
namespace	urn:www.agenziaentrate.gov.it:specificheTecniche:sco:p73
type	p73:Primo_Modulo_Crediti_Imposta_Type
children	p73:CreditoImpostaFabbricati p73:CreditoImpostaFondiPensione p73:CreditoImpostaRedditiEsteri p73:CreditoPrimaCasaSismaAbruzzo p73:CreditoAltriSismaAbruzzo p73:CreditoIncrementoOccupazione p73:CreditoImpostaMediazioni p73:CreditoErogazioniCultura p73:CreditoNegoziazione

element **Crediti_Imposta_Type/Modulo**

diagram	
namespace	urn:www.agenziaentrate.gov.it:specificheTecniche:sco:p73

type	p73:Modulo_Crediti_Imposta_Type
children	p73:CreditoImpostaFondiPensione p73:CreditoImpostaRedditiEsteri p73:CreditoPrimaCasaSismaAbruzzo p73:CreditoAltriSismaAbruzzo p73:CreditoNegoziazione

complexType Credito_Erogazioni_Cultura_Type

diagram	
namespace	urn:www.agenziaentrate.gov.it:specificheTecniche:sco:p73
children	p73:SpesaAnno p73:ResiduoAnnoPrec p73:RataAnnoPrec

element Credito_Erogazioni_Cultura_Type/SpesaAnno

diagram					
namespace	urn:www.agenziaentrate.gov.it:specificheTecniche:sco:p73				
type	DatoNP_Type				
facets	<table border="1"> <tr> <td>Kind</td> <td>Value</td> </tr> <tr> <td>pattern</td> <td>[1-9]{1}[0-9]*</td> </tr> </table>	Kind	Value	pattern	[1-9]{1}[0-9]*
Kind	Value				
pattern	[1-9]{1}[0-9]*				

element Credito_Erogazioni_Cultura_Type/ResiduoAnnoPrec

diagram					
namespace	urn:www.agenziaentrate.gov.it:specificheTecniche:sco:p73				
type	DatoNP_Type				
facets	<table border="1"> <tr> <td>Kind</td> <td>Value</td> </tr> <tr> <td>pattern</td> <td>[1-9]{1}[0-9]*</td> </tr> </table>	Kind	Value	pattern	[1-9]{1}[0-9]*
Kind	Value				
pattern	[1-9]{1}[0-9]*				

element Credito_Erogazioni_Cultura_Type/RataAnnoPrec

diagram					
namespace	urn:www.agenziaentrate.gov.it:specificheTecniche:sco:p73				
type	DatoNP_Type				
facets	<table border="1"> <tr> <td>Kind</td> <td>Value</td> </tr> <tr> <td>pattern</td> <td>[1-9]{1}[0-9]*</td> </tr> </table>	Kind	Value	pattern	[1-9]{1}[0-9]*
Kind	Value				
pattern	[1-9]{1}[0-9]*				

complexType **Credito_Immibile_Sisma_Abruzzo_Type**

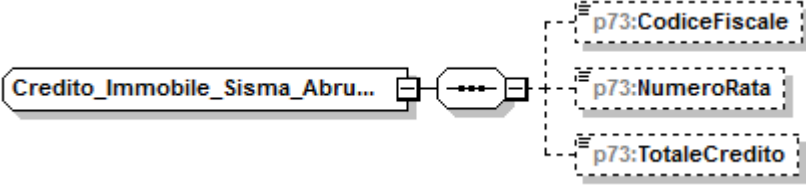
diagram	
namespace	urn:www.agenziaentrate.gov.it:specificheTecniche:sco:p73
children	p73:CodiceFiscale p73:NumeroRata p73:TotaleCredito

element **Credito_Immibile_Sisma_Abruzzo_Type/CodiceFiscale**

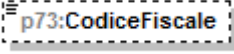
diagram					
namespace	urn:www.agenziaentrate.gov.it:specificheTecniche:sco:p73				
type	DatoCF_Type				
facets	<table border="1"> <thead> <tr> <th>Kind</th> <th>Value</th> </tr> </thead> <tbody> <tr> <td>pattern</td> <td>[0-9]{1}[A-Z]{6}[0-9LMNPQRSTU]{2}[A-Z]{1}[0-9LMNPQRSTU]{2}[A-Z]{1}[0-9LMNPQRSTU]{3}[A-Z]{1}</td> </tr> </tbody> </table>	Kind	Value	pattern	[0-9]{1}[A-Z]{6}[0-9LMNPQRSTU]{2}[A-Z]{1}[0-9LMNPQRSTU]{2}[A-Z]{1}[0-9LMNPQRSTU]{3}[A-Z]{1}
Kind	Value				
pattern	[0-9]{1}[A-Z]{6}[0-9LMNPQRSTU]{2}[A-Z]{1}[0-9LMNPQRSTU]{2}[A-Z]{1}[0-9LMNPQRSTU]{3}[A-Z]{1}				

element **Credito_Immibile_Sisma_Abruzzo_Type/NumeroRata**

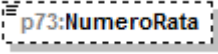
diagram																			
namespace	urn:www.agenziaentrate.gov.it:specificheTecniche:sco:p73																		
type	p73:Numero_RateDa1A7_Type																		
facets	<table border="1"> <thead> <tr> <th>Kind</th> <th>Value</th> </tr> </thead> <tbody> <tr> <td>pattern</td> <td>[1-9]</td> </tr> <tr> <td>enumeration</td> <td>1</td> </tr> <tr> <td>enumeration</td> <td>2</td> </tr> <tr> <td>enumeration</td> <td>3</td> </tr> <tr> <td>enumeration</td> <td>4</td> </tr> <tr> <td>enumeration</td> <td>5</td> </tr> <tr> <td>enumeration</td> <td>6</td> </tr> <tr> <td>enumeration</td> <td>7</td> </tr> </tbody> </table>	Kind	Value	pattern	[1-9]	enumeration	1	enumeration	2	enumeration	3	enumeration	4	enumeration	5	enumeration	6	enumeration	7
Kind	Value																		
pattern	[1-9]																		
enumeration	1																		
enumeration	2																		
enumeration	3																		
enumeration	4																		
enumeration	5																		
enumeration	6																		
enumeration	7																		

element **Credito_Immibile_Sisma_Abruzzo_Type/TotaleCredito**

diagram					
namespace	urn:www.agenziaentrate.gov.it:specificheTecniche:sco:p73				
type	DatoNP_Type				
facets	<table border="1"> <thead> <tr> <th>Kind</th> <th>Value</th> </tr> </thead> <tbody> <tr> <td>pattern</td> <td>[1-9]{1}[0-9]*</td> </tr> </tbody> </table>	Kind	Value	pattern	[1-9]{1}[0-9]*
Kind	Value				
pattern	[1-9]{1}[0-9]*				

complexType Credito_Negoziation_Type

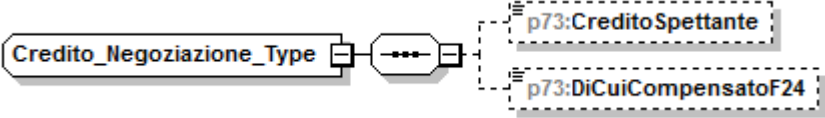
diagram	
namespace	urn:www.agenziaentrate.gov.it:specificheTecniche:sco:p73
children	p73:CreditoSpettante p73:DiCuiCompensatoF24

element Credito_Negoziation_Type/CreditoSpettante

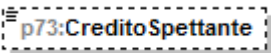
diagram	
namespace	urn:www.agenziaentrate.gov.it:specificheTecniche:sco:p73
type	DatoNP_Type
facets	Kind Value pattern [1-9]{1}[0-9]*

element Credito_Negoziation_Type/DiCuiCompensatoF24

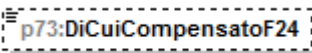
diagram	
namespace	urn:www.agenziaentrate.gov.it:specificheTecniche:sco:p73
type	DatoNP_Type
facets	Kind Value pattern [1-9]{1}[0-9]*

complexType Credito_Stato_Type

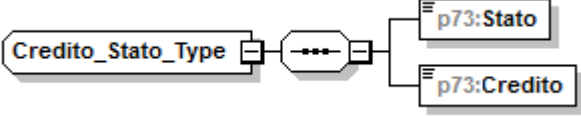
diagram	
namespace	urn:www.agenziaentrate.gov.it:specificheTecniche:sco:p73
children	p73:Stato p73:Credito

element Credito_Stato_Type/Stato

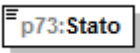
diagram	
namespace	urn:www.agenziaentrate.gov.it:specificheTecniche:sco:p73
type	DatoAN_Type
facets	Kind Value pattern (([0-9A-Z-] \"){1}([0-9A-Z&] " - \., / "^\\"(\\) À É È Ì Ò Ù Û " \\ / +)*

element Credito_Stato_Type/Credito

diagram					
namespace	urn:www.agenziaentrate.gov.it:specificheTecniche:sco:p73				
type	DatoNP_Type				
facets	<table border="1"> <tr> <th>Kind</th> <th>Value</th> </tr> <tr> <td>pattern</td> <td>[1-9]{1}[0-9]*</td> </tr> </table>	Kind	Value	pattern	[1-9]{1}[0-9]*
Kind	Value				
pattern	[1-9]{1}[0-9]*				

complexType Credito_Type

diagram	
namespace	urn:www.agenziaentrate.gov.it:specificheTecniche:sco:p73
children	p73:NonRimborsabile p73:Credito p73:CreditoF24 p73:CreditoRimborso

element Credito_Type/NonRimborsabile

diagram					
namespace	urn:www.agenziaentrate.gov.it:specificheTecniche:sco:p73				
type	DatoNP_Type				
facets	<table border="1"> <tr> <th>Kind</th> <th>Value</th> </tr> <tr> <td>pattern</td> <td>[1-9]{1}[0-9]*</td> </tr> </table>	Kind	Value	pattern	[1-9]{1}[0-9]*
Kind	Value				
pattern	[1-9]{1}[0-9]*				

element Credito_Type/Credito

diagram					
namespace	urn:www.agenziaentrate.gov.it:specificheTecniche:sco:p73				
type	DatoNP_Type				
facets	<table border="1"> <tr> <th>Kind</th> <th>Value</th> </tr> <tr> <td>pattern</td> <td>[1-9]{1}[0-9]*</td> </tr> </table>	Kind	Value	pattern	[1-9]{1}[0-9]*
Kind	Value				
pattern	[1-9]{1}[0-9]*				

element Credito_Type/CreditoF24

diagram	
---------	--

namespace	urn:www.agenziaentrate.gov.it:specificheTecniche:sco:p73
type	DatoNP_Type
facets	Kind Value pattern [1-9]{1}[0-9]*

element Credito_Type/CreditoRimborso

diagram	
namespace	urn:www.agenziaentrate.gov.it:specificheTecniche:sco:p73
type	DatoNP_Type
facets	Kind Value pattern [1-9]{1}[0-9]*

complexType Dati_730_Integrativo_Type

diagram	
namespace	urn:www.agenziaentrate.gov.it:specificheTecniche:sco:p73
children	p73:Rimborso p73:Credito

element Dati_730_Integrativo_Type/Rimborso

diagram	
namespace	urn:www.agenziaentrate.gov.it:specificheTecniche:sco:p73
type	p73:Elemento_Integrativo_Type
children	p73:lrpef p73:AddizionaleRegionalelrpef p73:AddComunalelrpef p73:CedolareSecca

element **Dati_730_Integrativo_Type/Credito**

diagram	
namespace	urn:www.agenziaentrate.gov.it:specificheTecniche:sco:p73
type	p73:Elemento_Integrativo_Type
children	p73:Irpef p73:AddizionaleRegionaleIrpef p73:AddComunaleIrpef p73:CedolareSecca

complexType **Dati_Altre_Detrazioni_Modulo_Type**

diagram	
namespace	urn:www.agenziaentrate.gov.it:specificheTecniche:sco:p73
children	p73:AltreDetrazioni

element **Dati_Altre_Detrazioni_Modulo_Type/AltreDetrazioni**

diagram	
namespace	urn:www.agenziaentrate.gov.it:specificheTecniche:sco:p73
type	p73:Altre_Detrazioni_Type
children	p73:Codice p73:Importo

complexType **Dati_Altre_Detrazioni_Type**

diagram	
namespace	urn:www.agenziaentrate.gov.it:specificheTecniche:sco:p73

children	p73:SpeseCaniGuida p73:AffittoTerreniAgricoliGiovani p73:AltreDetrazioni
----------	--

element Dati_Altre_Detrazioni_Type/SpeseCaniGuida

diagram	
namespace	urn:www.agenziaentrate.gov.it:specificheTecniche:sco:p73
type	DatoCB_Type
facets	Kind Value pattern [01]

element Dati_Altre_Detrazioni_Type/AffittoTerreniAgricoliGiovani

diagram	
namespace	urn:www.agenziaentrate.gov.it:specificheTecniche:sco:p73
type	DatoNP_Type
facets	Kind Value pattern [1-9]{1}[0-9]*

element Dati_Altre_Detrazioni_Type/AltreDetrazioni

diagram	
namespace	urn:www.agenziaentrate.gov.it:specificheTecniche:sco:p73
type	p73:Altre_Detrazioni_Type
children	p73:Codice p73:Importo

complexType Dati_Catastali_Recupero_Patrimonio_Edilizio_Type

diagram	
namespace	urn:www.agenziaentrate.gov.it:specificheTecniche:sco:p73
children	p73:NOrdImmabile p73:Condominio p73:DatiCatastali

element **Dati_Catastali_Recupero_Patrimonio_Edilizio_Type/NOrdImmobile**

diagram					
namespace	urn:www.agenziaentrate.gov.it:specificheTecniche:sco:p73				
type	DatoNP_Type				
facets	<table border="1"> <tr> <td>Kind</td> <td>Value</td> </tr> <tr> <td>pattern</td> <td>[1-9]{1}[0-9]*</td> </tr> </table>	Kind	Value	pattern	[1-9]{1}[0-9]*
Kind	Value				
pattern	[1-9]{1}[0-9]*				

element **Dati_Catastali_Recupero_Patrimonio_Edilizio_Type/Condominio**

diagram					
namespace	urn:www.agenziaentrate.gov.it:specificheTecniche:sco:p73				
type	DatoCB_Type				
facets	<table border="1"> <tr> <td>Kind</td> <td>Value</td> </tr> <tr> <td>pattern</td> <td>[01]</td> </tr> </table>	Kind	Value	pattern	[01]
Kind	Value				
pattern	[01]				

element **Dati_Catastali_Recupero_Patrimonio_Edilizio_Type/DatiCatastali**

diagram	
namespace	urn:www.agenziaentrate.gov.it:specificheTecniche:sco:p73
type	p73:Dati_Catastali_Type
children	p73:CodiceComune p73:TerreniUrbano p73:SezioneUrbanaComuneCatastale p73:Foglio p73:Particella p73:Subalterno

complexType Dati_Catastali_Type

diagram	
namespace	urn:www.agenziaentrate.gov.it:specificheTecniche:sco:p73
children	p73:CodiceComune p73:TerreniUrbano p73:SezioneUrbanaComuneCatastale p73:Foglio p73:Particella p73:Subalterno

element Dati_Catastali_Type/CodiceComune

diagram					
namespace	urn:www.agenziaentrate.gov.it:specificheTecniche:sco:p73				
type	DatoAN_Type				
facets	<table border="0"> <tr> <td>Kind</td> <td>Value</td> </tr> <tr> <td>pattern</td> <td>(([0-9A-Z-])&quot;){1}([0-9A-Z&amp;:] ' \"- \". , / ° \"^\"\\(\\) À É Ê Ï Ò Ù Û &quot; \\\" \\+)*</td> </tr> </table>	Kind	Value	pattern	(([0-9A-Z-])"){1}([0-9A-Z&:] ' \"- \". , / ° \"^\"\\(\\) À É Ê Ï Ò Ù Û " \\\" \\+)*
Kind	Value				
pattern	(([0-9A-Z-])"){1}([0-9A-Z&:] ' \"- \". , / ° \"^\"\\(\\) À É Ê Ï Ò Ù Û " \\\" \\+)*				

element Dati_Catastali_Type/TerreniUrbano

diagram									
namespace	urn:www.agenziaentrate.gov.it:specificheTecniche:sco:p73								
type	p73:Terreni_Urbano_Type								
facets	<table border="0"> <tr> <td>Kind</td> <td>Value</td> </tr> <tr> <td>pattern</td> <td>(([0-9A-Z-])&quot;){1}([0-9A-Z&amp;:] ' \"- \". , / ° \"^\"\\(\\) À É Ê Ï Ò Ù Û &quot; \\\" \\+)*</td> </tr> <tr> <td>enumeration</td> <td>T</td> </tr> <tr> <td>enumeration</td> <td>U</td> </tr> </table>	Kind	Value	pattern	(([0-9A-Z-])"){1}([0-9A-Z&:] ' \"- \". , / ° \"^\"\\(\\) À É Ê Ï Ò Ù Û " \\\" \\+)*	enumeration	T	enumeration	U
Kind	Value								
pattern	(([0-9A-Z-])"){1}([0-9A-Z&:] ' \"- \". , / ° \"^\"\\(\\) À É Ê Ï Ò Ù Û " \\\" \\+)*								
enumeration	T								
enumeration	U								

element Dati_Catastali_Type/SezioneUrbanaComuneCatastale

diagram					
namespace	urn:www.agenziaentrate.gov.it:specificheTecniche:sco:p73				
type	DatoAN_Type				
facets	<table border="0"> <tr> <td>Kind</td> <td>Value</td> </tr> <tr> <td>pattern</td> <td>(([0-9A-Z-])&quot;){1}([0-9A-Z&amp;:] ' \"- \". , / ° \"^\"\\(\\) À É Ê Ï Ò Ù Û &quot; \\\" \\+)*</td> </tr> </table>	Kind	Value	pattern	(([0-9A-Z-])"){1}([0-9A-Z&:] ' \"- \". , / ° \"^\"\\(\\) À É Ê Ï Ò Ù Û " \\\" \\+)*
Kind	Value				
pattern	(([0-9A-Z-])"){1}([0-9A-Z&:] ' \"- \". , / ° \"^\"\\(\\) À É Ê Ï Ò Ù Û " \\\" \\+)*				

element Dati_Catastali_Type/Foglio

diagram	
namespace	urn:www.agenziaentrate.gov.it:specificheTecniche:sco:p73
type	DatoAN_Type
facets	Kind Value pattern ([0-9A-Z\-_]"){1}([0-9A-Z&:] ' \"- \\. , / ^\\^\(\\) À È É Ì Ò Ù Û " \\ \\ \\+)*

element Dati_Catastali_Type/Particella

diagram	
namespace	urn:www.agenziaentrate.gov.it:specificheTecniche:sco:p73
children	p73:Numeratore p73:Denominatore

element Dati_Catastali_Type/Particella/Numeratore

diagram	
namespace	urn:www.agenziaentrate.gov.it:specificheTecniche:sco:p73
type	DatoAN_Type
facets	Kind Value pattern ([0-9A-Z\-_]"){1}([0-9A-Z&:] ' \"- \\. , / ^\\^\(\\) À È É Ì Ò Ù Û " \\ \\ \\+)*

element Dati_Catastali_Type/Particella/Denominatore

diagram	
namespace	urn:www.agenziaentrate.gov.it:specificheTecniche:sco:p73
type	DatoAN_Type
facets	Kind Value pattern ([0-9A-Z\-_]"){1}([0-9A-Z&:] ' \"- \\. , / ^\\^\(\\) À È É Ì Ò Ù Û " \\ \\ \\+)*

element Dati_Catastali_Type/Subalterno

diagram	
namespace	urn:www.agenziaentrate.gov.it:specificheTecniche:sco:p73
type	DatoAN_Type
facets	Kind Value pattern ([0-9A-Z\-_]"){1}([0-9A-Z&:] ' \"- \\. , / ^\\^\(\\) À È É Ì Ò Ù Û " \\ \\ \\+)*

complexType Dati_Coniuge_Type

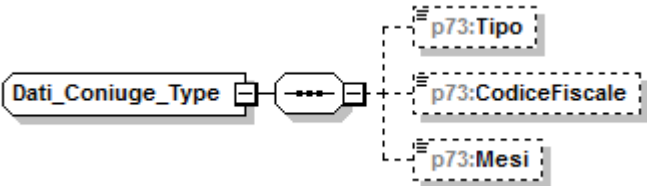
diagram	
namespace	urn:www.agenziaentrate.gov.it:specificheTecniche:sco:p73
children	p73:Tipo p73:CodiceFiscale p73:Mesi

element Dati_Coniuge_Type/Tipo

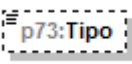
diagram					
namespace	urn:www.agenziaentrate.gov.it:specificheTecniche:sco:p73				
type	DatoCB_Type				
facets	<table border="1"> <thead> <tr> <th>Kind</th> <th>Value</th> </tr> </thead> <tbody> <tr> <td>pattern</td> <td>[01]</td> </tr> </tbody> </table>	Kind	Value	pattern	[01]
Kind	Value				
pattern	[01]				

element Dati_Coniuge_Type/CodiceFiscale

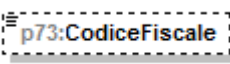
diagram					
namespace	urn:www.agenziaentrate.gov.it:specificheTecniche:sco:p73				
type	DatoCF_Type				
facets	<table border="1"> <thead> <tr> <th>Kind</th> <th>Value</th> </tr> </thead> <tbody> <tr> <td>pattern</td> <td>[0-9]{11}[A-Z]{6}[0-9LMNPQRSTU]{2}[A-Z]{1}[0-9LMNPQRSTU]{2}[A-Z]{1}[0-9LMNPQRSTU]{3}[A-Z]{1}</td> </tr> </tbody> </table>	Kind	Value	pattern	[0-9]{11}[A-Z]{6}[0-9LMNPQRSTU]{2}[A-Z]{1}[0-9LMNPQRSTU]{2}[A-Z]{1}[0-9LMNPQRSTU]{3}[A-Z]{1}
Kind	Value				
pattern	[0-9]{11}[A-Z]{6}[0-9LMNPQRSTU]{2}[A-Z]{1}[0-9LMNPQRSTU]{2}[A-Z]{1}[0-9LMNPQRSTU]{3}[A-Z]{1}				

element Dati_Coniuge_Type/Mesi

diagram																											
namespace	urn:www.agenziaentrate.gov.it:specificheTecniche:sco:p73																										
type	p73:Mesi_Type																										
facets	<table border="1"> <thead> <tr> <th>Kind</th> <th>Value</th> </tr> </thead> <tbody> <tr> <td>pattern</td> <td>[1-9]{1}[0-9]*</td> </tr> <tr> <td>enumeration</td> <td>1</td> </tr> <tr> <td>enumeration</td> <td>2</td> </tr> <tr> <td>enumeration</td> <td>3</td> </tr> <tr> <td>enumeration</td> <td>4</td> </tr> <tr> <td>enumeration</td> <td>5</td> </tr> <tr> <td>enumeration</td> <td>6</td> </tr> <tr> <td>enumeration</td> <td>7</td> </tr> <tr> <td>enumeration</td> <td>8</td> </tr> <tr> <td>enumeration</td> <td>9</td> </tr> <tr> <td>enumeration</td> <td>10</td> </tr> <tr> <td>enumeration</td> <td>11</td> </tr> </tbody> </table>	Kind	Value	pattern	[1-9]{1}[0-9]*	enumeration	1	enumeration	2	enumeration	3	enumeration	4	enumeration	5	enumeration	6	enumeration	7	enumeration	8	enumeration	9	enumeration	10	enumeration	11
Kind	Value																										
pattern	[1-9]{1}[0-9]*																										
enumeration	1																										
enumeration	2																										
enumeration	3																										
enumeration	4																										
enumeration	5																										
enumeration	6																										
enumeration	7																										
enumeration	8																										
enumeration	9																										
enumeration	10																										
enumeration	11																										

	enumeration 12
--	----------------

complexType Dati_Contabili_Type

diagram	
namespace	urn:www.agenziaentrate.gov.it:specificheTecniche:sco:p73
children	p73:Familiari p73:QuadroA p73:QuadroB p73:QuadroC p73:QuadroD p73:QuadroE p73:QuadroF p73:QuadroG p73:ProspettoLiquidazione

element Dati_Contabili_Type/Familiari

diagram	
namespace	urn:www.agenziaentrate.gov.it:specificheTecniche:sco:p73
type	p73:Familiari_Type
children	p73:PrimoModulo p73:Modulo

element **Dati_Contabili_Type/QuadroA**

diagram	
namespace	urn:www.agenziaentrate.gov.it:specificheTecniche:sco:p73
type	p73:Redditi_Terreni_Type
children	p73:Modulo

element **Dati_Contabili_Type/QuadroB**

diagram	
namespace	urn:www.agenziaentrate.gov.it:specificheTecniche:sco:p73
type	p73:Redditi_Fabbricati_Type
children	p73:Modulo

element **Dati_Contabili_Type/QuadroC**

diagram	
namespace	urn:www.agenziaentrate.gov.it:specificheTecniche:sco:p73
type	p73:Redditi_Lavoro_Dip_Type
children	p73:PrimoModulo p73:Modulo

element **Dati_Contabili_Type/QuadroD**

diagram	
---------	--

namespace	urn:www.agenziaentrate.gov.it:specificheTecniche:sco:p73
type	extension of p73:Altri_Redditi_Type
children	p73:Modulo

element Dati_Contabili_Type/QuadroE

diagram	
namespace	urn:www.agenziaentrate.gov.it:specificheTecniche:sco:p73
type	p73:Oneri_Type
children	p73:PrimoModulo p73:Modulo

element Dati_Contabili_Type/QuadroF

diagram	
namespace	urn:www.agenziaentrate.gov.it:specificheTecniche:sco:p73
type	p73:Acconti_Ritenute_Type
children	p73:PrimoModulo p73:Modulo

element Dati_Contabili_Type/QuadroG

diagram	
namespace	urn:www.agenziaentrate.gov.it:specificheTecniche:sco:p73
type	p73:Crediti_Imposta_Type
children	p73:PrimoModulo p73:Modulo

element Dati_Contabili_Type/ProspettoLiquidazione

diagram	
namespace	urn:www.agenziaentrate.gov.it:specificheTecniche:sco:p73
type	p73:Prospetto Liquidazione Type
children	p73:PrimoModulo p73:Modulo

complexType Dati_Contratto_Type

diagram	
namespace	urn:www.agenziaentrate.gov.it:specificheTecniche:sco:p73
children	p73:DataRegContratto p73:SerieContratto p73:NumeroContratto p73:Sottonumero p73:CodiceUfficio

element Dati_Contratto_Type/DataRegContratto

diagram					
namespace	urn:www.agenziaentrate.gov.it:specificheTecniche:sco:p73				
type	DatoDT_Type				
facets	<table border="0"> <tr> <td>Kind</td> <td>Value</td> </tr> <tr> <td>pattern</td> <td>((([0-9]{12} [12][0-9]{3}[01])(0[13578][10]12)\d{4}))((([0-9]{12} [12][0-9]{3}[01]30)(0[469][11]\d{4}))((([0-9]{12} [12][0-9]{3}[01]8)[02]\d{4}))((29)(02)([02468][048]00))((29)(02)([13579][26]00))((29)(02)([0-9][0-9][0]48))((29)(02)([0-9][0-9][2468][048]))((29)(02)([0-9][0-9][13579][26]))))</td> </tr> </table>	Kind	Value	pattern	((([0-9]{12} [12][0-9]{3}[01])(0[13578][10]12)\d{4}))((([0-9]{12} [12][0-9]{3}[01]30)(0[469][11]\d{4}))((([0-9]{12} [12][0-9]{3}[01]8)[02]\d{4}))((29)(02)([02468][048]00))((29)(02)([13579][26]00))((29)(02)([0-9][0-9][0]48))((29)(02)([0-9][0-9][2468][048]))((29)(02)([0-9][0-9][13579][26]))))
Kind	Value				
pattern	((([0-9]{12} [12][0-9]{3}[01])(0[13578][10]12)\d{4}))((([0-9]{12} [12][0-9]{3}[01]30)(0[469][11]\d{4}))((([0-9]{12} [12][0-9]{3}[01]8)[02]\d{4}))((29)(02)([02468][048]00))((29)(02)([13579][26]00))((29)(02)([0-9][0-9][0]48))((29)(02)([0-9][0-9][2468][048]))((29)(02)([0-9][0-9][13579][26]))))				

element Dati_Contratto_Type/SerieContratto

diagram	
namespace	urn:www.agenziaentrate.gov.it:specificheTecniche:sco:p73

type	p73:Serie Registrazione Contratto Type	
facets	Kind	Value
	pattern	(([0-9A-Z\-\]]"){1}([0-9A-Z&]] \-\- . \ °\^\(\ \) À É È Ì Ò Ù Û " \ \ \ +)*
	enumeration	3
	enumeration	3A
	enumeration	3B
	enumeration	3P
	enumeration	3T

element Dati_Contratto_Type/NumeroContratto

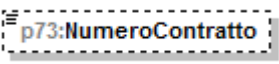
diagram		
namespace	urn:www.agenziaentrate.gov.it:specificheTecniche:sco:p73	
type	DatoAN Type	
facets	Kind	Value
	pattern	(([0-9A-Z\-\]]"){1}([0-9A-Z&]] \-\- . \ °\^\(\ \) À É È Ì Ò Ù Û " \ \ \ +)*

element Dati_Contratto_Type/Sottonumero

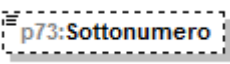
diagram		
namespace	urn:www.agenziaentrate.gov.it:specificheTecniche:sco:p73	
type	DatoAN Type	
facets	Kind	Value
	pattern	(([0-9A-Z\-\]]"){1}([0-9A-Z&]] \-\- . \ °\^\(\ \) À É È Ì Ò Ù Û " \ \ \ +)*

element Dati_Contratto_Type/CodiceUfficio

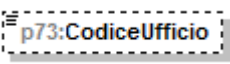
diagram		
namespace	urn:www.agenziaentrate.gov.it:specificheTecniche:sco:p73	
type	restriction of DatoAN Type	
facets	Kind	Value
	pattern	(([0-9A-Z\-\]]"){1}([0-9A-Z&]] \-\- . \ °\^\(\ \) À É È Ì Ò Ù Û " \ \ \ +)*

complexType **Dati_Familiare_Type**

diagram	
namespace	urn:www.agenziaentrate.gov.it:specificheTecniche:sco:p73
children	p73:CodiceFiscale p73:Mesi p73:MesiMinore p73:PercDetraz p73:PercDetrazCon p73:Affidamento

element **Dati_Familiare_Type/CodiceFiscale**

diagram					
namespace	urn:www.agenziaentrate.gov.it:specificheTecniche:sco:p73				
type	DatoCF_Type				
facets	<table border="0"> <tr> <td>Kind</td> <td>Value</td> </tr> <tr> <td>pattern</td> <td>[0-9]{11}[A-Z]{6}0-9LMNPQRSTUUV{2}[A-Z]{1}0-9LMNPQRSTUUV{2}[A-Z]{1}0-9LMNPQRSTUUV{3}[A-Z]{1}</td> </tr> </table>	Kind	Value	pattern	[0-9]{11}[A-Z]{6}0-9LMNPQRSTUUV{2}[A-Z]{1}0-9LMNPQRSTUUV{2}[A-Z]{1}0-9LMNPQRSTUUV{3}[A-Z]{1}
Kind	Value				
pattern	[0-9]{11}[A-Z]{6}0-9LMNPQRSTUUV{2}[A-Z]{1}0-9LMNPQRSTUUV{2}[A-Z]{1}0-9LMNPQRSTUUV{3}[A-Z]{1}				

element **Dati_Familiare_Type/Mesi**

diagram					
namespace	urn:www.agenziaentrate.gov.it:specificheTecniche:sco:p73				
type	DatoNP_Type				
facets	<table border="0"> <tr> <td>Kind</td> <td>Value</td> </tr> <tr> <td>pattern</td> <td>[1-9]{1}[0-9]*</td> </tr> </table>	Kind	Value	pattern	[1-9]{1}[0-9]*
Kind	Value				
pattern	[1-9]{1}[0-9]*				

element **Dati_Familiare_Type/MesiMinore**

diagram					
namespace	urn:www.agenziaentrate.gov.it:specificheTecniche:sco:p73				
type	DatoNP_Type				
facets	<table border="0"> <tr> <td>Kind</td> <td>Value</td> </tr> <tr> <td>pattern</td> <td>[1-9]{1}[0-9]*</td> </tr> </table>	Kind	Value	pattern	[1-9]{1}[0-9]*
Kind	Value				
pattern	[1-9]{1}[0-9]*				

element Dati_Familiare_Type/PercDetraz

diagram					
namespace	urn:www.agenziaentrate.gov.it:specificheTecniche:sco:p73				
type	DatoPC_Type				
facets	<table border="1"> <tr> <td>Kind</td> <td>Value</td> </tr> <tr> <td>pattern</td> <td>[0-9]?[0-9](, d{1,3})? 100,0{1,3}?</td> </tr> </table>	Kind	Value	pattern	[0-9]?[0-9](, d{1,3})? 100,0{1,3}?
Kind	Value				
pattern	[0-9]?[0-9](, d{1,3})? 100,0{1,3}?				

element Dati_Familiare_Type/PercDetrazCon

diagram					
namespace	urn:www.agenziaentrate.gov.it:specificheTecniche:sco:p73				
type	DatoAN_Type				
facets	<table border="1"> <tr> <td>Kind</td> <td>Value</td> </tr> <tr> <td>pattern</td> <td>(([0-9A-Z-] &quot;){1}([0-9A-Z&amp;] ' \"- \\. / ° \\\"(\\) À É È Ì Ò Ù Û &quot; \\\" \\+)*</td> </tr> </table>	Kind	Value	pattern	(([0-9A-Z-] "){1}([0-9A-Z&] ' \"- \\. / ° \\\"(\\) À É È Ì Ò Ù Û " \\\" \\+)*
Kind	Value				
pattern	(([0-9A-Z-] "){1}([0-9A-Z&] ' \"- \\. / ° \\\"(\\) À É È Ì Ò Ù Û " \\\" \\+)*				

element Dati_Familiare_Type/Affidamento

diagram					
namespace	urn:www.agenziaentrate.gov.it:specificheTecniche:sco:p73				
type	DatoCB_Type				
facets	<table border="1"> <tr> <td>Kind</td> <td>Value</td> </tr> <tr> <td>pattern</td> <td>[01]</td> </tr> </table>	Kind	Value	pattern	[01]
Kind	Value				
pattern	[01]				

complexType Dati_Nascita_PF_Type

diagram	
namespace	urn:www.agenziaentrate.gov.it:specificheTecniche:sco:p73
children	p73:Sesso p73:DataNascita p73:ComuneNascita p73:ProvinciaNascita

element Dati_Nascita_PF_Type/Sesso

diagram	
namespace	urn:www.agenziaentrate.gov.it:specificheTecniche:sco:p73

type	Sesso Type	
facets	Kind	Value
	pattern	(([0-9A-Z-])"){1}([0-9A-Z&:] \\-\\. / ^\\^\\(\\)À È É Ì Ò Ù Ü " \\ \\ \\+)*
	enumeration	M
	enumeration	F

element **Dati_Nascita_PF_Type/DataNascita**

diagram		
namespace	urn:www.agenziaentrate.gov.it:specificheTecniche:sco:p73	
type	DatoDT Type	
facets	Kind	Value
	pattern	((([0-9]{1-9} [12][0-9]{3} 01))(0[13578] 10 12)(\\d{4}))((([0-9]{1-9} [12][0-9]{30}(0[469] 11)(\\d{4})) ((0[1-9] 1[0-9] 2[0-8])(02)(\\d{4})) ((29)(02)([02468][048]00)) ((29)(02)([13579][26]00)) ((29)(02)([0-9][0-9][48])) ((29)(02)([0-9][0-9][2468][048])) ((29)(02)([0-9][0-9][13579][26]))))

element **Dati_Nascita_PF_Type/ComuneNascita**

diagram		
namespace	urn:www.agenziaentrate.gov.it:specificheTecniche:sco:p73	
type	DatoAN Type	
facets	Kind	Value
	pattern	(([0-9A-Z-])"){1}([0-9A-Z&:] \\-\\. / ^\\^\\(\\)À È É Ì Ò Ù Ü " \\ \\ \\+)*

element **Dati_Nascita_PF_Type/ProvinciaNascita**

diagram		
namespace	urn:www.agenziaentrate.gov.it:specificheTecniche:sco:p73	
type	PN Type	

complexType **Dati_Primo_Figlio_Type**

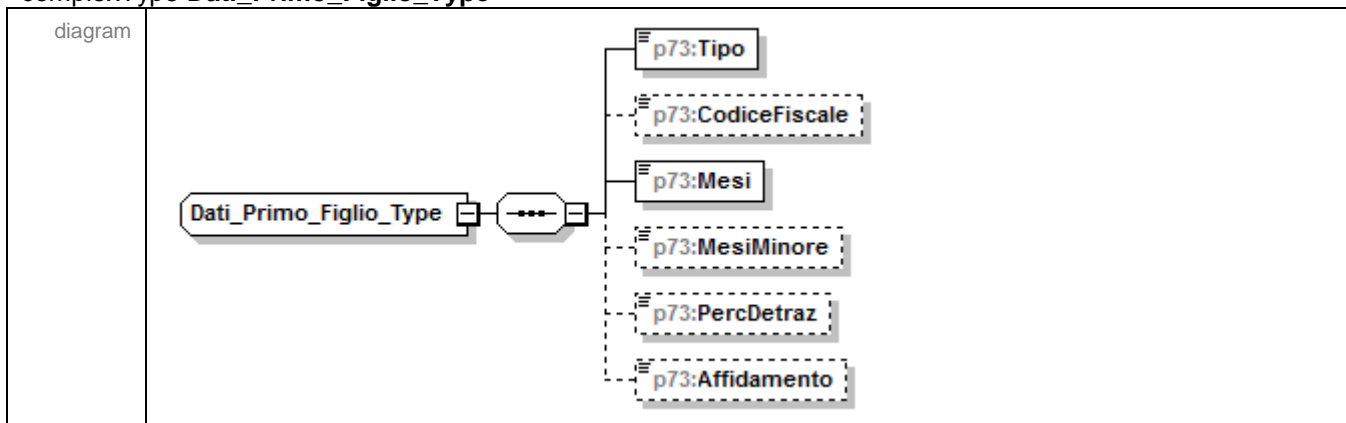

namespace	urn:www.agenziaentrate.gov.it:specificheTecniche:sco:p73
children	p73:Tipo p73:CodiceFiscale p73:Mesi p73:MesiMinore p73:PercDetraz p73:Affidamento

element Dati_Primo_Figlio_Type/Tipo

diagram									
namespace	urn:www.agenziaentrate.gov.it:specificheTecniche:sco:p73								
type	restriction of DatoAN_Type								
facets	<table border="0"> <tr> <td>Kind</td> <td>Value</td> </tr> <tr> <td>pattern</td> <td>(([0-9A-Z-])&quot;){1}([0-9A-Z&amp;:] ' - \., / ° °\^ \(\) À É È Ì Ò Ù Û &quot; \N +)*</td> </tr> <tr> <td>enumeration</td> <td>F</td> </tr> <tr> <td>enumeration</td> <td>D</td> </tr> </table>	Kind	Value	pattern	(([0-9A-Z-])"){1}([0-9A-Z&:] ' - \., / ° °\^ \(\) À É È Ì Ò Ù Û " \N +)*	enumeration	F	enumeration	D
Kind	Value								
pattern	(([0-9A-Z-])"){1}([0-9A-Z&:] ' - \., / ° °\^ \(\) À É È Ì Ò Ù Û " \N +)*								
enumeration	F								
enumeration	D								

element Dati_Primo_Figlio_Type/CodiceFiscale

diagram					
namespace	urn:www.agenziaentrate.gov.it:specificheTecniche:sco:p73				
type	DatoCF_Type				
facets	<table border="0"> <tr> <td>Kind</td> <td>Value</td> </tr> <tr> <td>pattern</td> <td>[0-9]{11}[A-Z]{6}[0-9LMNPQRSTUVWXYZ]{2}[A-Z]{1}[0-9LMNPQRSTUVWXYZ]{2}[A-Z]{1}[0-9LMNPQRSTUVWXYZ]{3}[A-Z]{1}</td> </tr> </table>	Kind	Value	pattern	[0-9]{11}[A-Z]{6}[0-9LMNPQRSTUVWXYZ]{2}[A-Z]{1}[0-9LMNPQRSTUVWXYZ]{2}[A-Z]{1}[0-9LMNPQRSTUVWXYZ]{3}[A-Z]{1}
Kind	Value				
pattern	[0-9]{11}[A-Z]{6}[0-9LMNPQRSTUVWXYZ]{2}[A-Z]{1}[0-9LMNPQRSTUVWXYZ]{2}[A-Z]{1}[0-9LMNPQRSTUVWXYZ]{3}[A-Z]{1}				

element Dati_Primo_Figlio_Type/Mesi

diagram																													
namespace	urn:www.agenziaentrate.gov.it:specificheTecniche:sco:p73																												
type	p73:Mesi_Type																												
facets	<table border="0"> <tr> <td>Kind</td> <td>Value</td> </tr> <tr> <td>pattern</td> <td>[1-9]{1}[0-9]*</td> </tr> <tr> <td>enumeration</td> <td>1</td> </tr> <tr> <td>enumeration</td> <td>2</td> </tr> <tr> <td>enumeration</td> <td>3</td> </tr> <tr> <td>enumeration</td> <td>4</td> </tr> <tr> <td>enumeration</td> <td>5</td> </tr> <tr> <td>enumeration</td> <td>6</td> </tr> <tr> <td>enumeration</td> <td>7</td> </tr> <tr> <td>enumeration</td> <td>8</td> </tr> <tr> <td>enumeration</td> <td>9</td> </tr> <tr> <td>enumeration</td> <td>10</td> </tr> <tr> <td>enumeration</td> <td>11</td> </tr> <tr> <td>enumeration</td> <td>12</td> </tr> </table>	Kind	Value	pattern	[1-9]{1}[0-9]*	enumeration	1	enumeration	2	enumeration	3	enumeration	4	enumeration	5	enumeration	6	enumeration	7	enumeration	8	enumeration	9	enumeration	10	enumeration	11	enumeration	12
Kind	Value																												
pattern	[1-9]{1}[0-9]*																												
enumeration	1																												
enumeration	2																												
enumeration	3																												
enumeration	4																												
enumeration	5																												
enumeration	6																												
enumeration	7																												
enumeration	8																												
enumeration	9																												
enumeration	10																												
enumeration	11																												
enumeration	12																												

element Dati_Primo_Figlio_Type/MesiMinore

diagram	
namespace	urn:www.agenziaentrate.gov.it:specificheTecniche:sco:p73

type	p73:Mesi_Type	
facets	Kind	Value
	pattern	[1-9]{1}[0-9]*
	enumeration	1
	enumeration	2
	enumeration	3
	enumeration	4
	enumeration	5
	enumeration	6
	enumeration	7
	enumeration	8
	enumeration	9
	enumeration	10
	enumeration	11
	enumeration	12

element Dati_Primo_Figlio_Type/PercDetraz

diagram		
namespace	urn:www.agenziaentrate.gov.it:specificheTecniche:sco:p73	
type	DatoPC_Type	
facets	Kind	Value
	pattern	[0-9]?[0-9](, d(1,3))?. 100(,0(1,3))?

element Dati_Primo_Figlio_Type/Affidamento

diagram		
namespace	urn:www.agenziaentrate.gov.it:specificheTecniche:sco:p73	
type	DatoCB_Type	
facets	Kind	Value
	pattern	[01]

complexType Dati_Registrazione_Accatamento_Recupero_Patrimonio_Edilizio_Type

diagram		
namespace	urn:www.agenziaentrate.gov.it:specificheTecniche:sco:p73	
children	p73:NOrdImmobilabile p73:Condominio p73:EstremiRegistrazioneContratto p73:DomandaAccatamento	

element **Dati_Registrazione_Accatastamento_Recupero_Patrimonio_Edilizio_Type/NOrdImmobile**

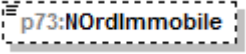
diagram					
namespace	urn:www.agenziaentrate.gov.it:specificheTecniche:sco:p73				
type	DatoNP_Type				
facets	<table border="1"> <tr> <td>Kind</td> <td>Value</td> </tr> <tr> <td>pattern</td> <td>[1-9]{1}[0-9]*</td> </tr> </table>	Kind	Value	pattern	[1-9]{1}[0-9]*
Kind	Value				
pattern	[1-9]{1}[0-9]*				

element **Dati_Registrazione_Accatastamento_Recupero_Patrimonio_Edilizio_Type/Condominio**

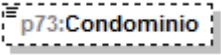
diagram					
namespace	urn:www.agenziaentrate.gov.it:specificheTecniche:sco:p73				
type	DatoCB_Type				
facets	<table border="1"> <tr> <td>Kind</td> <td>Value</td> </tr> <tr> <td>pattern</td> <td>[01]</td> </tr> </table>	Kind	Value	pattern	[01]
Kind	Value				
pattern	[01]				

element **Dati_Registrazione_Accatastamento_Recupero_Patrimonio_Edilizio_Type/EstremiRegistrazioneContratto**

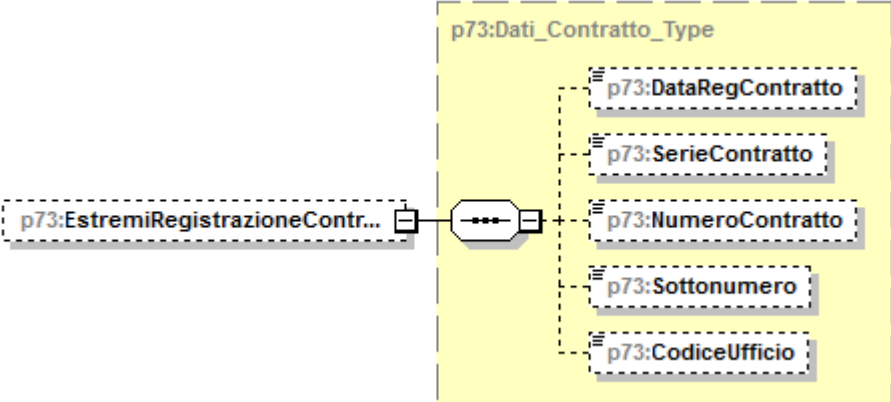
diagram	
namespace	urn:www.agenziaentrate.gov.it:specificheTecniche:sco:p73
type	p73:Dati_Contratto_Type
children	p73:DataRegContratto p73:SerieContratto p73:NumeroContratto p73:Sottonumero p73:CodiceUfficio

element

Dati_Registrazione_Accatastamento_Recupero_Patrimonio_Edilizio_Type/DomandaAccatastamento

diagram	
namespace	urn:www.agenziaentrate.gov.it:specificheTecniche:sco:p73
type	p73:Domanda_Accatastamento_Type
children	p73:Data p73:Numero p73:ProvinciaUfficio

complexType **Debito_Type**

diagram	
namespace	urn:www.agenziaentrate.gov.it:specificheTecniche:sco:p73
children	p73:NonVersare p73:ImportoDaTrattenere

element **Debito_Type/NonVersare**

diagram					
namespace	urn:www.agenziaentrate.gov.it:specificheTecniche:sco:p73				
type	DatoNP_Type				
facets	<table border="1"> <tr> <td>Kind</td> <td>Value</td> </tr> <tr> <td>pattern</td> <td>[1-9]{1}[0-9]*</td> </tr> </table>	Kind	Value	pattern	[1-9]{1}[0-9]*
Kind	Value				
pattern	[1-9]{1}[0-9]*				

element **Debito_Type/ImportoDaTrattenere**

diagram					
namespace	urn:www.agenziaentrate.gov.it:specificheTecniche:sco:p73				
type	DatoNP_Type				
facets	<table border="1"> <tr> <td>Kind</td> <td>Value</td> </tr> <tr> <td>pattern</td> <td>[1-9]{1}[0-9]*</td> </tr> </table>	Kind	Value	pattern	[1-9]{1}[0-9]*
Kind	Value				
pattern	[1-9]{1}[0-9]*				

complexType Deduzioni_Modulo_Type

diagram	
namespace	urn:www.agenziaentrate.gov.it:specificheTecniche:sco:p73
children	p73:AssegnoConiuge p73:AltriOneri p73:AcquistoCostruzioneAbitLocazione

element Deduzioni_Modulo_Type/AssegnoConiuge

diagram	
namespace	urn:www.agenziaentrate.gov.it:specificheTecniche:sco:p73
type	p73:Assegno_Coniuge_Type
children	p73:CodiceFiscale p73:Importo

element Deduzioni_Modulo_Type/AltriOneri

diagram	
namespace	urn:www.agenziaentrate.gov.it:specificheTecniche:sco:p73
type	p73:Altri_Oneri_Type
children	p73:Codice p73:Importo

element **Deduzioni_Modulo_Type/AcquistoCostruzioneAbitLocazione**

<p>diagram</p>	
<p>namespace</p>	<p>urn:www.agenziaentrate.gov.it:specificheTecniche:sco:p73</p>
<p>type</p>	<p>p73:Acquisto_Costruzione_Abit_Locazione</p>
<p>children</p>	<p>p73:DataStipula p73:Spesa p73:InteressiMutuo</p>

complexType **Deduzioni_Type**

<p>diagram</p>	
<p>namespace</p>	<p>urn:www.agenziaentrate.gov.it:specificheTecniche:sco:p73</p>
<p>children</p>	<p>p73:ContributiPrevAss p73:AssegnoConiuge p73:ContributiColf p73:ErogazioniIstituzioniReligiose p73:SpesePortatoriHandicap p73:AltriOneri p73:DeducibilitaOrdinaria p73:LavoratoriPrimaOccupazione p73:FondiInSquilibrioFinanziario p73:FamiliariACarico p73:FondoPensioneDipendentiPubblici p73:AcquistoCostruzioneAbitLocazione p73:RestituzioneSomme</p>

element Deduzioni_Type/ContributiPrevAss

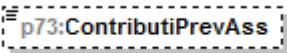
diagram					
namespace	urn:www.agenziaentrate.gov.it:specificheTecniche:sco:p73				
type	DatoNP_Type				
facets	<table border="1"> <tr> <th>Kind</th> <th>Value</th> </tr> <tr> <td>pattern</td> <td>[1-9]{1}[0-9]*</td> </tr> </table>	Kind	Value	pattern	[1-9]{1}[0-9]*
Kind	Value				
pattern	[1-9]{1}[0-9]*				

element Deduzioni_Type/AssegnoConiuge

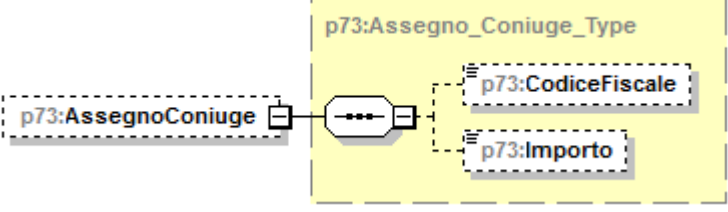
diagram	
namespace	urn:www.agenziaentrate.gov.it:specificheTecniche:sco:p73
type	p73:Assegno_Coniuge_Type
children	p73:CodiceFiscale p73:Importo

element Deduzioni_Type/ContributiColf

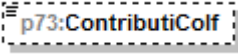
diagram					
namespace	urn:www.agenziaentrate.gov.it:specificheTecniche:sco:p73				
type	DatoNP_Type				
facets	<table border="1"> <tr> <th>Kind</th> <th>Value</th> </tr> <tr> <td>pattern</td> <td>[1-9]{1}[0-9]*</td> </tr> </table>	Kind	Value	pattern	[1-9]{1}[0-9]*
Kind	Value				
pattern	[1-9]{1}[0-9]*				

element Deduzioni_Type/ErogazioniIstituzioniReligiose

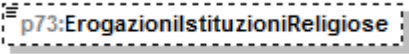
diagram					
namespace	urn:www.agenziaentrate.gov.it:specificheTecniche:sco:p73				
type	DatoNP_Type				
facets	<table border="1"> <tr> <th>Kind</th> <th>Value</th> </tr> <tr> <td>pattern</td> <td>[1-9]{1}[0-9]*</td> </tr> </table>	Kind	Value	pattern	[1-9]{1}[0-9]*
Kind	Value				
pattern	[1-9]{1}[0-9]*				

element Deduzioni_Type/SpesePortatoriHandicap

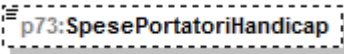
diagram	
---------	---

namespace	urn:www.agenziaentrate.gov.it:specificheTecniche:sco:p73
type	DatoNP_Type
facets	Kind Value pattern [1-9]{1}[0-9]*

element **Deduzioni_Type/AltriOneri**

diagram	
namespace	urn:www.agenziaentrate.gov.it:specificheTecniche:sco:p73
type	p73:Altri Oneri Type
children	p73:Codice p73:Importo

element **Deduzioni_Type/DeducibilitaOrdinaria**

diagram	
namespace	urn:www.agenziaentrate.gov.it:specificheTecniche:sco:p73
type	p73:Contributi Previdenza Complementare Type
children	p73:EsclusiDalSostituto p73:NonEsclusiDalSostituto

element **Deduzioni_Type/LavoratoriPrimaOccupazione**

diagram	
namespace	urn:www.agenziaentrate.gov.it:specificheTecniche:sco:p73
type	p73:Contributi Previdenza Complementare Type
children	p73:EsclusiDalSostituto p73:NonEsclusiDalSostituto

element **Deduzioni_Type/FondiInSquilibrioFinanziario**

diagram	<p>The diagram shows a class <code>p73:FondiInSquilibrioFinanziario</code> (dashed box) associated with a class <code>p73:Contributi_Previdenza_Complementare_Type</code> (solid box). The association is represented by a line with an open arrowhead pointing to the <code>p73:Contributi_Previdenza_Complementare_Type</code> class. Inside this class, there are two subclasses: <code>p73:EsclusiDalSostituto</code> and <code>p73:NonEsclusiDalSostituto</code>, both shown in dashed boxes.</p>
namespace	urn:www.agenziaentrate.gov.it:specificheTecniche:sco:p73
type	p73:Contributi_Previdenza_Complementare_Type
children	p73:EsclusiDalSostituto p73:NonEsclusiDalSostituto

element **Deduzioni_Type/FamiliariACarico**

diagram	<p>The diagram shows a class <code>p73:FamiliariACarico</code> (dashed box) associated with a class <code>p73:Contributi_Previdenza_Complementare_Type</code> (solid box). The association is represented by a line with an open arrowhead pointing to the <code>p73:Contributi_Previdenza_Complementare_Type</code> class. Inside this class, there are two subclasses: <code>p73:EsclusiDalSostituto</code> and <code>p73:NonEsclusiDalSostituto</code>, both shown in dashed boxes.</p>
namespace	urn:www.agenziaentrate.gov.it:specificheTecniche:sco:p73
type	p73:Contributi_Previdenza_Complementare_Type
children	p73:EsclusiDalSostituto p73:NonEsclusiDalSostituto

element **Deduzioni_Type/FondoPensioneDipendentiPubblici**

diagram	<p>The diagram shows a class <code>p73:FondoPensioneDipendenti...</code> (dashed box) associated with a class <code>p73:Fondo_Pensione_Dipendenti_Pubblici_Type</code> (solid box). The association is represented by a line with an open arrowhead pointing to the <code>p73:Fondo_Pensione_Dipendenti_Pubblici_Type</code> class. Inside this class, there are two subclasses: <code>p73:Contributi</code> and <code>p73:QuotaTFR</code>, both shown in dashed boxes.</p>
namespace	urn:www.agenziaentrate.gov.it:specificheTecniche:sco:p73
type	p73:Fondo_Pensione_Dipendenti_Pubblici_Type
children	p73:Contributi p73:QuotaTFR

element **Deduzioni_Type/AcquistoCostruzioneAbitLocazione**

diagram	
namespace	urn:www.agenziaentrate.gov.it:specificheTecniche:sco:p73
type	p73:Acquisto_Costruzione_Abit_Locazione
children	p73:DataStipula p73:Spesa p73:InteressiMutuo

element **Deduzioni_Type/RestituzioneSomme**

diagram	
namespace	urn:www.agenziaentrate.gov.it:specificheTecniche:sco:p73
type	p73:Restituzione_Somme_Type
children	p73:SommeRestituite p73:ResiduoPrecedenteDic

complexType **Detrazione_Crediti_Type**

<p>diagram</p>	
<p>namespace</p>	<p>urn:www.agenziaentrate.gov.it:specificheTecniche:sco:p73</p>
<p>children</p>	<p>p73:DetrazioneConiuge p73:DetrazioneFigli p73:UlterioreDetrazioneFigli p73:DetrazioneFamiliari p73:DetrazioneLavDip p73:DetrazionePens p73:DetrazioneAltriRedditi p73:DetrazioneOneri p73:DetrazioneRistrutturazione p73:DetrazioniArredolmmobili p73:DetrazioneRisparmioEnergetico p73:DetrazioneLocEAgricoliGiovani p73:AltreDetrazioni p73:CreditoPrimaCasa p73:CreditoOccupazione p73:CreditoFondiPensione p73:CreditoMediazioni p73:CreditoNegoziazione p73:TotaleDetrazioniCrediti</p>

element **Detrazione_Crediti_Type/DetrazioneConiuge**

<p>diagram</p>	
----------------	--

namespace	urn:www.agenziaentrate.gov.it:specificheTecniche:sco:p73
type	DatoNP_Type
facets	Kind Value pattern [1-9]{1}[0-9]*

element Detrazione_Crediti_Type/DetrazioneFigli

diagram	
namespace	urn:www.agenziaentrate.gov.it:specificheTecniche:sco:p73
type	DatoNP_Type
facets	Kind Value pattern [1-9]{1}[0-9]*

element Detrazione_Crediti_Type/UlterioreDetrazioneFigli

diagram	
namespace	urn:www.agenziaentrate.gov.it:specificheTecniche:sco:p73
type	DatoNP_Type
facets	Kind Value pattern [1-9]{1}[0-9]*

element Detrazione_Crediti_Type/DetrazioneFamiliari

diagram	
namespace	urn:www.agenziaentrate.gov.it:specificheTecniche:sco:p73
type	DatoNP_Type
facets	Kind Value pattern [1-9]{1}[0-9]*

element Detrazione_Crediti_Type/DetrazioneLavDip

diagram	
namespace	urn:www.agenziaentrate.gov.it:specificheTecniche:sco:p73
type	DatoNP_Type
facets	Kind Value pattern [1-9]{1}[0-9]*

element Detrazione_Crediti_Type/DetrazionePens

diagram	
---------	--

namespace	urn:www.agenziaentrate.gov.it:specificheTecniche:sco:p73
type	DatoNP_Type
facets	Kind Value pattern [1-9]{1}[0-9]*

element **Detrazione_Crediti_Type/DetrazioneAltriRedditi**

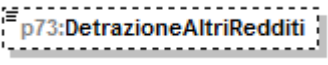
diagram	
namespace	urn:www.agenziaentrate.gov.it:specificheTecniche:sco:p73
type	DatoNP_Type
facets	Kind Value pattern [1-9]{1}[0-9]*

element **Detrazione_Crediti_Type/DetrazioneOneri**

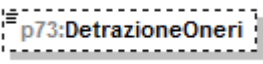
diagram	
namespace	urn:www.agenziaentrate.gov.it:specificheTecniche:sco:p73
type	DatoNP_Type
facets	Kind Value pattern [1-9]{1}[0-9]*

element **Detrazione_Crediti_Type/DetrazioneRistrutturazione**

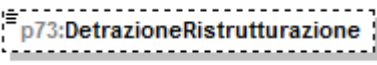
diagram	
namespace	urn:www.agenziaentrate.gov.it:specificheTecniche:sco:p73
type	DatoNP_Type
facets	Kind Value pattern [1-9]{1}[0-9]*

element **Detrazione_Crediti_Type/DetrazioniArredolmmobili**

diagram	
namespace	urn:www.agenziaentrate.gov.it:specificheTecniche:sco:p73
type	DatoNP_Type
facets	Kind Value pattern [1-9]{1}[0-9]*

element **Detrazione_Crediti_Type/DetrazioneRisparmioEnergetico**

diagram	
---------	---

namespace	urn:www.agenziaentrate.gov.it:specificheTecniche:sco:p73
type	DatoNP_Type
facets	Kind Value pattern [1-9]{1}[0-9]*

element Detrazione_Crediti_Type/DetrazioneLocEAgricoliGiovani

diagram	
namespace	urn:www.agenziaentrate.gov.it:specificheTecniche:sco:p73
type	DatoNP_Type
facets	Kind Value pattern [1-9]{1}[0-9]*

element Detrazione_Crediti_Type/AltreDetrazioni

diagram	
namespace	urn:www.agenziaentrate.gov.it:specificheTecniche:sco:p73
type	DatoNP_Type
facets	Kind Value pattern [1-9]{1}[0-9]*

element Detrazione_Crediti_Type/CreditoPrimaCasa

diagram	
namespace	urn:www.agenziaentrate.gov.it:specificheTecniche:sco:p73
type	DatoNP_Type
facets	Kind Value pattern [1-9]{1}[0-9]*

element Detrazione_Crediti_Type/CreditoOccupazione

diagram	
namespace	urn:www.agenziaentrate.gov.it:specificheTecniche:sco:p73
type	DatoNP_Type
facets	Kind Value pattern [1-9]{1}[0-9]*

element Detrazione_Crediti_Type/CreditoFondiPensione

diagram	
---------	--

namespace	urn:www.agenziaentrate.gov.it:specificheTecniche:sco:p73
type	DatoNP_Type
facets	Kind Value pattern [1-9]{1}[0-9]*

element Detrazione_Crediti_Type/CreditoMediazioni

diagram	
namespace	urn:www.agenziaentrate.gov.it:specificheTecniche:sco:p73
type	DatoNP_Type
facets	Kind Value pattern [1-9]{1}[0-9]*

element Detrazione_Crediti_Type/CreditoNegoziazione

diagram	
namespace	urn:www.agenziaentrate.gov.it:specificheTecniche:sco:p73
type	DatoNP_Type
facets	Kind Value pattern [1-9]{1}[0-9]*

element Detrazione_Crediti_Type/TotaleDetrazioniCrediti

diagram	
namespace	urn:www.agenziaentrate.gov.it:specificheTecniche:sco:p73
type	DatoNP_Type
facets	Kind Value pattern [1-9]{1}[0-9]*

complexType Detrazioni_Canoni_Locazione_Type

diagram	
namespace	urn:www.agenziaentrate.gov.it:specificheTecniche:sco:p73
children	p73:InquiliniAbitazionePrincipale p73:DipendentiTrasferiti

element **Detrazioni_Canoni_Locazione_Type/InquiliniAbitazionePrincipale**

diagram	
namespace	urn:www.agenziaentrate.gov.it:specificheTecniche:sco:p73
type	p73:Inquilini_Abitazione_Principale_Type
children	p73:Tipologia p73:GiorniPercentuale

element **Detrazioni_Canoni_Locazione_Type/DipendentiTrasferiti**

diagram	
namespace	urn:www.agenziaentrate.gov.it:specificheTecniche:sco:p73
type	p73:Giorni_Percentuale_Type
children	p73:Giorni p73:Percentuale

complexType **Detrazioni_Modulo_Type**

diagram	
namespace	urn:www.agenziaentrate.gov.it:specificheTecniche:sco:p73
children	p73:VeicoliDisabili p73:AcquistoCaniGuida p73:SpeseRateizzate p73:AltreSpese

element **Detrazioni_Modulo_Type/VeicoliDisabili**

diagram	<p>The diagram illustrates the structure of the <code>p73:Spese_Rateizzate_Type</code> element. It is a container element (represented by a rounded rectangle with a dashed border) that contains three child elements: <code>p73:VeicoliDisabili</code> (a dashed box), <code>p73:Codice</code> (a dashed box), and <code>p73:Importo</code> (a solid box). The <code>p73:VeicoliDisabili</code> element is connected to the container via a solid line, while <code>p73:Codice</code> and <code>p73:Importo</code> are connected via dashed lines.</p>
namespace	urn:www.agenziaentrate.gov.it:specificheTecniche:sco:p73
type	p73:Spese_Rateizzate_Type
children	p73:Codice p73:Importo

element **Detrazioni_Modulo_Type/AcquistoCaniGuida**

diagram	<p>The diagram illustrates the structure of the <code>p73:Spese_Rateizzate_Type</code> element. It is a container element (represented by a rounded rectangle with a dashed border) that contains three child elements: <code>p73:AcquistoCaniGuida</code> (a dashed box), <code>p73:Codice</code> (a dashed box), and <code>p73:Importo</code> (a solid box). The <code>p73:AcquistoCaniGuida</code> element is connected to the container via a solid line, while <code>p73:Codice</code> and <code>p73:Importo</code> are connected via dashed lines.</p>
namespace	urn:www.agenziaentrate.gov.it:specificheTecniche:sco:p73
type	p73:Spese_Rateizzate_Type
children	p73:Codice p73:Importo

element **Detrazioni_Modulo_Type/SpeseRateizzate**

diagram	<p>The diagram illustrates the structure of the <code>p73:Spese_Rateizzate_Anni_Precedenti_Type</code> element. It is a container element (represented by a rounded rectangle with a dashed border) that contains three child elements: <code>p73:SpeseRateizzate</code> (a dashed box), <code>p73:Codice</code> (a dashed box), and <code>p73:Importo</code> (a solid box). The <code>p73:SpeseRateizzate</code> element is connected to the container via a solid line, while <code>p73:Codice</code> and <code>p73:Importo</code> are connected via dashed lines.</p>
namespace	urn:www.agenziaentrate.gov.it:specificheTecniche:sco:p73
type	p73:Spese_Rateizzate_Anni_Precedenti_Type
children	p73:Codice p73:Importo

element **Detrazioni_Modulo_Type/AltreSpese**

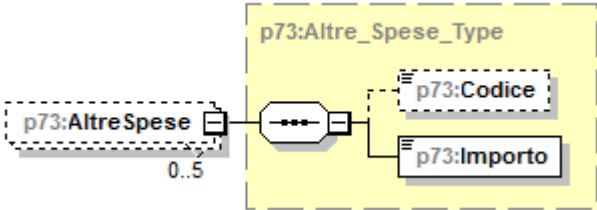
diagram	
namespace	urn:www.agenziaentrate.gov.it:specificheTecniche:sco:p73
type	p73:Altre Spese Type
children	p73:Codice p73:Importo

complexType **Detrazioni_Type**

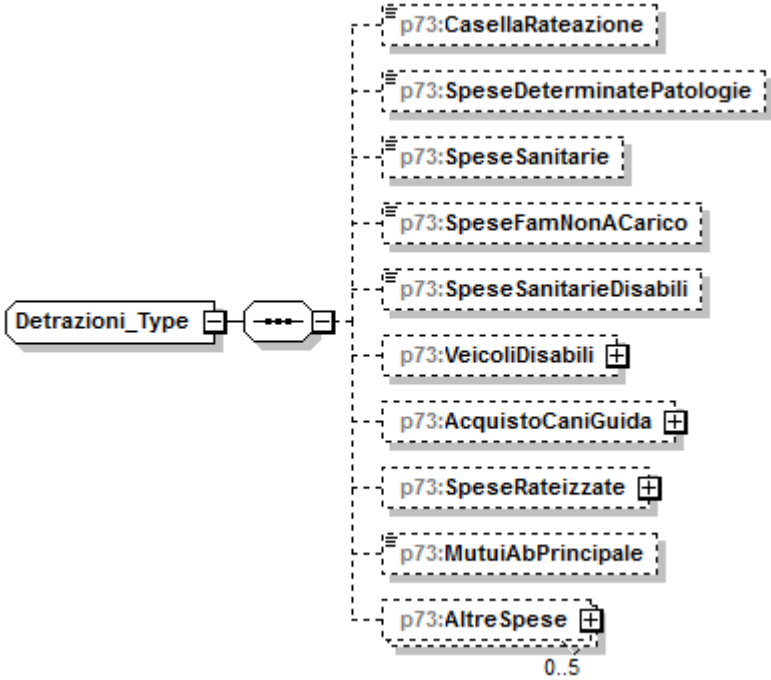
diagram	
namespace	urn:www.agenziaentrate.gov.it:specificheTecniche:sco:p73
children	p73:CasellaRateazione p73:SpeseDeterminatePatologie p73:SpeseSanitarie p73:SpeseFamNonACarico p73:SpeseSanitarieDisabili p73:VeicoliDisabili p73:AcquistoCaniGuida p73:SpeseRateizzate p73:MutuiAbPrincipale p73:AltreSpese

element **Detrazioni_Type/CasellaRateazione**

diagram	
namespace	urn:www.agenziaentrate.gov.it:specificheTecniche:sco:p73
type	DatoCB Type

facets	Kind pattern	Value [01]
--------	-----------------	---------------

element Detrazioni_Type/SpeseDeterminatePatologie

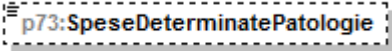
diagram		
namespace	urn:www.agenziaentrate.gov.it:specificheTecniche:sco:p73	
type	DatoNP_Type	
facets	Kind pattern	Value [1-9]{1}[0-9]*

element Detrazioni_Type/SpeseSanitarie

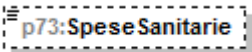
diagram		
namespace	urn:www.agenziaentrate.gov.it:specificheTecniche:sco:p73	
type	DatoNP_Type	
facets	Kind pattern	Value [1-9]{1}[0-9]*

element Detrazioni_Type/SpeseFamNonACarico

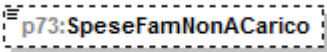
diagram		
namespace	urn:www.agenziaentrate.gov.it:specificheTecniche:sco:p73	
type	DatoNP_Type	
facets	Kind pattern	Value [1-9]{1}[0-9]*

element Detrazioni_Type/SpeseSanitarieDisabili

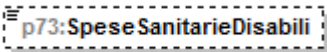
diagram		
namespace	urn:www.agenziaentrate.gov.it:specificheTecniche:sco:p73	
type	DatoNP_Type	
facets	Kind pattern	Value [1-9]{1}[0-9]*

element Detrazioni_Type/VeicoliDisabili

diagram	
namespace	urn:www.agenziaentrate.gov.it:specificheTecniche:sco:p73
type	p73:Spese_Rateizzate_Type
children	p73:Codice p73:Importo

element Detrazioni_Type/AcquistoCaniGuida

diagram	
namespace	urn:www.agenziaentrate.gov.it:specificheTecniche:sco:p73
type	p73:Spese_Rateizzate_Type
children	p73:Codice p73:Importo

element Detrazioni_Type/SpeseRateizzate

diagram	
namespace	urn:www.agenziaentrate.gov.it:specificheTecniche:sco:p73
type	p73:Spese_Rateizzate_Anni_Precedenti_Type
children	p73:Codice p73:Importo

element Detrazioni_Type/MutuiAbPrincipale

diagram	
namespace	urn:www.agenziaentrate.gov.it:specificheTecniche:sco:p73
type	DatoNP_Type

facets	Kind pattern	Value [1-9]{1}[0-9]*
--------	-----------------	-------------------------

element **Detrazioni_Type/AltreSpese**

diagram	
namespace	urn:www.agenziaentrate.gov.it:specificheTecniche:sco:p73
type	p73:Altre Spese Type
children	p73:Codice p73:Importo

complexType **Documento_P73_Type**

diagram	
namespace	urn:www.agenziaentrate.gov.it:specificheTecniche:sco:p73
children	p73:Frontespizio p73:DatiContabili p73:EsitiContabili

element **Documento_P73_Type/Frontespizio**

diagram	
namespace	urn:www.agenziaentrate.gov.it:specificheTecniche:sco:p73
type	p73:Frontespizio 730 Type
children	p73:SoggettoFiscale p73:DatiAnagrafici p73:DomicilioFiscale01012015 p73:DomicilioFiscale01012016 p73:CasiParticolariAddizionale

element **Documento_P73_Type/DatiContabili**

<p>diagram</p>	
<p>namespace</p>	<p>urn:www.agenziaentrate.gov.it:specificheTecniche:sco:p73</p>
<p>type</p>	<p>p73:Dati_Contabili_Type</p>
<p>children</p>	<p>p73:Familiari p73:QuadroA p73:QuadroB p73:QuadroC p73:QuadroD p73:QuadroE p73:QuadroF p73:QuadroG p73:ProspettoLiquidazione</p>

element **Documento_P73_Type/EsitiContabili**

<p>diagram</p>	
<p>namespace</p>	<p>urn:www.agenziaentrate.gov.it:specificheTecniche:sco:p73</p>
<p>children</p>	<p>p73:Conguaglio</p>

element **Documento_P73_Type/EsitiContabili/Conguaglio**

diagram	
namespace	urn:www.agenziaentrate.gov.it:specificheTecniche:sco:p73
type	p73:Conguaglio_Type
children	p73:NumeroRate p73:ImportoTrattenutoSaldo p73:ImportoTrattenutoAcconto p73:ImportoDaVersareF24Saldo p73:ImportoDaVersareF24Acconto p73:ImportoRimborsato p73:ImportoRimborsatoAgenzia p73:OpzioneInformativa

complexType **Domanda_Accatamento_Type**

diagram	
namespace	urn:www.agenziaentrate.gov.it:specificheTecniche:sco:p73
children	p73:Data p73:Numero p73:ProvinciaUfficio

element **Domanda_Accatamento_Type/Data**

diagram					
namespace	urn:www.agenziaentrate.gov.it:specificheTecniche:sco:p73				
type	DatoDT_Type				
facets	<table border="1"> <thead> <tr> <th>Kind</th> <th>Value</th> </tr> </thead> <tbody> <tr> <td>pattern</td> <td>((([0-9]{1,2}[0-9]{3,4}) (0[13578]1012)\d{4})) ((([0-9]{1,2}[0-9]{3,4}) (0[469]11)\d{4})) ((([0-9]{1,2}[0-9]{3,4}) (0[8]02)\d{4})) ((29)(02)([02468][048]00)) ((29)(02)([13579][26]00)) ((29)(02)([0-9][0-9][0][48])) ((29)(02)([0-9][0-9][2468][048])) ((29)(02)([0-9][0-9][13579][26]))</td> </tr> </tbody> </table>	Kind	Value	pattern	((([0-9]{1,2}[0-9]{3,4}) (0[13578]1012)\d{4})) ((([0-9]{1,2}[0-9]{3,4}) (0[469]11)\d{4})) ((([0-9]{1,2}[0-9]{3,4}) (0[8]02)\d{4})) ((29)(02)([02468][048]00)) ((29)(02)([13579][26]00)) ((29)(02)([0-9][0-9][0][48])) ((29)(02)([0-9][0-9][2468][048])) ((29)(02)([0-9][0-9][13579][26]))
Kind	Value				
pattern	((([0-9]{1,2}[0-9]{3,4}) (0[13578]1012)\d{4})) ((([0-9]{1,2}[0-9]{3,4}) (0[469]11)\d{4})) ((([0-9]{1,2}[0-9]{3,4}) (0[8]02)\d{4})) ((29)(02)([02468][048]00)) ((29)(02)([13579][26]00)) ((29)(02)([0-9][0-9][0][48])) ((29)(02)([0-9][0-9][2468][048])) ((29)(02)([0-9][0-9][13579][26]))				

element Domanda_Accatastamento_Type/Numero

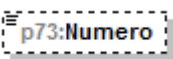
diagram	
namespace	urn:www.agenziaentrate.gov.it:specificheTecniche:sco:p73
type	DatoAN_Type
facets	Kind Value pattern ([0-9A-Z\-\]"){1}([0-9A-Z&:] ' - \., / ° ^\(\\ \\) À É È Ì Ò Ù Ú Û " \\ \\ \\ +)*

element Domanda_Accatastamento_Type/ProvinciaUfficio

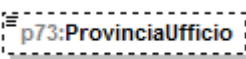
diagram	
namespace	urn:www.agenziaentrate.gov.it:specificheTecniche:sco:p73
type	PN_Type

complexType Domicilio_Fiscale_Type

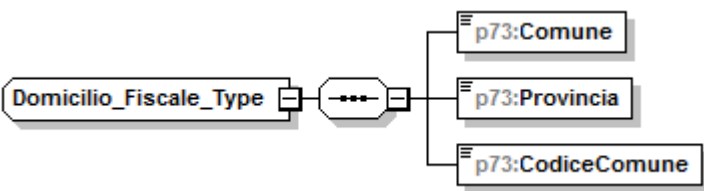
diagram	
namespace	urn:www.agenziaentrate.gov.it:specificheTecniche:sco:p73
children	p73:Comune p73:Provincia p73:CodiceComune

element Domicilio_Fiscale_Type/Comune

diagram	
namespace	urn:www.agenziaentrate.gov.it:specificheTecniche:sco:p73
type	DatoAN_Type
facets	Kind Value pattern ([0-9A-Z\-\]"){1}([0-9A-Z&:] ' - \., / ° ^\(\\ \\ \\ \\) À É È Ì Ò Ù Ú Û " \\ \\ \\ +)*

element Domicilio_Fiscale_Type/Provincia

diagram	
namespace	urn:www.agenziaentrate.gov.it:specificheTecniche:sco:p73
type	PR_Type

element **Domicilio_Fiscale_Type/CodiceComune**

diagram	
namespace	urn:www.agenziaentrate.gov.it:specificheTecniche:sco:p73
type	DatoAN_Type
facets	Kind Value pattern ([0-9A-Z\-\-]"){1}([0-9A-Z&#39; ! - \- _ / ° °\°\(\)\ À È É Ì Ò Ù Ú Û " \ \\ \ +)*

complexType **Eccedenze_Type**

diagram	
namespace	urn:www.agenziaentrate.gov.it:specificheTecniche:sco:p73
children	p73:lrpef p73:lrpefCompF24 p73:SostitutivaQuadroRT p73:SostitutivaQuadroRTcompF24 p73:CedolareSecca p73:CedolareSeccaCompF24 p73:CodiceRegione p73:AddRegionalelrpef p73:AddRegionalelrpefCompF24 p73:CodiceCatastaleComune p73:AddComunalelrpef p73:AddComunalelrpeff24

element **Eccedenze_Type/lrpef**

diagram	
namespace	urn:www.agenziaentrate.gov.it:specificheTecniche:sco:p73
type	DatoNP_Type
facets	Kind Value pattern [1-9]{1}[0-9]*

element **Eccedenze_Type/IrpefCompF24**

diagram					
namespace	urn:www.agenziaentrate.gov.it:specificheTecniche:sco:p73				
type	DatoNP_Type				
facets	<table border="1"> <tr> <td>Kind</td> <td>Value</td> </tr> <tr> <td>pattern</td> <td>[1-9]{1}[0-9]*</td> </tr> </table>	Kind	Value	pattern	[1-9]{1}[0-9]*
Kind	Value				
pattern	[1-9]{1}[0-9]*				

element **Eccedenze_Type/SostitutivaQuadroRT**

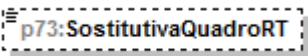
diagram					
namespace	urn:www.agenziaentrate.gov.it:specificheTecniche:sco:p73				
type	DatoNP_Type				
facets	<table border="1"> <tr> <td>Kind</td> <td>Value</td> </tr> <tr> <td>pattern</td> <td>[1-9]{1}[0-9]*</td> </tr> </table>	Kind	Value	pattern	[1-9]{1}[0-9]*
Kind	Value				
pattern	[1-9]{1}[0-9]*				

element **Eccedenze_Type/SostitutivaQuadroRTcompF24**

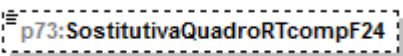
diagram					
namespace	urn:www.agenziaentrate.gov.it:specificheTecniche:sco:p73				
type	DatoNP_Type				
facets	<table border="1"> <tr> <td>Kind</td> <td>Value</td> </tr> <tr> <td>pattern</td> <td>[1-9]{1}[0-9]*</td> </tr> </table>	Kind	Value	pattern	[1-9]{1}[0-9]*
Kind	Value				
pattern	[1-9]{1}[0-9]*				

element **Eccedenze_Type/CedolareSecca**

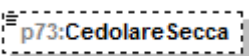
diagram					
namespace	urn:www.agenziaentrate.gov.it:specificheTecniche:sco:p73				
type	DatoNP_Type				
facets	<table border="1"> <tr> <td>Kind</td> <td>Value</td> </tr> <tr> <td>pattern</td> <td>[1-9]{1}[0-9]*</td> </tr> </table>	Kind	Value	pattern	[1-9]{1}[0-9]*
Kind	Value				
pattern	[1-9]{1}[0-9]*				

element **Eccedenze_Type/CedolareSeccaCompF24**

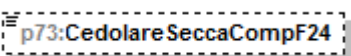
diagram					
namespace	urn:www.agenziaentrate.gov.it:specificheTecniche:sco:p73				
type	DatoNP_Type				
facets	<table border="1"> <tr> <td>Kind</td> <td>Value</td> </tr> <tr> <td>pattern</td> <td>[1-9]{1}[0-9]*</td> </tr> </table>	Kind	Value	pattern	[1-9]{1}[0-9]*
Kind	Value				
pattern	[1-9]{1}[0-9]*				

element **Eccedenze_Type/CodiceRegione**

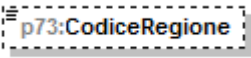
diagram																																															
namespace	urn:www.agenziaentrate.gov.it:specificheTecniche:sco:p73																																														
type	Codice Regione Type																																														
facets	<table border="0"> <tr> <td>Kind</td> <td>Value</td> </tr> <tr> <td>pattern</td> <td>{([0-9A-Z-])&quot;}{1}([0-9A-Z&amp;:] ' \" . / ° ^\(\\ \\) À É È Ì Ò Ù Ü &quot; \\ \\ \\ +)*</td> </tr> <tr><td>enumeration</td><td>1</td></tr> <tr><td>enumeration</td><td>2</td></tr> <tr><td>enumeration</td><td>3</td></tr> <tr><td>enumeration</td><td>4</td></tr> <tr><td>enumeration</td><td>5</td></tr> <tr><td>enumeration</td><td>6</td></tr> <tr><td>enumeration</td><td>7</td></tr> <tr><td>enumeration</td><td>8</td></tr> <tr><td>enumeration</td><td>9</td></tr> <tr><td>enumeration</td><td>10</td></tr> <tr><td>enumeration</td><td>11</td></tr> <tr><td>enumeration</td><td>12</td></tr> <tr><td>enumeration</td><td>13</td></tr> <tr><td>enumeration</td><td>14</td></tr> <tr><td>enumeration</td><td>15</td></tr> <tr><td>enumeration</td><td>16</td></tr> <tr><td>enumeration</td><td>17</td></tr> <tr><td>enumeration</td><td>18</td></tr> <tr><td>enumeration</td><td>19</td></tr> <tr><td>enumeration</td><td>20</td></tr> <tr><td>enumeration</td><td>21</td></tr> </table>	Kind	Value	pattern	{([0-9A-Z-])"}{1}([0-9A-Z&:] ' \" . / ° ^\(\\ \\) À É È Ì Ò Ù Ü " \\ \\ \\ +)*	enumeration	1	enumeration	2	enumeration	3	enumeration	4	enumeration	5	enumeration	6	enumeration	7	enumeration	8	enumeration	9	enumeration	10	enumeration	11	enumeration	12	enumeration	13	enumeration	14	enumeration	15	enumeration	16	enumeration	17	enumeration	18	enumeration	19	enumeration	20	enumeration	21
Kind	Value																																														
pattern	{([0-9A-Z-])"}{1}([0-9A-Z&:] ' \" . / ° ^\(\\ \\) À É È Ì Ò Ù Ü " \\ \\ \\ +)*																																														
enumeration	1																																														
enumeration	2																																														
enumeration	3																																														
enumeration	4																																														
enumeration	5																																														
enumeration	6																																														
enumeration	7																																														
enumeration	8																																														
enumeration	9																																														
enumeration	10																																														
enumeration	11																																														
enumeration	12																																														
enumeration	13																																														
enumeration	14																																														
enumeration	15																																														
enumeration	16																																														
enumeration	17																																														
enumeration	18																																														
enumeration	19																																														
enumeration	20																																														
enumeration	21																																														

element **Eccedenze_Type/AddRegionalelrpef**

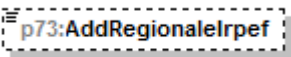
diagram					
namespace	urn:www.agenziaentrate.gov.it:specificheTecniche:sco:p73				
type	DatoNP Type				
facets	<table border="0"> <tr> <td>Kind</td> <td>Value</td> </tr> <tr> <td>pattern</td> <td>[1-9]{1}[0-9]*</td> </tr> </table>	Kind	Value	pattern	[1-9]{1}[0-9]*
Kind	Value				
pattern	[1-9]{1}[0-9]*				

element **Eccedenze_Type/AddRegionalelrpefCompF24**

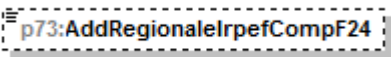
diagram					
namespace	urn:www.agenziaentrate.gov.it:specificheTecniche:sco:p73				
type	DatoNP Type				
facets	<table border="0"> <tr> <td>Kind</td> <td>Value</td> </tr> <tr> <td>pattern</td> <td>[1-9]{1}[0-9]*</td> </tr> </table>	Kind	Value	pattern	[1-9]{1}[0-9]*
Kind	Value				
pattern	[1-9]{1}[0-9]*				

element **Eccedenze_Type/CodiceCatastaleComune**

diagram	
namespace	urn:www.agenziaentrate.gov.it:specificheTecniche:sco:p73
type	restriction of DatoAN_Type
facets	Kind Value pattern ([0-9A-Z-] \"){1}([0-9A-Z&:] ' \- \., / ^ \^\(\ \)\À È É Ì Ò Ù Û " \ \\ \ +)*

element **Eccedenze_Type/AddComunalelrpef**

diagram	
namespace	urn:www.agenziaentrate.gov.it:specificheTecniche:sco:p73
type	DatoNP_Type
facets	Kind Value pattern [1-9]{1}[0-9]*

element **Eccedenze_Type/AddComunalelrpefF24**

diagram	
namespace	urn:www.agenziaentrate.gov.it:specificheTecniche:sco:p73
type	DatoNP_Type
facets	Kind Value pattern [1-9]{1}[0-9]*

complexType **Elemento_Integrativo_Type**

diagram	
namespace	urn:www.agenziaentrate.gov.it:specificheTecniche:sco:p73
children	p73:lrpef p73:AddizionaleRegionalelrpef p73:AddComunalelrpef p73:CedolareSecca

element **Elemento_Integrativo_Type/lrpef**

diagram	
namespace	urn:www.agenziaentrate.gov.it:specificheTecniche:sco:p73

type	DatoNP_Type
facets	Kind Value pattern [1-9]{1}[0-9]*

element **Elemento_Integrativo_Type/AddizionaleRegionaleIrpef**

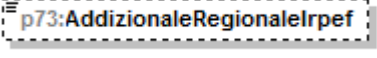
diagram	
namespace	urn:www.agenziaentrate.gov.it:specificheTecniche:sco:p73
type	DatoNP_Type
facets	Kind Value pattern [1-9]{1}[0-9]*

element **Elemento_Integrativo_Type/AddComunaleIrpef**

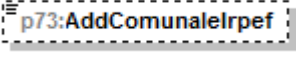
diagram	
namespace	urn:www.agenziaentrate.gov.it:specificheTecniche:sco:p73
type	DatoNP_Type
facets	Kind Value pattern [1-9]{1}[0-9]*

element **Elemento_Integrativo_Type/CedolareSecca**

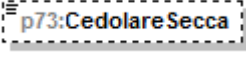
diagram	
namespace	urn:www.agenziaentrate.gov.it:specificheTecniche:sco:p73
type	DatoNP_Type
facets	Kind Value pattern [1-9]{1}[0-9]*

complexType **Esenzione_Add_Comunale_Type**

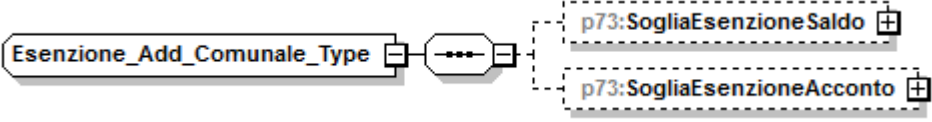
diagram	
namespace	urn:www.agenziaentrate.gov.it:specificheTecniche:sco:p73
children	p73:SogliaEsenzioneSaldo p73:SogliaEsenzioneAcconto

element **Esenzione_Add_Comunale_Type/SogliaEsenzioneSaldo**

diagram	
namespace	urn:www.agenziaentrate.gov.it:specificheTecniche:sco:p73
type	p73:Soglie_Esenzione_Type
children	p73:SogliaEsenzione p73:EsenzioneTotale

element **Esenzione_Add_Comunale_Type/SogliaEsenzioneAcconto**

diagram	
namespace	urn:www.agenziaentrate.gov.it:specificheTecniche:sco:p73
type	p73:Soglie_Esenzione_Type
children	p73:SogliaEsenzione p73:EsenzioneTotale

complexType **Esenzione_Bonus_Type**

diagram	
namespace	urn:www.agenziaentrate.gov.it:specificheTecniche:sco:p73
children	p73:TipologiaEsenzione p73:ParteRedditoEsente

element **Esenzione_Bonus_Type/TipologiaEsenzione**

diagram									
namespace	urn:www.agenziaentrate.gov.it:specificheTecniche:sco:p73								
type	restriction of DatoN1_Type								
facets	<table border="1"> <thead> <tr> <th>Kind</th> <th>Value</th> </tr> </thead> <tbody> <tr> <td>pattern</td> <td>[1-9]</td> </tr> <tr> <td>enumeration</td> <td>1</td> </tr> <tr> <td>enumeration</td> <td>2</td> </tr> </tbody> </table>	Kind	Value	pattern	[1-9]	enumeration	1	enumeration	2
Kind	Value								
pattern	[1-9]								
enumeration	1								
enumeration	2								

element Esenzione_Bonus_Type/ParteRedditoEsente

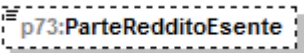
diagram					
namespace	urn:www.agenziaentrate.gov.it:specificheTecniche:sco:p73				
type	DatoNP_Type				
facets	<table border="1"> <thead> <tr> <th>Kind</th> <th>Value</th> </tr> </thead> <tbody> <tr> <td>pattern</td> <td>[1-9]{1}[0-9]*</td> </tr> </tbody> </table>	Kind	Value	pattern	[1-9]{1}[0-9]*
Kind	Value				
pattern	[1-9]{1}[0-9]*				

complexType Esito_Liquidazione_Type

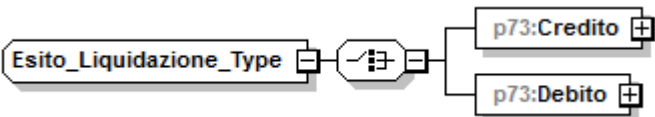
diagram	
namespace	urn:www.agenziaentrate.gov.it:specificheTecniche:sco:p73
children	p73:Credito p73:Debito

element Esito_Liquidazione_Type/Credito

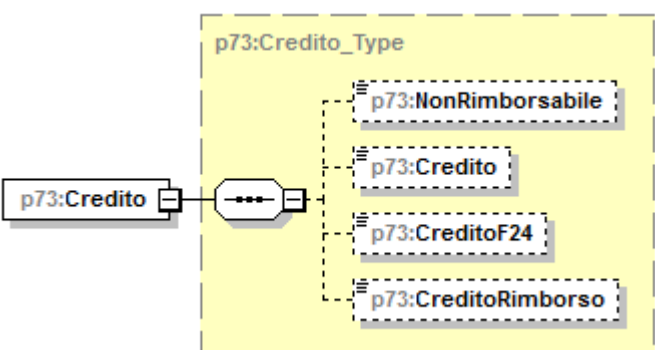
diagram	
namespace	urn:www.agenziaentrate.gov.it:specificheTecniche:sco:p73
type	p73:Credito_Type
children	p73:NonRimborsabile p73:Credito p73:CreditoF24 p73:CreditoRimborso

element Esito_Liquidazione_Type/Debito

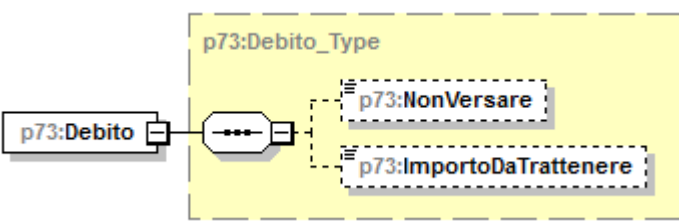
diagram	
namespace	urn:www.agenziaentrate.gov.it:specificheTecniche:sco:p73

type	p73:Debito_Type
children	p73:NonVersare p73:ImportoDaTrattenere

complexType Fabbricato_Agev_Type

diagram	
namespace	urn:www.agenziaentrate.gov.it:specificheTecniche:sco:p73
children	p73:NumeroRigoRiferimento p73:NumModuloRiferimento p73:DatiContratto p73:CasellaInf30Giorni p73:AnnoDichiarazioneIcilmu p73:StatoEmergenza

element Fabbricato_Agev_Type/NumeroRigoRiferimento

diagram																									
namespace	urn:www.agenziaentrate.gov.it:specificheTecniche:sco:p73																								
type	p73:Fabbricato_Agev_Numero_Rigo_Type																								
facets	<table border="0"> <thead> <tr> <th>Kind</th> <th>Value</th> </tr> </thead> <tbody> <tr> <td>pattern</td> <td>[1-9]{1}[0-9]*</td> </tr> <tr> <td>enumeration</td> <td>1</td> </tr> <tr> <td>enumeration</td> <td>2</td> </tr> <tr> <td>enumeration</td> <td>3</td> </tr> <tr> <td>enumeration</td> <td>4</td> </tr> <tr> <td>enumeration</td> <td>5</td> </tr> <tr> <td>enumeration</td> <td>6</td> </tr> <tr> <td>enumeration</td> <td>7</td> </tr> <tr> <td>enumeration</td> <td>8</td> </tr> <tr> <td>enumeration</td> <td>9</td> </tr> <tr> <td>enumeration</td> <td>10</td> </tr> </tbody> </table>	Kind	Value	pattern	[1-9]{1}[0-9]*	enumeration	1	enumeration	2	enumeration	3	enumeration	4	enumeration	5	enumeration	6	enumeration	7	enumeration	8	enumeration	9	enumeration	10
Kind	Value																								
pattern	[1-9]{1}[0-9]*																								
enumeration	1																								
enumeration	2																								
enumeration	3																								
enumeration	4																								
enumeration	5																								
enumeration	6																								
enumeration	7																								
enumeration	8																								
enumeration	9																								
enumeration	10																								

element Fabbricato_Agev_Type/NumModuloRiferimento

diagram					
namespace	urn:www.agenziaentrate.gov.it:specificheTecniche:sco:p73				
type	DatoNP_Type				
facets	<table border="0"> <thead> <tr> <th>Kind</th> <th>Value</th> </tr> </thead> <tbody> <tr> <td>pattern</td> <td>[1-9]{1}[0-9]*</td> </tr> </tbody> </table>	Kind	Value	pattern	[1-9]{1}[0-9]*
Kind	Value				
pattern	[1-9]{1}[0-9]*				

element **Fabbricato_Agev_Type/DatiContratto**

diagram	<p>The diagram illustrates the XSD extension structure. On the left, a dashed box represents the base type <code>p73:DatiContratto</code>. A solid line connects it to a yellow-shaded area labeled <code>p73:Dati_Contratto_Type (extension)</code>. Inside this area, five dashed boxes represent the added elements: <code>p73:DataRegContratto</code>, <code>p73:SerieContratto</code>, <code>p73:NumeroContratto</code>, <code>p73:Sottonumero</code>, and <code>p73:CodiceUfficio</code>. Below the yellow area, a solid line connects to a dashed box for <code>p73:IdentificativoContratto</code>. Each element is represented by a dashed box with a small icon of a horizontal bar on the left side.</p>
namespace	urn:www.agenziaentrate.gov.it:specificheTecniche:sco:p73
type	extension of p73:Dati_Contratto_Type
children	p73:DataRegContratto p73:SerieContratto p73:NumeroContratto p73:Sottonumero p73:CodiceUfficio p73:IdentificativoContratto

element **Fabbricato_Agev_Type/DatiContratto/IdentificativoContratto**

diagram	
namespace	urn:www.agenziaentrate.gov.it:specificheTecniche:sco:p73
type	DatoAN_Type
facets	Kind Value pattern ([0-9A-Z\-\]\"}{1}([0-9A-Z&#171; \" \-\ \.\ / ! \" \"\\(\\) À È É Ì Ò Ù Û " \\ \\ \\+)*

element **Fabbricato_Agev_Type/CasellaInf30Giorni**

diagram	
namespace	urn:www.agenziaentrate.gov.it:specificheTecniche:sco:p73
type	DatoCB_Type
facets	Kind Value pattern [01]

element **Fabbricato_Agev_Type/AnnoDichiarazioneIcilmu**

diagram	
namespace	urn:www.agenziaentrate.gov.it:specificheTecniche:sco:p73

type	DatoDA_Type
facets	Kind Value pattern (18 19 20)[0-9]{2}

element **Fabbricato_Agev_Type/StatoEmergenza**

diagram	
namespace	urn:www.agenziaentrate.gov.it:specificheTecniche:sco:p73
type	DatoCB_Type
facets	Kind Value pattern [01]

complexType **Fabbricato_Ord_Type**

diagram	
namespace	urn:www.agenziaentrate.gov.it:specificheTecniche:sco:p73
children	p73:Rendita p73:Utilizzo p73:GiorniPossesso p73:PercPossesso p73:CodiceCanone p73:CanoneLocazione p73:CasiParticolari p73:CasellaContinuazione p73:CodiceComune p73:OpzioneCedolare p73:CasellaCasiPartimu

element **Fabbricato_Ord_Type/Rendita**

diagram	
namespace	urn:www.agenziaentrate.gov.it:specificheTecniche:sco:p73
type	DatoNP_Type

facets	Kind pattern	Value [1-9]{1}[0-9]*
--------	-----------------	-------------------------

element Fabbricato_Ord_Type/Utilizzo

diagram		
namespace	urn:www.agenziaentrate.gov.it:specificheTecniche:sco:p73	
type	restriction of p73:Utilizzo_Fabbricato_Type	
facets	Kind pattern enumeration enumeration enumeration enumeration enumeration enumeration enumeration enumeration enumeration enumeration enumeration enumeration enumeration enumeration	Value [1-9]{1}[0-9]* 1 2 3 4 5 8 9 10 11 12 14 15 16 17

element Fabbricato_Ord_Type/GiorniPossesso

diagram		
namespace	urn:www.agenziaentrate.gov.it:specificheTecniche:sco:p73	
type	restriction of DatoNP_Type	
facets	Kind pattern	Value [1-9]{1}[0-9]*

element Fabbricato_Ord_Type/PercPossesso

diagram		
namespace	urn:www.agenziaentrate.gov.it:specificheTecniche:sco:p73	
type	DatoPC_Type	
facets	Kind pattern	Value [0-9]?[0-9](,\.d{1,3})? 100,(0{1,3})?

element Fabbricato_Ord_Type/CodiceCanone

diagram		
namespace	urn:www.agenziaentrate.gov.it:specificheTecniche:sco:p73	
type	p73:Codice_Canone_Type	

facets	Kind	Value
	pattern	[1-9]
	enumeration	1
	enumeration	2
	enumeration	3
	enumeration	4

element Fabbricato_Ord_Type/CanoneLocazione

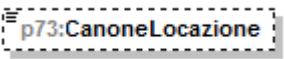
diagram					
namespace	urn:www.agenziaentrate.gov.it:specificheTecniche:sco:p73				
type	DatoNP_Type				
facets	<table border="1"> <tr> <td>Kind</td> <td>Value</td> </tr> <tr> <td>pattern</td> <td>[1-9]{1}[0-9]*</td> </tr> </table>	Kind	Value	pattern	[1-9]{1}[0-9]*
Kind	Value				
pattern	[1-9]{1}[0-9]*				

element Fabbricato_Ord_Type/CasiParticolari

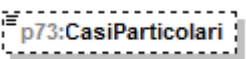
diagram															
namespace	urn:www.agenziaentrate.gov.it:specificheTecniche:sco:p73														
type	p73:Casi Particolari Fabbricato_Type														
facets	<table border="1"> <tr> <td>Kind</td> <td>Value</td> </tr> <tr> <td>pattern</td> <td>[1-9]</td> </tr> <tr> <td>enumeration</td> <td>1</td> </tr> <tr> <td>enumeration</td> <td>3</td> </tr> <tr> <td>enumeration</td> <td>4</td> </tr> <tr> <td>enumeration</td> <td>5</td> </tr> <tr> <td>enumeration</td> <td>6</td> </tr> </table>	Kind	Value	pattern	[1-9]	enumeration	1	enumeration	3	enumeration	4	enumeration	5	enumeration	6
Kind	Value														
pattern	[1-9]														
enumeration	1														
enumeration	3														
enumeration	4														
enumeration	5														
enumeration	6														

element Fabbricato_Ord_Type/CasellaContinuazione

diagram					
namespace	urn:www.agenziaentrate.gov.it:specificheTecniche:sco:p73				
type	DatoCB_Type				
facets	<table border="1"> <tr> <td>Kind</td> <td>Value</td> </tr> <tr> <td>pattern</td> <td>[01]</td> </tr> </table>	Kind	Value	pattern	[01]
Kind	Value				
pattern	[01]				

element Fabbricato_Ord_Type/CodiceComune

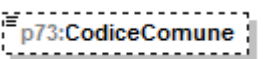
diagram					
namespace	urn:www.agenziaentrate.gov.it:specificheTecniche:sco:p73				
type	restriction of DatoAN_Type				
facets	<table border="1"> <tr> <td>Kind</td> <td>Value</td> </tr> <tr> <td>pattern</td> <td>([0-9A-Z\-\- &quot;]{1})([0-9A-Z&amp;:] ' - \., / ° '\'\'(\)À É È Ì Ò Ù Û &quot;; \\ / +)*</td> </tr> </table>	Kind	Value	pattern	([0-9A-Z\-\- "]{1})([0-9A-Z&:] ' - \., / ° '\'\'(\)À É È Ì Ò Ù Û "; \\ / +)*
Kind	Value				
pattern	([0-9A-Z\-\- "]{1})([0-9A-Z&:] ' - \., / ° '\'\'(\)À É È Ì Ò Ù Û "; \\ / +)*				

element **Fabbricato_Ord_Type/OpzioneCedolare**

diagram	
namespace	urn:www.agenziaentrate.gov.it:specificheTecniche:sco:p73
type	DatoCB_Type
facets	Kind Value pattern [01]

element **Fabbricato_Ord_Type/CasellaCasiPartImu**

diagram	
namespace	urn:www.agenziaentrate.gov.it:specificheTecniche:sco:p73
type	restriction of DatoN1_Type
facets	Kind Value pattern [1-9] enumeration 1 enumeration 2 enumeration 3

complexType **Familiari_Type**

diagram	
namespace	urn:www.agenziaentrate.gov.it:specificheTecniche:sco:p73
children	p73:PrimoModulo p73:Modulo

element **Familiari_Type/PrimoModulo**

diagram	
namespace	urn:www.agenziaentrate.gov.it:specificheTecniche:sco:p73

type	p73:Primo Modulo Familiari Type
children	p73:Coniuge p73:PrimoFiglio p73:Familiari p73:PercUlteriore p73:FigliAffidoPread

element Familiari_Type/Modulo

diagram	
namespace	urn:www.agenziaentrate.gov.it:specificheTecniche:sco:p73
type	p73:Modulo Familiari Type
children	p73:Coniuge p73:PrimoFiglio p73:Familiari

complexType Fondo_Pensione_Dipendenti_Pubblici_Type

diagram	
namespace	urn:www.agenziaentrate.gov.it:specificheTecniche:sco:p73
children	p73:Contributi p73:QuotaTFR

element Fondo_Pensione_Dipendenti_Pubblici_Type/Contributi

diagram	
namespace	urn:www.agenziaentrate.gov.it:specificheTecniche:sco:p73
type	p73:Contributi Previdenza Complementare Type
children	p73:EsclusiDalSostituto p73:NonEsclusiDalSostituto

element **Fondo_Pensione_Dipendenti_Pubblici_Type/QuotaTFR**

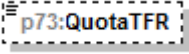
diagram	
namespace	urn:www.agenziaentrate.gov.it:specificheTecniche:sco:p73
type	DatoNP_Type
facets	Kind Value pattern [1-9]{1}[0-9]*

complexType **Frontespizio_730_Type**

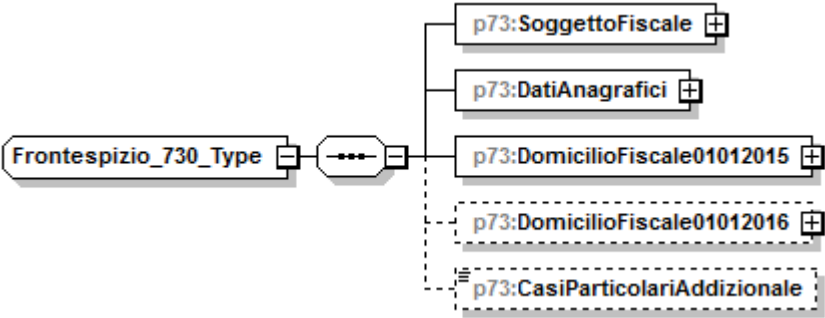
diagram	
namespace	urn:www.agenziaentrate.gov.it:specificheTecniche:sco:p73
children	p73:SoggettoFiscale p73:DatiAnagrafici p73:DomicilioFiscale01012015 p73:DomicilioFiscale01012016 p73:CasiParticolariAddizionale

element **Frontespizio_730_Type/SoggettoFiscale**

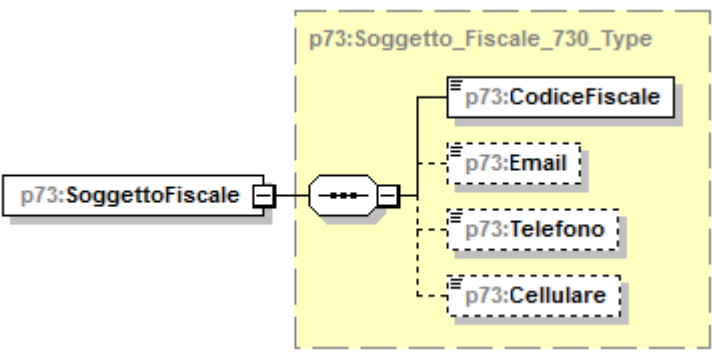
diagram	
namespace	urn:www.agenziaentrate.gov.it:specificheTecniche:sco:p73
type	p73:Soggetto_Fiscale_730_Type
children	p73:CodiceFiscale p73:Email p73:Telefono p73:Cellulare

element **Frontespizio_730_Type/DatiAnagrafici**

diagram	
namespace	urn:www.agenziaentrate.gov.it:specificheTecniche:sco:p73
type	Dati_Anagrafici_Type
children	Cognome Nome Sesso DataNascita ComuneNascita ProvinciaNascita

element **Frontespizio_730_Type/DomicilioFiscale01012015**

diagram	
namespace	urn:www.agenziaentrate.gov.it:specificheTecniche:sco:p73
type	p73:Domicilio_Fiscale_Type
children	p73:Comune p73:Provincia p73:CodiceComune

element **Frontespizio_730_Type/DomicilioFiscale01012016**

diagram	
namespace	urn:www.agenziaentrate.gov.it:specificheTecniche:sco:p73

type	p73:Domicilio Fiscale Type
children	p73:Comune p73:Provincia p73:CodiceComune

element Frontespizio_730_Type/CasiParticolariAddizionale

diagram	
namespace	urn:www.agenziaentrate.gov.it:specificheTecniche:sco:p73
type	DatoCB Type
facets	Kind Value pattern [01]

complexType Giorni_Percentuale_Type

diagram	
namespace	urn:www.agenziaentrate.gov.it:specificheTecniche:sco:p73
children	p73:Giorni p73:Percentuale

element Giorni_Percentuale_Type/Giorni

diagram	
namespace	urn:www.agenziaentrate.gov.it:specificheTecniche:sco:p73
type	DatoNP Type
facets	Kind Value pattern [1-9]{1}[0-9]*

element Giorni_Percentuale_Type/Percentuale

diagram	
namespace	urn:www.agenziaentrate.gov.it:specificheTecniche:sco:p73
type	DatoPC Type
facets	Kind Value pattern [0-9]?[0-9](,\d{1,3})? 100,0{1,3}?

complexType Imposta_Lorda_Type

diagram	
namespace	urn:www.agenziaentrate.gov.it:specificheTecniche:sco:p73
children	p73:RedditoComplessivo p73:DeduzioneAbitazPrincipale p73:OneriDeducibili p73:RedditoImponibile p73:CompensiAttSport p73:ImportoImpostaLorda

element Imposta_Lorda_Type/RedditoComplessivo

diagram					
namespace	urn:www.agenziaentrate.gov.it:specificheTecniche:sco:p73				
type	DatoNP_Type				
facets	<table border="1"> <tr> <td>Kind</td> <td>Value</td> </tr> <tr> <td>pattern</td> <td>[1-9]{1}[0-9]*</td> </tr> </table>	Kind	Value	pattern	[1-9]{1}[0-9]*
Kind	Value				
pattern	[1-9]{1}[0-9]*				

element Imposta_Lorda_Type/DeduzioneAbitazPrincipale

diagram					
namespace	urn:www.agenziaentrate.gov.it:specificheTecniche:sco:p73				
type	DatoNP_Type				
facets	<table border="1"> <tr> <td>Kind</td> <td>Value</td> </tr> <tr> <td>pattern</td> <td>[1-9]{1}[0-9]*</td> </tr> </table>	Kind	Value	pattern	[1-9]{1}[0-9]*
Kind	Value				
pattern	[1-9]{1}[0-9]*				

element Imposta_Lorda_Type/OneriDeducibili

diagram					
namespace	urn:www.agenziaentrate.gov.it:specificheTecniche:sco:p73				
type	DatoNP_Type				
facets	<table border="1"> <tr> <td>Kind</td> <td>Value</td> </tr> <tr> <td>pattern</td> <td>[1-9]{1}[0-9]*</td> </tr> </table>	Kind	Value	pattern	[1-9]{1}[0-9]*
Kind	Value				
pattern	[1-9]{1}[0-9]*				

element **Imposta_Lorda_Type/Redditolmponibile**

diagram	
namespace	urn:www.agenziaentrate.gov.it:specificheTecniche:sco:p73
type	DatoNP_Type
facets	Kind Value pattern [1-9]{1}[0-9]*

element **Imposta_Lorda_Type/CompensiAttSport**

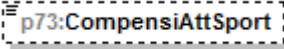
diagram	
namespace	urn:www.agenziaentrate.gov.it:specificheTecniche:sco:p73
type	DatoNP_Type
facets	Kind Value pattern [1-9]{1}[0-9]*

element **Imposta_Lorda_Type/ImportolImpostaLorda**

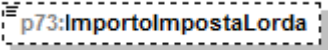
diagram	
namespace	urn:www.agenziaentrate.gov.it:specificheTecniche:sco:p73
type	DatoNP_Type
facets	Kind Value pattern [1-9]{1}[0-9]*

complexType **Imposta_Netta_Type**

<p>diagram</p>	
<p>namespace</p>	<p>urn:www.agenziaentrate.gov.it:specificheTecniche:sco:p73</p>
<p>children</p>	<p>p73:ImportoImpostaNetta p73:CredAltriSisma p73:CredAbitazSisma p73:CredImpEstere p73:CredErogCultura p73:CredCanNonPerc p73:CredDetrazIncapienti p73:Ritenute p73:Differenza p73:EccedenzaIrpef p73:AccontiVersati p73:RestituzioneBonus p73:CredRimborsatiSost p73:BonusIrpefSpettante p73:BonusIrpefRiconosciuto p73:RestituzioneBonusIrpef</p>

element **Imposta_Netta_Type/ImportoImpostaNetta**

<p>diagram</p>					
<p>namespace</p>	<p>urn:www.agenziaentrate.gov.it:specificheTecniche:sco:p73</p>				
<p>type</p>	<p>DatoNP_Type</p>				
<p>facets</p>	<table border="1"> <tr> <td>Kind</td> <td>Value</td> </tr> <tr> <td>pattern</td> <td>[1-9]{1}[0-9]*</td> </tr> </table>	Kind	Value	pattern	[1-9]{1}[0-9]*
Kind	Value				
pattern	[1-9]{1}[0-9]*				

element **Imposta_Netta_Type/CredAltriSisma**

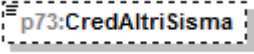
diagram					
namespace	urn:www.agenziaentrate.gov.it:specificheTecniche:sco:p73				
type	DatoNP_Type				
facets	<table border="1"> <tr> <td>Kind</td> <td>Value</td> </tr> <tr> <td>pattern</td> <td>[1-9]{1}[0-9]*</td> </tr> </table>	Kind	Value	pattern	[1-9]{1}[0-9]*
Kind	Value				
pattern	[1-9]{1}[0-9]*				

element **Imposta_Netta_Type/CredAbitazSisma**

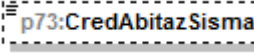
diagram					
namespace	urn:www.agenziaentrate.gov.it:specificheTecniche:sco:p73				
type	DatoNP_Type				
facets	<table border="1"> <tr> <td>Kind</td> <td>Value</td> </tr> <tr> <td>pattern</td> <td>[1-9]{1}[0-9]*</td> </tr> </table>	Kind	Value	pattern	[1-9]{1}[0-9]*
Kind	Value				
pattern	[1-9]{1}[0-9]*				

element **Imposta_Netta_Type/CredImpEstere**

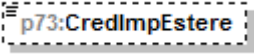
diagram					
namespace	urn:www.agenziaentrate.gov.it:specificheTecniche:sco:p73				
type	DatoNP_Type				
facets	<table border="1"> <tr> <td>Kind</td> <td>Value</td> </tr> <tr> <td>pattern</td> <td>[1-9]{1}[0-9]*</td> </tr> </table>	Kind	Value	pattern	[1-9]{1}[0-9]*
Kind	Value				
pattern	[1-9]{1}[0-9]*				

element **Imposta_Netta_Type/CredErogCultura**

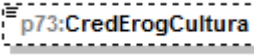
diagram					
namespace	urn:www.agenziaentrate.gov.it:specificheTecniche:sco:p73				
type	DatoNP_Type				
facets	<table border="1"> <tr> <td>Kind</td> <td>Value</td> </tr> <tr> <td>pattern</td> <td>[1-9]{1}[0-9]*</td> </tr> </table>	Kind	Value	pattern	[1-9]{1}[0-9]*
Kind	Value				
pattern	[1-9]{1}[0-9]*				

element **Imposta_Netta_Type/CredCanNonPerc**

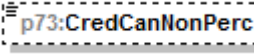
diagram					
namespace	urn:www.agenziaentrate.gov.it:specificheTecniche:sco:p73				
type	DatoNP_Type				
facets	<table border="1"> <tr> <td>Kind</td> <td>Value</td> </tr> <tr> <td>pattern</td> <td>[1-9]{1}[0-9]*</td> </tr> </table>	Kind	Value	pattern	[1-9]{1}[0-9]*
Kind	Value				
pattern	[1-9]{1}[0-9]*				

element **Imposta_Netta_Type/CredDetrazIncapienti**

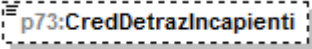
diagram	
namespace	urn:www.agenziaentrate.gov.it:specificheTecniche:sco:p73
type	DatoNP_Type
facets	Kind Value pattern [1-9]{1}[0-9]*

element **Imposta_Netta_Type/Ritenute**

diagram	
namespace	urn:www.agenziaentrate.gov.it:specificheTecniche:sco:p73
type	DatoNP_Type
facets	Kind Value pattern [1-9]{1}[0-9]*

element **Imposta_Netta_Type/Differenza**

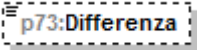
diagram	
namespace	urn:www.agenziaentrate.gov.it:specificheTecniche:sco:p73
type	DatoNU_Type
facets	Kind Value pattern (\-[1-9] [1-9])[0-9]*

element **Imposta_Netta_Type/EccedenzaIrpéf**

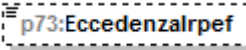
diagram	
namespace	urn:www.agenziaentrate.gov.it:specificheTecniche:sco:p73
type	DatoNU_Type
facets	Kind Value pattern (\-[1-9] [1-9])[0-9]*

element **Imposta_Netta_Type/AccountiVersati**

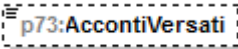
diagram	
namespace	urn:www.agenziaentrate.gov.it:specificheTecniche:sco:p73
type	DatoNP_Type
facets	Kind Value pattern [1-9]{1}[0-9]*

element Imposta_Netta_Type/RestituzioneBonus

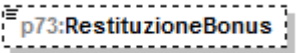
diagram	
namespace	urn:www.agenziaentrate.gov.it:specificheTecniche:sco:p73
type	DatoNP_Type
facets	Kind Value pattern [1-9]{1}[0-9]*

element Imposta_Netta_Type/CredRimborsatiSost

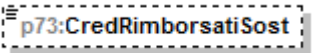
diagram	
namespace	urn:www.agenziaentrate.gov.it:specificheTecniche:sco:p73
type	DatoNP_Type
facets	Kind Value pattern [1-9]{1}[0-9]*

element Imposta_Netta_Type/BonusIrpefSpettante

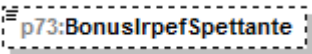
diagram	
namespace	urn:www.agenziaentrate.gov.it:specificheTecniche:sco:p73
type	DatoNP_Type
facets	Kind Value pattern [1-9]{1}[0-9]*

element Imposta_Netta_Type/BonusIrpefRiconosciuto

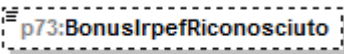
diagram	
namespace	urn:www.agenziaentrate.gov.it:specificheTecniche:sco:p73
type	DatoNP_Type
facets	Kind Value pattern [1-9]{1}[0-9]*

element Imposta_Netta_Type/RestituzioneBonusIrpef

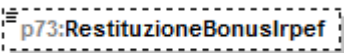
diagram	
namespace	urn:www.agenziaentrate.gov.it:specificheTecniche:sco:p73
type	DatoNP_Type
facets	Kind Value pattern [1-9]{1}[0-9]*

complexType Imposte_Rimborsate_Type

diagram	
namespace	urn:www.agenziaentrate.gov.it:specificheTecniche:sco:p73
children	p73:TipoReddito p73:TassazioneSeparata

element Imposte_Rimborsate_Type/TipoReddito

diagram																					
namespace	urn:www.agenziaentrate.gov.it:specificheTecniche:sco:p73																				
type	p73:Tipo_Reddito_Data8_Type																				
facets	<table border="1"> <thead> <tr> <th>Kind</th> <th>Value</th> </tr> </thead> <tbody> <tr> <td>pattern</td> <td>[1-9]{1}[0-9]*</td> </tr> <tr> <td>enumeration</td> <td>1</td> </tr> <tr> <td>enumeration</td> <td>2</td> </tr> <tr> <td>enumeration</td> <td>3</td> </tr> <tr> <td>enumeration</td> <td>4</td> </tr> <tr> <td>enumeration</td> <td>5</td> </tr> <tr> <td>enumeration</td> <td>6</td> </tr> <tr> <td>enumeration</td> <td>7</td> </tr> <tr> <td>enumeration</td> <td>8</td> </tr> </tbody> </table>	Kind	Value	pattern	[1-9]{1}[0-9]*	enumeration	1	enumeration	2	enumeration	3	enumeration	4	enumeration	5	enumeration	6	enumeration	7	enumeration	8
Kind	Value																				
pattern	[1-9]{1}[0-9]*																				
enumeration	1																				
enumeration	2																				
enumeration	3																				
enumeration	4																				
enumeration	5																				
enumeration	6																				
enumeration	7																				
enumeration	8																				

element Imposte_Rimborsate_Type/TassazioneSeparata

diagram	
namespace	urn:www.agenziaentrate.gov.it:specificheTecniche:sco:p73
type	p73:Tassazione_Separata_Type
children	p73:Opzione p73:Anno p73:RedditoRitenute

complexType **Incremento_Produttivita_Type**

diagram	
namespace	urn:www.agenziaentrate.gov.it:specificheTecniche:sco:p73
children	p73:ImportoTassazOrdinaria p73:ImportoImpostaSostitutiva p73:RitenuteImpostaSostitutiva p73:Art51Ordinaria p73:Art51Sostitutiva p73:TassazOrdinaria p73:TassazSostitutiva

element **Incremento_Produttivita_Type/ImportoTassazOrdinaria**

diagram					
namespace	urn:www.agenziaentrate.gov.it:specificheTecniche:sco:p73				
type	DatoNP_Type				
facets	<table border="1"> <tr> <td>Kind</td> <td>Value</td> </tr> <tr> <td>pattern</td> <td>[1-9]{1}[0-9]*</td> </tr> </table>	Kind	Value	pattern	[1-9]{1}[0-9]*
Kind	Value				
pattern	[1-9]{1}[0-9]*				

element **Incremento_Produttivita_Type/ImportoImpostaSostitutiva**

diagram					
namespace	urn:www.agenziaentrate.gov.it:specificheTecniche:sco:p73				
type	DatoNP_Type				
facets	<table border="1"> <tr> <td>Kind</td> <td>Value</td> </tr> <tr> <td>pattern</td> <td>[1-9]{1}[0-9]*</td> </tr> </table>	Kind	Value	pattern	[1-9]{1}[0-9]*
Kind	Value				
pattern	[1-9]{1}[0-9]*				

element **Incremento_Produttivita_Type/RitenuteImpostaSostitutiva**

diagram					
namespace	urn:www.agenziaentrate.gov.it:specificheTecniche:sco:p73				
type	DatoNP_Type				
facets	<table border="1"> <tr> <td>Kind</td> <td>Value</td> </tr> <tr> <td>pattern</td> <td>[1-9]{1}[0-9]*</td> </tr> </table>	Kind	Value	pattern	[1-9]{1}[0-9]*
Kind	Value				
pattern	[1-9]{1}[0-9]*				

element Incremento_Produttivita_Type/Art51Ordinaria

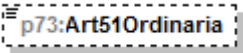
diagram					
namespace	urn:www.agenziaentrate.gov.it:specificheTecniche:sco:p73				
type	DatoNP_Type				
facets	<table border="1"> <tr> <td>Kind</td> <td>Value</td> </tr> <tr> <td>pattern</td> <td>[1-9]{1}[0-9]*</td> </tr> </table>	Kind	Value	pattern	[1-9]{1}[0-9]*
Kind	Value				
pattern	[1-9]{1}[0-9]*				

element Incremento_Produttivita_Type/Art51Sostitutiva

diagram					
namespace	urn:www.agenziaentrate.gov.it:specificheTecniche:sco:p73				
type	DatoNP_Type				
facets	<table border="1"> <tr> <td>Kind</td> <td>Value</td> </tr> <tr> <td>pattern</td> <td>[1-9]{1}[0-9]*</td> </tr> </table>	Kind	Value	pattern	[1-9]{1}[0-9]*
Kind	Value				
pattern	[1-9]{1}[0-9]*				

element Incremento_Produttivita_Type/TassazOrdinaria

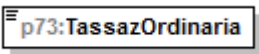
diagram					
namespace	urn:www.agenziaentrate.gov.it:specificheTecniche:sco:p73				
type	DatoCB_Type				
facets	<table border="1"> <tr> <td>Kind</td> <td>Value</td> </tr> <tr> <td>pattern</td> <td>[01]</td> </tr> </table>	Kind	Value	pattern	[01]
Kind	Value				
pattern	[01]				

element Incremento_Produttivita_Type/TassazSostitutiva

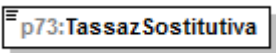
diagram					
namespace	urn:www.agenziaentrate.gov.it:specificheTecniche:sco:p73				
type	DatoCB_Type				
facets	<table border="1"> <tr> <td>Kind</td> <td>Value</td> </tr> <tr> <td>pattern</td> <td>[01]</td> </tr> </table>	Kind	Value	pattern	[01]
Kind	Value				
pattern	[01]				

complexType Inquilini_Abitazione_Principale_Type

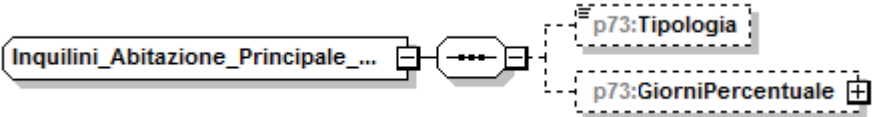
diagram	
namespace	urn:www.agenziaentrate.gov.it:specificheTecniche:sco:p73
children	p73:Tipologia p73:GiorniPercentuale

element **Inquilini_Abitazione_Principale_Type/Tipologia**

diagram													
namespace	urn:www.agenziaentrate.gov.it:specificheTecniche:sco:p73												
type	p73:Tipo Inquilino Type												
facets	<table border="0"> <tr> <td>Kind</td> <td>Value</td> </tr> <tr> <td>pattern</td> <td>[1-9]{1}[0-9]*</td> </tr> <tr> <td>enumeration</td> <td>1</td> </tr> <tr> <td>enumeration</td> <td>2</td> </tr> <tr> <td>enumeration</td> <td>3</td> </tr> <tr> <td>enumeration</td> <td>4</td> </tr> </table>	Kind	Value	pattern	[1-9]{1}[0-9]*	enumeration	1	enumeration	2	enumeration	3	enumeration	4
Kind	Value												
pattern	[1-9]{1}[0-9]*												
enumeration	1												
enumeration	2												
enumeration	3												
enumeration	4												

element **Inquilini_Abitazione_Principale_Type/GiorniPercentuale**

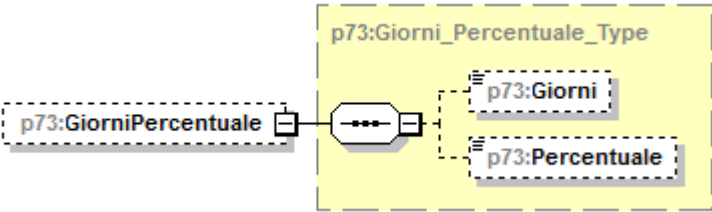
diagram	
namespace	urn:www.agenziaentrate.gov.it:specificheTecniche:sco:p73
type	p73:Giorni_Percentuale Type
children	p73:Giorni p73:Percentuale

complexType **Intervento_Ricupero_Patrimonio_Edilizio_Type**

diagram	
namespace	urn:www.agenziaentrate.gov.it:specificheTecniche:sco:p73
children	p73:Anno p73:Periodo p73:CodiceFiscale p73:CasellaInterventiParticolari p73:CodiceSituazioniParticolari p73:AnnoSituazioniParticolari p73:RideterminazioneRate p73:NRate p73:Spesa p73:NOrdineImmobile

element **Intervento_Ricupero_Patrimonio_Edilizio_Type/Anno**

diagram																											
namespace	urn:www.agenziaentrate.gov.it:specificheTecniche:sco:p73																										
type	restriction of p73:Anno Ricupero Patrimonio Edilizio Type																										
facets	<table border="0"> <thead> <tr> <th>Kind</th> <th>Value</th> </tr> </thead> <tbody> <tr> <td>pattern</td> <td>[1-9]{1}[0-9]*</td> </tr> <tr> <td>enumeration</td> <td>2005</td> </tr> <tr> <td>enumeration</td> <td>2006</td> </tr> <tr> <td>enumeration</td> <td>2007</td> </tr> <tr> <td>enumeration</td> <td>2008</td> </tr> <tr> <td>enumeration</td> <td>2009</td> </tr> <tr> <td>enumeration</td> <td>2010</td> </tr> <tr> <td>enumeration</td> <td>2011</td> </tr> <tr> <td>enumeration</td> <td>2012</td> </tr> <tr> <td>enumeration</td> <td>2013</td> </tr> <tr> <td>enumeration</td> <td>2014</td> </tr> <tr> <td>enumeration</td> <td>2015</td> </tr> </tbody> </table>	Kind	Value	pattern	[1-9]{1}[0-9]*	enumeration	2005	enumeration	2006	enumeration	2007	enumeration	2008	enumeration	2009	enumeration	2010	enumeration	2011	enumeration	2012	enumeration	2013	enumeration	2014	enumeration	2015
Kind	Value																										
pattern	[1-9]{1}[0-9]*																										
enumeration	2005																										
enumeration	2006																										
enumeration	2007																										
enumeration	2008																										
enumeration	2009																										
enumeration	2010																										
enumeration	2011																										
enumeration	2012																										
enumeration	2013																										
enumeration	2014																										
enumeration	2015																										

element **Intervento_Ricupero_Patrimonio_Edilizio_Type/Periodo**

diagram	
namespace	urn:www.agenziaentrate.gov.it:specificheTecniche:sco:p73

type	p73:Periodo Spese Ristrutturazione Type	
facets	Kind	Value
	pattern	[1-9]
	enumeration	1
	enumeration	2
	enumeration	3
	enumeration	4

element **Intervento_Ricupero_Patrimonio_Edilizio_Type/CodiceFiscale**

diagram		
namespace	urn:www.agenziaentrate.gov.it:specificheTecniche:sco:p73	
type	DatoCF Type	
facets	Kind	Value
	pattern	[0-9]{11}[[A-Z]{6}[0-9LMNPQRSTUUV]{2}[[A-Z]{1}[0-9LMNPQRSTUUV]{2}[[A-Z]{1}[0-9LMNPQRSTUUV]{3}[[A-Z]{1}

element **Intervento_Ricupero_Patrimonio_Edilizio_Type/CasellaInterventiParticolari**

diagram		
namespace	urn:www.agenziaentrate.gov.it:specificheTecniche:sco:p73	
type	restriction of DatoN1 Type	
facets	Kind	Value
	pattern	[1-9]
	enumeration	1
	enumeration	3
	enumeration	4

element **Intervento_Ricupero_Patrimonio_Edilizio_Type/CodiceSituazioniParticolari**

diagram		
namespace	urn:www.agenziaentrate.gov.it:specificheTecniche:sco:p73	
type	p73:Casella Codice Type	
facets	Kind	Value
	pattern	[1-9]
	enumeration	1
	enumeration	4

element **Intervento_Ricupero_Patrimonio_Edilizio_Type/AnnoSituazioniParticolari**

diagram		
namespace	urn:www.agenziaentrate.gov.it:specificheTecniche:sco:p73	
type	p73:Anno Patrimonio Edilizio Situazioni Particolari Type	
facets	Kind	Value
	pattern	[1-9]{1}[0-9]*
	enumeration	2011

element Intervento_Ricupero_Patrimonio_Edilizio_Type/RideterminazioneRate

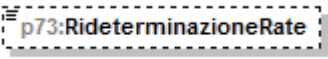
diagram							
namespace	urn:www.agenziaentrate.gov.it:specificheTecniche:sco:p73						
type	p73:Rideterminazione Rate Type						
facets	<table border="0"> <tr> <td>Kind</td> <td>Value</td> </tr> <tr> <td>pattern</td> <td>[1-9]{1}[0-9]*</td> </tr> <tr> <td>enumeration</td> <td>10</td> </tr> </table>	Kind	Value	pattern	[1-9]{1}[0-9]*	enumeration	10
Kind	Value						
pattern	[1-9]{1}[0-9]*						
enumeration	10						

element Intervento_Ricupero_Patrimonio_Edilizio_Type/NRate

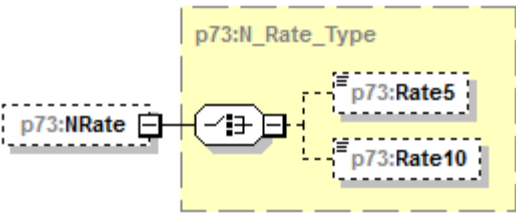
diagram	
namespace	urn:www.agenziaentrate.gov.it:specificheTecniche:sco:p73
type	p73:N Rate Type
children	p73:Rate5 p73:Rate10

element Intervento_Ricupero_Patrimonio_Edilizio_Type/Spesa

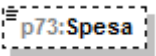
diagram					
namespace	urn:www.agenziaentrate.gov.it:specificheTecniche:sco:p73				
type	DatoNP Type				
facets	<table border="0"> <tr> <td>Kind</td> <td>Value</td> </tr> <tr> <td>pattern</td> <td>[1-9]{1}[0-9]*</td> </tr> </table>	Kind	Value	pattern	[1-9]{1}[0-9]*
Kind	Value				
pattern	[1-9]{1}[0-9]*				

element Intervento_Ricupero_Patrimonio_Edilizio_Type/NOrdineImmobile

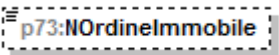
diagram					
namespace	urn:www.agenziaentrate.gov.it:specificheTecniche:sco:p73				
type	DatoNP Type				
facets	<table border="0"> <tr> <td>Kind</td> <td>Value</td> </tr> <tr> <td>pattern</td> <td>[1-9]{1}[0-9]*</td> </tr> </table>	Kind	Value	pattern	[1-9]{1}[0-9]*
Kind	Value				
pattern	[1-9]{1}[0-9]*				

complexType Intervento_Risparmio_Energetico_Type

diagram	
namespace	urn:www.agenziaentrate.gov.it:specificheTecniche:sco:p73
children	p73:TipIntervento p73:Anno p73:Periodo2013 p73:CasiParticolari p73:RideterminazioneRate p73:RipartizioneRate p73:NumeroRata p73:Spesa

element Intervento_Risparmio_Energetico_Type/TipIntervento

diagram																	
namespace	urn:www.agenziaentrate.gov.it:specificheTecniche:sco:p73																
type	p73:Tipo_Intervento_Type																
facets	<table border="1"> <thead> <tr> <th>Kind</th> <th>Value</th> </tr> </thead> <tbody> <tr> <td>pattern</td> <td>[1-9]</td> </tr> <tr> <td>enumeration</td> <td>1</td> </tr> <tr> <td>enumeration</td> <td>2</td> </tr> <tr> <td>enumeration</td> <td>3</td> </tr> <tr> <td>enumeration</td> <td>4</td> </tr> <tr> <td>enumeration</td> <td>5</td> </tr> <tr> <td>enumeration</td> <td>6</td> </tr> </tbody> </table>	Kind	Value	pattern	[1-9]	enumeration	1	enumeration	2	enumeration	3	enumeration	4	enumeration	5	enumeration	6
Kind	Value																
pattern	[1-9]																
enumeration	1																
enumeration	2																
enumeration	3																
enumeration	4																
enumeration	5																
enumeration	6																

element Intervento_Risparmio_Energetico_Type/Anno

diagram																			
namespace	urn:www.agenziaentrate.gov.it:specificheTecniche:sco:p73																		
type	restriction of p73:Anno_Risparmio_Energetico_Type																		
facets	<table border="1"> <thead> <tr> <th>Kind</th> <th>Value</th> </tr> </thead> <tbody> <tr> <td>pattern</td> <td>[1-9]{1}[0-9]*</td> </tr> <tr> <td>enumeration</td> <td>2008</td> </tr> <tr> <td>enumeration</td> <td>2010</td> </tr> <tr> <td>enumeration</td> <td>2011</td> </tr> <tr> <td>enumeration</td> <td>2012</td> </tr> <tr> <td>enumeration</td> <td>2013</td> </tr> <tr> <td>enumeration</td> <td>2014</td> </tr> <tr> <td>enumeration</td> <td>2015</td> </tr> </tbody> </table>	Kind	Value	pattern	[1-9]{1}[0-9]*	enumeration	2008	enumeration	2010	enumeration	2011	enumeration	2012	enumeration	2013	enumeration	2014	enumeration	2015
Kind	Value																		
pattern	[1-9]{1}[0-9]*																		
enumeration	2008																		
enumeration	2010																		
enumeration	2011																		
enumeration	2012																		
enumeration	2013																		
enumeration	2014																		
enumeration	2015																		

element **Intervento_Risparmio_Energetico_Type/Periodo2013**

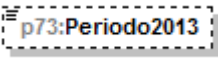
diagram									
namespace	urn:www.agenziaentrate.gov.it:specificheTecniche:sco:p73								
type	restriction of DatoN1_Type								
facets	<table> <thead> <tr> <th>Kind</th> <th>Value</th> </tr> </thead> <tbody> <tr> <td>pattern</td> <td>[1-9]</td> </tr> <tr> <td>enumeration</td> <td>1</td> </tr> <tr> <td>enumeration</td> <td>2</td> </tr> </tbody> </table>	Kind	Value	pattern	[1-9]	enumeration	1	enumeration	2
Kind	Value								
pattern	[1-9]								
enumeration	1								
enumeration	2								

element **Intervento_Risparmio_Energetico_Type/CasiParticolari**

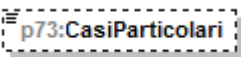
diagram											
namespace	urn:www.agenziaentrate.gov.it:specificheTecniche:sco:p73										
type	p73:Casi Particolari Risp Ener Type										
facets	<table> <thead> <tr> <th>Kind</th> <th>Value</th> </tr> </thead> <tbody> <tr> <td>pattern</td> <td>[1-9]</td> </tr> <tr> <td>enumeration</td> <td>1</td> </tr> <tr> <td>enumeration</td> <td>2</td> </tr> <tr> <td>enumeration</td> <td>3</td> </tr> </tbody> </table>	Kind	Value	pattern	[1-9]	enumeration	1	enumeration	2	enumeration	3
Kind	Value										
pattern	[1-9]										
enumeration	1										
enumeration	2										
enumeration	3										

element **Intervento_Risparmio_Energetico_Type/RideterminazioneRate**

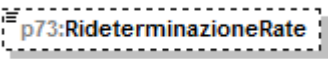
diagram																					
namespace	urn:www.agenziaentrate.gov.it:specificheTecniche:sco:p73																				
type	p73:Rate Risparmio Energetico Type																				
facets	<table> <thead> <tr> <th>Kind</th> <th>Value</th> </tr> </thead> <tbody> <tr> <td>pattern</td> <td>[1-9]{1}[0-9]*</td> </tr> <tr> <td>enumeration</td> <td>3</td> </tr> <tr> <td>enumeration</td> <td>4</td> </tr> <tr> <td>enumeration</td> <td>5</td> </tr> <tr> <td>enumeration</td> <td>6</td> </tr> <tr> <td>enumeration</td> <td>7</td> </tr> <tr> <td>enumeration</td> <td>8</td> </tr> <tr> <td>enumeration</td> <td>9</td> </tr> <tr> <td>enumeration</td> <td>10</td> </tr> </tbody> </table>	Kind	Value	pattern	[1-9]{1}[0-9]*	enumeration	3	enumeration	4	enumeration	5	enumeration	6	enumeration	7	enumeration	8	enumeration	9	enumeration	10
Kind	Value																				
pattern	[1-9]{1}[0-9]*																				
enumeration	3																				
enumeration	4																				
enumeration	5																				
enumeration	6																				
enumeration	7																				
enumeration	8																				
enumeration	9																				
enumeration	10																				

element **Intervento_Risparmio_Energetico_Type/RipartizioneRate**

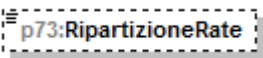
diagram							
namespace	urn:www.agenziaentrate.gov.it:specificheTecniche:sco:p73						
type	p73:Ripart Risparmio Energetico Type						
facets	<table> <thead> <tr> <th>Kind</th> <th>Value</th> </tr> </thead> <tbody> <tr> <td>pattern</td> <td>[1-9]{1}[0-9]*</td> </tr> <tr> <td>enumeration</td> <td>8</td> </tr> </tbody> </table>	Kind	Value	pattern	[1-9]{1}[0-9]*	enumeration	8
Kind	Value						
pattern	[1-9]{1}[0-9]*						
enumeration	8						

enumeration	9
enumeration	10

element Intervento_Risparmio_Energetico_Type/NumeroRata

diagram																	
namespace	urn:www.agenziaentrate.gov.it:specificheTecniche:sco:p73																
type	p73:Numero_Rata_Risparmio_Energetico_Type																
facets	<table border="1"> <thead> <tr> <th>Kind</th> <th>Value</th> </tr> </thead> <tbody> <tr> <td>pattern</td> <td>[1-9]{1}[0-9]*</td> </tr> <tr> <td>enumeration</td> <td>1</td> </tr> <tr> <td>enumeration</td> <td>2</td> </tr> <tr> <td>enumeration</td> <td>3</td> </tr> <tr> <td>enumeration</td> <td>4</td> </tr> <tr> <td>enumeration</td> <td>5</td> </tr> <tr> <td>enumeration</td> <td>8</td> </tr> </tbody> </table>	Kind	Value	pattern	[1-9]{1}[0-9]*	enumeration	1	enumeration	2	enumeration	3	enumeration	4	enumeration	5	enumeration	8
Kind	Value																
pattern	[1-9]{1}[0-9]*																
enumeration	1																
enumeration	2																
enumeration	3																
enumeration	4																
enumeration	5																
enumeration	8																

element Intervento_Risparmio_Energetico_Type/Spesa

diagram					
namespace	urn:www.agenziaentrate.gov.it:specificheTecniche:sco:p73				
type	DatoNP_Type				
facets	<table border="1"> <thead> <tr> <th>Kind</th> <th>Value</th> </tr> </thead> <tbody> <tr> <td>pattern</td> <td>[1-9]{1}[0-9]*</td> </tr> </tbody> </table>	Kind	Value	pattern	[1-9]{1}[0-9]*
Kind	Value				
pattern	[1-9]{1}[0-9]*				

complexType Lavoro_Dipendente_Type

diagram	
namespace	urn:www.agenziaentrate.gov.it:specificheTecniche:sco:p73
children	p73:TipologiaReddito p73:TipoContratto p73:Reddito

element Lavoro_Dipendente_Type/TipologiaReddito

diagram									
namespace	urn:www.agenziaentrate.gov.it:specificheTecniche:sco:p73								
type	p73:Tipo_Reddito_Da1a6_Type								
facets	<table border="1"> <thead> <tr> <th>Kind</th> <th>Value</th> </tr> </thead> <tbody> <tr> <td>pattern</td> <td>[1-9]</td> </tr> <tr> <td>enumeration</td> <td>1</td> </tr> <tr> <td>enumeration</td> <td>2</td> </tr> </tbody> </table>	Kind	Value	pattern	[1-9]	enumeration	1	enumeration	2
Kind	Value								
pattern	[1-9]								
enumeration	1								
enumeration	2								

	enumeration	3
	enumeration	4
	enumeration	5
	enumeration	6

element Lavoro_Dipendente_Type/TipoContratto

diagram									
namespace	urn:www.agenziaentrate.gov.it:specificheTecniche:sco:p73								
type	p73:Indeterminato_Determinato_Type								
facets	<table border="1"> <thead> <tr> <th>Kind</th> <th>Value</th> </tr> </thead> <tbody> <tr> <td>pattern</td> <td>[1-9]</td> </tr> <tr> <td>enumeration</td> <td>1</td> </tr> <tr> <td>enumeration</td> <td>2</td> </tr> </tbody> </table>	Kind	Value	pattern	[1-9]	enumeration	1	enumeration	2
Kind	Value								
pattern	[1-9]								
enumeration	1								
enumeration	2								

element Lavoro_Dipendente_Type/Reddito

diagram					
namespace	urn:www.agenziaentrate.gov.it:specificheTecniche:sco:p73				
type	DatoNP_Type				
facets	<table border="1"> <thead> <tr> <th>Kind</th> <th>Value</th> </tr> </thead> <tbody> <tr> <td>pattern</td> <td>[1-9]{1}[0-9]*</td> </tr> </tbody> </table>	Kind	Value	pattern	[1-9]{1}[0-9]*
Kind	Value				
pattern	[1-9]{1}[0-9]*				

complexType Misura_Acconti_Type

diagram	
namespace	urn:www.agenziaentrate.gov.it:specificheTecniche:sco:p73
children	p73:IrpefMisuralInferiore p73:AddComunaleMisuralInferiore p73:CedolareSeccaMisuralInferiore p73:NumeroRate

element Misura_Acconti_Type/IrpefMisuralInferiore

diagram	
---------	--

namespace	urn:www.agenziaentrate.gov.it:specificheTecniche:sco:p73
type	p73:Casella_Acconto_Type
children	p73:Casella p73:ImportoMisuralInferiore

element **Misura_Acconti_Type/AddComunaleMisuralInferiore**

diagram	
namespace	urn:www.agenziaentrate.gov.it:specificheTecniche:sco:p73
type	p73:Casella_Acconto_Type
children	p73:Casella p73:ImportoMisuralInferiore

element **Misura_Acconti_Type/CedolareSeccaMisuralInferiore**

diagram	
namespace	urn:www.agenziaentrate.gov.it:specificheTecniche:sco:p73
type	p73:Casella_Acconto_Type
children	p73:Casella p73:ImportoMisuralInferiore

element **Misura_Acconti_Type/NumeroRate**

diagram																	
namespace	urn:www.agenziaentrate.gov.it:specificheTecniche:sco:p73																
type	restriction of DatoN1_Type																
facets	<table border="1"> <thead> <tr> <th>Kind</th> <th>Value</th> </tr> </thead> <tbody> <tr> <td>pattern</td> <td>[1-9]</td> </tr> <tr> <td>enumeration</td> <td>2</td> </tr> <tr> <td>enumeration</td> <td>3</td> </tr> <tr> <td>enumeration</td> <td>4</td> </tr> <tr> <td>enumeration</td> <td>5</td> </tr> <tr> <td>enumeration</td> <td>6</td> </tr> <tr> <td>enumeration</td> <td>7</td> </tr> </tbody> </table>	Kind	Value	pattern	[1-9]	enumeration	2	enumeration	3	enumeration	4	enumeration	5	enumeration	6	enumeration	7
Kind	Value																
pattern	[1-9]																
enumeration	2																
enumeration	3																
enumeration	4																
enumeration	5																
enumeration	6																
enumeration	7																

complexType Modulo_Altri_Reddito_Type

diagram	
namespace	urn:www.agenziaentrate.gov.it:specificheTecniche:sco:p73
children	p73:RedditiDiCapitale p73:RedditiTassazioneSeparata

element Modulo_Altri_Reddito_Type/RedditiDiCapitale

diagram	
namespace	urn:www.agenziaentrate.gov.it:specificheTecniche:sco:p73
type	p73:Redditi_Capitale_Type
children	p73:Utili p73:AltriRedditiDiCapitale p73:LavoroAutonomo p73:RedditiDiversi p73:RedditiDiversiDetraz

element Modulo_Altri_Reddito_Type/RedditiTassazioneSeparata

diagram	
namespace	urn:www.agenziaentrate.gov.it:specificheTecniche:sco:p73
type	p73:Redditi_Tassazione_Separata_Type
children	p73:RedditiErede p73:ImposteRimborsate

complexType **Modulo_Crediti_Imposta_Type**

<p>diagram</p>	
<p>namespace</p>	<p>urn:www.agenziaentrate.gov.it:specificheTecniche:sco:p73</p>
<p>children</p>	<p>p73:CreditiImpostaFondiPensione p73:CreditiImpostaRedditiEsteri p73:CreditoPrimaCasaSismaAbruzzo p73:CreditoAltriSismaAbruzzo p73:CreditoNegoziazione</p>

element **Modulo_Crediti_Imposta_Type/CreditiImpostaFondiPensione**

<p>diagram</p>	
<p>namespace</p>	<p>urn:www.agenziaentrate.gov.it:specificheTecniche:sco:p73</p>
<p>type</p>	<p>p73:Crediti_Imposta_Fondi_Pensione_Type</p>
<p>children</p>	<p>p73:AnnoAnticipazione p73:Reintegro p73:SommaReintegrata p73:CreditoAnno</p>

element **Modulo_Crediti_Imposta_Type/CreditiImpostaRedditiEsteri**

<p>diagram</p>	
<p>namespace</p>	<p>urn:www.agenziaentrate.gov.it:specificheTecniche:sco:p73</p>
<p>type</p>	<p>p73:Crediti_Imposta_Redditi_Esteri_Type</p>
<p>children</p>	<p>p73:StatoEestero p73:Anno p73:RedditoEestero p73:ImpostaEstera p73:RedditoComplessivo p73:Imposta_Lorda p73:ImpostaNetta p73:CreditoDichiarazioniPrecedenti p73:DiCuiStatoEestero</p>

element **Modulo_Crediti_Imposta_Type/CreditoPrimaCasaSismaAbruzzo**

<p>diagram</p>	
<p>namespace</p>	<p>urn:www.agenziaentrate.gov.it:specificheTecniche:sco:p73</p>
<p>type</p>	<p>p73:Credito_Immobile_Sisma_Abruzzo_Type</p>
<p>children</p>	<p>p73:CodiceFiscale p73:NumeroRata p73:TotaleCredito</p>

element **Modulo_Crediti_Imposta_Type/CreditoAltriSismaAbruzzo**

diagram	
namespace	urn:www.agenziaentrate.gov.it:specificheTecniche:sco:p73
type	p73:Credito_Imposta_Altri_Sisma_Abruzzo_Type
children	p73:Impresa_Professione p73:CreditoImmobileSismaAbruzzo p73:Rateazione

element **Modulo_Crediti_Imposta_Type/CreditoNegoziazione**

diagram	
namespace	urn:www.agenziaentrate.gov.it:specificheTecniche:sco:p73
type	p73:Modulo_Credito_Negoziatore_Type
children	p73:CreditoSpettante

complexType **Modulo_Credito_Negoziatore_Type**

diagram	
namespace	urn:www.agenziaentrate.gov.it:specificheTecniche:sco:p73
children	p73:CreditoSpettante

element **Modulo_Credito_Negoziatore_Type/CreditoSpettante**

diagram					
namespace	urn:www.agenziaentrate.gov.it:specificheTecniche:sco:p73				
type	DatoNP_Type				
facets	<table border="1"> <thead> <tr> <th>Kind</th> <th>Value</th> </tr> </thead> <tbody> <tr> <td>pattern</td> <td>[1-9]{1}[0-9]*</td> </tr> </tbody> </table>	Kind	Value	pattern	[1-9]{1}[0-9]*
Kind	Value				
pattern	[1-9]{1}[0-9]*				

complexType **Modulo_Fabbricato_Type**

diagram	
namespace	urn:www.agenziaentrate.gov.it:specificheTecniche:sco:p73
children	p73:FabbricatoOrd p73:FabbricatoAgev

element **Modulo_Fabbricato_Type/FabbricatoOrd**

diagram	
namespace	urn:www.agenziaentrate.gov.it:specificheTecniche:sco:p73
type	p73:Fabbricato_Ord_Type
children	p73:Rendita p73:Utilizzo p73:GiorniPossesso p73:PercPossesso p73:CodiceCanone p73:CanoneLocazione p73:CasiParticolari p73:CasellaContinuazione p73:CodiceComune p73:OpzioneCedolare p73:CasellaCasiPartImu

element **Modulo_Fabbricato_Type/FabbricatoAgev**

diagram	
namespace	urn:www.agenziaentrate.gov.it:specificheTecniche:sco:p73
type	p73:Fabbricato_Agev_Type
children	p73:NumeroRigoRiferimento p73:NumModuloRiferimento p73:DatiContratto p73:CasellaInf30Giorni p73:AnnoDichiarazioneIcilmu p73:StatoEmergenza

complexType **Modulo_Familiari_Type**

diagram	
namespace	urn:www.agenziaentrate.gov.it:specificheTecniche:sco:p73
children	p73:Coniuge p73:PrimoFiglio p73:Familiari

element **Modulo_Familiari_Type/Coniuge**

diagram	
namespace	urn:www.agenziaentrate.gov.it:specificheTecniche:sco:p73
type	p73:Dati_Coniuge_Type

element **Modulo_Familiari_Type/Familiari**

diagram	
namespace	urn:www.agenziaentrate.gov.it:specificheTecniche:sco:p73
type	extension of p73:Dati_Familiare_Type
children	p73:CodiceFiscale p73:Mesi p73:MesiMinore p73:PercDetraz p73:PercDetrazCon p73:Affidamento p73:Tipo

element **Modulo_Familiari_Type/Familiari/Tipo**

diagram											
namespace	urn:www.agenziaentrate.gov.it:specificheTecniche:sco:p73										
type	restriction of DatoAN_Type										
facets	<table border="0"> <tr> <td>Kind</td> <td>Value</td> </tr> <tr> <td>pattern</td> <td>{([0-9A-Z-] \"){1}([0-9A-Z&amp;] ' - \., /° ^\(\\)À È É Ì Ò Ù Ü \&quot; \\ / +)*</td> </tr> <tr> <td>enumeration</td> <td>F</td> </tr> <tr> <td>enumeration</td> <td>D</td> </tr> <tr> <td>enumeration</td> <td>A</td> </tr> </table>	Kind	Value	pattern	{([0-9A-Z-] \"){1}([0-9A-Z&] ' - \., /° ^\(\\)À È É Ì Ò Ù Ü \" \\ / +)*	enumeration	F	enumeration	D	enumeration	A
Kind	Value										
pattern	{([0-9A-Z-] \"){1}([0-9A-Z&] ' - \., /° ^\(\\)À È É Ì Ò Ù Ü \" \\ / +)*										
enumeration	F										
enumeration	D										
enumeration	A										

complexType **Modulo_Lavoro_Dip_Type**

diagram	
namespace	urn:www.agenziaentrate.gov.it:specificheTecniche:sco:p73
children	p73:LavoroDipendente p73:AltriRedditiAssLavDip p73:Bonuslrpef

element **Modulo_Lavoro_Dip_Type/LavoroDipendente**

diagram	
namespace	urn:www.agenziaentrate.gov.it:specificheTecniche:sco:p73
type	p73:Lavoro_Dipendente_Type
children	p73:TipologiaReddito p73:TipoContratto p73:Reddito

element **Modulo_Lavoro_Dip_Type/AltriRedditiAssLavDip**

diagram	
namespace	urn:www.agenziaentrate.gov.it:specificheTecniche:sco:p73
type	p73:Altri_Redditi_Ass_Lav_Type
children	p73:AssegnoDelConiuge p73:ImportoRedditoAssimilato

element **Modulo_Lavoro_Dip_Type/BonusIrpef**

diagram	
namespace	urn:www.agenziaentrate.gov.it:specificheTecniche:sco:p73
children	p73:Esenzione

element **Modulo_Lavoro_Dip_Type/BonusIrpef/Esenzione**

diagram	
namespace	urn:www.agenziaentrate.gov.it:specificheTecniche:sco:p73

type	p73:Esenzione Bonus Type
children	p73:TipologiaEsenzione p73:ParteRedditoEsente

complexType **Modulo_Oneri_Type**

diagram	
namespace	urn:www.agenziaentrate.gov.it:specificheTecniche:sco:p73
children	p73:SpeseDetrazioni p73:SpeseDeduzioni p73:InterventoRecuperoPatrimonioEdilizio p73:DatiCatastaliRecuperoPatrimonioEdilizio p73:InterventoRisparmioEnergético p73:CanoniLocazione p73:DatiAltreDetrazioni p73:SpeseArredo

element **Modulo_Oneri_Type/SpeseDetrazioni**

diagram	
namespace	urn:www.agenziaentrate.gov.it:specificheTecniche:sco:p73
type	p73:Detrazioni Modulo Type
children	p73:VeicoliDisabili p73:AcquistoCaniGuida p73:SpeseRateizzate p73:AltreSpese

element **Modulo_Oneri_Type/SpeseDeduzioni**

diagram	
namespace	urn:www.agenziaentrate.gov.it:specificheTecniche:sco:p73
type	p73:Deduzioni_Modulo_Type
children	p73:AssegnoConiuge p73:AltriOneri p73:AcquistoCostruzioneAbitLocazione

element **Modulo_Oneri_Type/InterventoRecuperoPatrimonioEdilizio**

diagram	
namespace	urn:www.agenziaentrate.gov.it:specificheTecniche:sco:p73
type	p73:Intervento_Recupero_Patrimonio_Edilizio_Type
children	p73:Anno p73:Periodo p73:CodiceFiscale p73:CasellaInterventiParticolari p73:CodiceSituazioniParticolari p73:AnnoSituazioniParticolari p73:RideterminazioneRate p73:NRate p73:Spesa p73:NOrdineImmobile

element **Modulo_Oneri_Type/DatiCatastaliRecuperoPatrimonioEdilizio**

diagram	
namespace	urn:www.agenziaentrate.gov.it:specificheTecniche:sco:p73
type	p73:Sezione_Dati_Catastali_Recupero_Patrimonio_Edilizio_Type
children	p73:DatiCatastaliRecuperoPatrimonioEdilizio p73:DatiRegistrazioneAccatamentoRecuperoPatrimonio_Edilizio

element **Modulo_Oneri_Type/InterventoRisparmioEnergetico**

diagram	
namespace	urn:www.agenziaentrate.gov.it:specificheTecniche:sco:p73
type	p73:Intervento_Risparmio_Energetico_Type
children	p73:TipoIntervento p73:Anno p73:Periodo2013 p73:CasiParticolari p73:RideterminazioneRate p73:RipartizioneRate p73:NumeroRata p73:Spesa

element **Modulo_Oneri_Type/CanoniLocazione**

diagram	
---------	--

namespace	urn:www.agenziaentrate.gov.it:specificheTecniche:sco:p73
type	p73:Detrazioni_Canoni_Locazione_Type
children	p73:InquiliniAbitazionePrincipale p73:DipendentiTrasferiti

element Modulo_Oneri_Type/DatiAltreDetrazioni

diagram	
namespace	urn:www.agenziaentrate.gov.it:specificheTecniche:sco:p73
type	p73:Dati_Altre_Detrazioni_Modulo_Type
children	p73:AltreDetrazioni

element Modulo_Oneri_Type/SpeseArredo

diagram	
namespace	urn:www.agenziaentrate.gov.it:specificheTecniche:sco:p73
type	p73:Spese_Arredo_Type
children	p73:NumeroRata p73:Importo

complexType Modulo_PL_Type

diagram	
namespace	urn:www.agenziaentrate.gov.it:specificheTecniche:sco:p73
children	p73:CredImpEstero

element **Modulo_PL_Type/CredImpEestero**

<p>diagram</p>	
<p>namespace</p>	<p>urn:www.agenziaentrate.gov.it:specificheTecniche:sco:p73</p>
<p>type</p>	<p>p73:Cred_Imp_Estero_Type</p>
<p>children</p>	<p>p73:Anno p73:TotCredito p73:CreditoStato</p>

complexType **Modulo_Terreno_Type**

<p>diagram</p>	
<p>namespace</p>	<p>urn:www.agenziaentrate.gov.it:specificheTecniche:sco:p73</p>
<p>children</p>	<p>p73:Terreno</p>

element **Modulo_Terreno_Type/Terreno**

<p>diagram</p>	
<p>namespace</p>	<p>urn:www.agenziaentrate.gov.it:specificheTecniche:sco:p73</p>
<p>type</p>	<p>p73:Terreno_Type</p>
<p>children</p>	<p>p73:RedDominicale p73:Titolo p73:RedAgrario p73:GiorniPossesso p73:PercPossesso p73:CanoneVincolistico p73:CasiParticolari p73:CasellaContinuazione p73:CasellalmuNonDovuta p73:CasellaColtivatoreDiretto</p>

complexType **N_Rate_Type**

<p>diagram</p>	
<p>namespace</p>	<p>urn:www.agenziaentrate.gov.it:specificheTecniche:sco:p73</p>
<p>children</p>	<p>p73:Rate5 p73:Rate10</p>

element **N_Rate_Type/Rate5**

<p>diagram</p>							
<p>namespace</p>	<p>urn:www.agenziaentrate.gov.it:specificheTecniche:sco:p73</p>						
<p>type</p>	<p>p73:Rate5_Type</p>						
<p>facets</p>	<table border="1"> <thead> <tr> <th>Kind</th> <th>Value</th> </tr> </thead> <tbody> <tr> <td>pattern</td> <td>[1-9]{1}[0-9]*</td> </tr> <tr> <td>enumeration</td> <td>5</td> </tr> </tbody> </table>	Kind	Value	pattern	[1-9]{1}[0-9]*	enumeration	5
Kind	Value						
pattern	[1-9]{1}[0-9]*						
enumeration	5						

element **N_Rate_Type/Rate10**

diagram																									
namespace	urn:www.agenziaentrate.gov.it:specificheTecniche:sco:p73																								
type	p73:Rate10_Type																								
facets	<table border="1"> <thead> <tr> <th>Kind</th> <th>Value</th> </tr> </thead> <tbody> <tr> <td>pattern</td> <td>[1-9]{1}[0-9]*</td> </tr> <tr> <td>enumeration</td> <td>1</td> </tr> <tr> <td>enumeration</td> <td>2</td> </tr> <tr> <td>enumeration</td> <td>3</td> </tr> <tr> <td>enumeration</td> <td>4</td> </tr> <tr> <td>enumeration</td> <td>5</td> </tr> <tr> <td>enumeration</td> <td>6</td> </tr> <tr> <td>enumeration</td> <td>7</td> </tr> <tr> <td>enumeration</td> <td>8</td> </tr> <tr> <td>enumeration</td> <td>9</td> </tr> <tr> <td>enumeration</td> <td>10</td> </tr> </tbody> </table>	Kind	Value	pattern	[1-9]{1}[0-9]*	enumeration	1	enumeration	2	enumeration	3	enumeration	4	enumeration	5	enumeration	6	enumeration	7	enumeration	8	enumeration	9	enumeration	10
Kind	Value																								
pattern	[1-9]{1}[0-9]*																								
enumeration	1																								
enumeration	2																								
enumeration	3																								
enumeration	4																								
enumeration	5																								
enumeration	6																								
enumeration	7																								
enumeration	8																								
enumeration	9																								
enumeration	10																								

complexType **Oneri_Non_Abbattuti_Type**

diagram	
namespace	urn:www.agenziaentrate.gov.it:specificheTecniche:sco:p73
children	p73:DetrazSpeseAssPersonale p73:DetrazErogazBiennaleVenezia p73:DetrazErogazSpettacolo p73:DetrazErogazSettoreMusicale p73:DeduzContributiPaesiSviluppo p73:DeduzOnlus p73:DetrazOspedaleGalliera p73:PrevidenzaComplDipPubblici p73:InteressiMutuiAgrari

element **Oneri_Non_Abbattuti_Type/DetrazSpeseAssPersonale**

diagram	
namespace	urn:www.agenziaentrate.gov.it:specificheTecniche:sco:p73

type	DatoNP_Type
facets	Kind Value pattern [1-9]{1}[0-9]*

element Oneri_Non_Abbattuti_Type/DetrazErogazBiennaleVenezia

diagram	
namespace	urn:www.agenziaentrate.gov.it:specificheTecniche:sco:p73
type	DatoNP_Type
facets	Kind Value pattern [1-9]{1}[0-9]*

element Oneri_Non_Abbattuti_Type/DetrazErogazSpettacolo

diagram	
namespace	urn:www.agenziaentrate.gov.it:specificheTecniche:sco:p73
type	DatoNP_Type
facets	Kind Value pattern [1-9]{1}[0-9]*

element Oneri_Non_Abbattuti_Type/DetrazErogazSettoreMusicale

diagram	
namespace	urn:www.agenziaentrate.gov.it:specificheTecniche:sco:p73
type	DatoNP_Type
facets	Kind Value pattern [1-9]{1}[0-9]*

element Oneri_Non_Abbattuti_Type/DeduzContributiPaesiSviluppo

diagram	
namespace	urn:www.agenziaentrate.gov.it:specificheTecniche:sco:p73
type	DatoNP_Type
facets	Kind Value pattern [1-9]{1}[0-9]*

element Oneri_Non_Abbattuti_Type/DeduzOnlus

diagram	
namespace	urn:www.agenziaentrate.gov.it:specificheTecniche:sco:p73

type	DatoNP_Type
facets	Kind Value pattern [1-9]{1}[0-9]*

element Oneri_Non_Abbattuti_Type/DetrazOspedaleGalliera

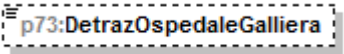
diagram	
namespace	urn:www.agenziaentrate.gov.it:specificheTecniche:sco:p73
type	DatoNP_Type
facets	Kind Value pattern [1-9]{1}[0-9]*

element Oneri_Non_Abbattuti_Type/PrevidenzaCompIDipPubblici

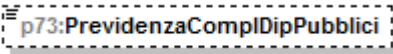
diagram	
namespace	urn:www.agenziaentrate.gov.it:specificheTecniche:sco:p73
type	DatoNP_Type
facets	Kind Value pattern [1-9]{1}[0-9]*

element Oneri_Non_Abbattuti_Type/InteressiMutuiAgrari

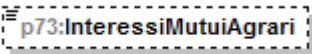
diagram	
namespace	urn:www.agenziaentrate.gov.it:specificheTecniche:sco:p73
type	DatoNP_Type
facets	Kind Value pattern [1-9]{1}[0-9]*

complexType Oneri_Type

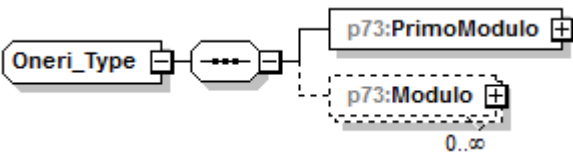
diagram	
namespace	urn:www.agenziaentrate.gov.it:specificheTecniche:sco:p73
children	p73:PrimoModulo p73:Modulo

element **Oneri_Type/PrimoModulo**

<p>diagram</p>	<p>The diagram illustrates the structure of the <code>p73:PrimoModulo</code> class. It is composed of several sub-elements, each represented by a dashed-line box with a plus sign icon. The sub-elements and their cardinalities are:</p> <ul style="list-style-type: none"> <code>p73:SpeseDetrazioni</code> (no cardinality shown) <code>p73:SpeseDeduzioni</code> (no cardinality shown) <code>p73:InterventoRecuperoPatrim...</code> with a cardinality of <code>0..4</code> <code>p73:DatiCatastaliRecuperoPatri...</code> (no cardinality shown) <code>p73:InterventoRisparmioEnerg...</code> with a cardinality of <code>0..3</code> <code>p73:CanoniLocazione</code> (no cardinality shown) <code>p73:DatiAltreDetrazioni</code> (no cardinality shown) <code>p73:OneriNonAbbattuti</code> (no cardinality shown) <code>p73:SpeseArredo</code> with a cardinality of <code>0..2</code> <p>The <code>p73:PrimoModulo</code> class is connected to a central connector box, which in turn connects to each of these sub-element boxes.</p>
<p>namespace</p>	<p>urn:www.agenziaentrate.gov.it:specificheTecniche:sco:p73</p>
<p>type</p>	<p>p73:Primo_Modulo_Oneri_Type</p>
<p>children</p>	<p>p73:SpeseDetrazioni p73:SpeseDeduzioni p73:InterventoRecuperoPatrimonioEdilizio p73:DatiCatastaliRecuperoPatrimonioEdilizio p73:InterventoRisparmioEnergetico p73:CanoniLocazione p73:DatiAltreDetrazioni p73:OneriNonAbbattuti p73:SpeseArredo</p>

element **Oneri_Type/Modulo**

<p>diagram</p>	
<p>namespace</p>	<p>urn:www.agenziaentrate.gov.it:specificheTecniche:sco:p73</p>
<p>type</p>	<p>p73:Modulo Oneri Type</p>
<p>children</p>	<p>p73:SpeseDetrazioni p73:SpeseDeduzioni p73:InterventoRecuperoPatrimonioEdilizio p73:DatiCatastaliRecuperoPatrimonioEdilizio p73:InterventoRisparmioEnergetico p73:CanoniLocazione p73:DatiAltreDetrazioni p73:SpeseArredo</p>

complexType **Opzione_Produttivita_Type**

<p>diagram</p>	
<p>namespace</p>	<p>urn:www.agenziaentrate.gov.it:specificheTecniche:sco:p73</p>

complexType **Periodo_Di_Lavoro_Type**

<p>diagram</p>	
<p>namespace</p>	<p>urn:www.agenziaentrate.gov.it:specificheTecniche:sco:p73</p>
<p>children</p>	<p>p73:GiorniLavoroDipendente p73:GiorniPensione</p>

element **Periodo_Di_Lavoro_Type/GiorniLavoroDipendente**

diagram	
namespace	urn:www.agenziaentrate.gov.it:specificheTecniche:sco:p73
type	DatoGA_Type
facets	Kind Value pattern [1-9](((1-9)[0-9]) ((12)[0-9][0-9]) (3[0-5][0-9]) (36[0-5]))

element **Periodo_Di_Lavoro_Type/GiorniPensione**

diagram	
namespace	urn:www.agenziaentrate.gov.it:specificheTecniche:sco:p73
type	DatoGA_Type
facets	Kind Value pattern [1-9](((1-9)[0-9]) ((12)[0-9][0-9]) (3[0-5][0-9]) (36[0-5]))

complexType **Primo_Modulo_Acconti_Ritenute_Type**

diagram	
namespace	urn:www.agenziaentrate.gov.it:specificheTecniche:sco:p73
children	p73:Accontilrpef p73:AltreRitenute p73:Eccedenze p73:RitenuteAccontiSospesi p73:MisuraAcconti p73:EsenzioneAddComunale p73:Dati730Integrativo p73:AccontiAltriDati

element **Primo_Modulo_Acconti_Ritenute_Type/Accontilrpef**

<p>diagram</p>	
<p>namespace</p>	<p>urn:www.agenziaentrate.gov.it:specificheTecniche:sco:p73</p>
<p>type</p>	<p>p73:Acconti_Irpef_Anno_Imposta_Type</p>
<p>children</p>	<p>p73:PrimaRataAccontolrpef p73:SecondaRataAccontolrpef p73:AccontoAddComunale p73:AccontoAddComunaleF24 p73:PrimaRataAccontoCedolare p73:SecondaRataAccontoCedolare</p>

element **Primo_Modulo_Acconti_Ritenute_Type/AltreRitenute**

<p>diagram</p>	
<p>namespace</p>	<p>urn:www.agenziaentrate.gov.it:specificheTecniche:sco:p73</p>
<p>type</p>	<p>p73:Altre_Ritenute_Type</p>
<p>children</p>	<p>p73:AltreRitenutelrpef p73:AddizionaleRegionale p73:AddizionaleComunale p73:AddRegionaleIrpefAttivitaSport p73:AddComunaleIrpefAttivitaSport p73:IrpefLavoriSocialmenteUtili p73:AddRegionaleIrpefLavoriSocialmenteUtili</p>

element **Primo_Modulo_Acconti_Ritenute_Type/Eccedenze**

<p>diagram</p>	
<p>namespace</p>	<p>urn:www.agenziaentrate.gov.it:specificheTecniche:sco:p73</p>
<p>type</p>	<p>p73:Eccedenze_Type</p>
<p>children</p>	<p>p73:lrpef p73:lrpefCompF24 p73:SostitutivaQuadroRT p73:SostitutivaQuadroRTcompF24 p73:CedolareSecca p73:CedolareSeccaCompF24 p73:CodiceRegione p73:AddRegionalelrpef p73:AddRegionalelrpefCompF24 p73:CodiceCatastaleComune p73:AddComunalelrpef p73:AddComunalelrpefF24</p>

element **Primo_Modulo_Acconti_Ritenute_Type/RitenuteAccontiSospesi**

diagram	
namespace	urn:www.agenziaentrate.gov.it:specificheTecniche:sco:p73
type	p73:Ritenute_Acconti_Sospesi_Type
children	p73:CodiceEvento p73:Irpef p73:AddRegionaleIrpef p73:AddComunaleIrpef p73:CedolareSecca p73:ContribSolidarieta

element **Primo_Modulo_Acconti_Ritenute_Type/MisuraAcconti**

diagram	
namespace	urn:www.agenziaentrate.gov.it:specificheTecniche:sco:p73
type	p73:Misura_Acconti_Type
children	p73:IrpefMisuralInferiore p73:AddComunaleMisuralInferiore p73:CedolareSeccaMisuralInferiore p73:NumeroRate

element **Primo_Modulo_Acconti_Ritenute_Type/EsenzioneAddComunale**

diagram	
---------	--

namespace	urn:www.agenziaentrate.gov.it:specificheTecniche:sco:p73
type	p73:Esenzione_Add_Comunale_Type
children	p73:SogliaEsenzioneSaldo p73:SogliaEsenzioneAcconto

element **Primo_Modulo_Acconti_Ritenute_Type/Dati730Integrativo**

diagram	
namespace	urn:www.agenziaentrate.gov.it:specificheTecniche:sco:p73
type	p73:Dati_730_Integrativo_Type
children	p73:Rimborso p73:Credito

element **Primo_Modulo_Acconti_Ritenute_Type/AccontiAltriDati**

diagram	
namespace	urn:www.agenziaentrate.gov.it:specificheTecniche:sco:p73
type	p73:Acconti_Altri_Dati_Type
children	p73:IncapientiDetrazioneFigli p73:IncapientiDetrazioneLocazione p73:RestituzioneBonusFiscale p73:RestituzioneBonusStraordinario p73:Pignoramento

complexType **Primo_Modulo_Crediti_Imposta_Type**

<p>diagram</p>	
<p>namespace</p>	<p>urn:www.agenziaentrate.gov.it:specificheTecniche:sco:p73</p>
<p>children</p>	<p>p73:CreditoImpostaFabbricati p73:CreditoImpostaFondiPensione p73:CreditoImpostaRedditiEsteri p73:CreditoPrimaCasaSismaAbruzzo p73:CreditoAltriSismaAbruzzo p73:CreditoIncrementoOccupazione p73:CreditoImpostaMediazioni p73:CreditoErogazioniCultura p73:CreditoNegoziazione</p>

element **Primo_Modulo_Crediti_Imposta_Type/CreditoImpostaFabbricati**

<p>diagram</p>	
<p>namespace</p>	<p>urn:www.agenziaentrate.gov.it:specificheTecniche:sco:p73</p>
<p>type</p>	<p>p73:Credito_Imposta_Fabbricati_Type</p>
<p>children</p>	<p>p73:ResiduoFabbricati p73:CanoniLocazioneNonPercepiti</p>

element **Primo_Modulo_Crediti_Imposta_Type/CreditiImpostaFondiPensione**

diagram	
namespace	urn:www.agenziaentrate.gov.it:specificheTecniche:sco:p73
type	extension of p73:Crediti_Imposta_Fondi_Pensione_Type
children	p73:AnnoAnticipazione p73:Reintegro p73:SommaReintegrata p73:CreditoAnno p73:ResiduoPrecedenteDichiarazione p73:DiCuiCompensatoF24

element **Primo_Modulo_Crediti_Imposta_Type/CreditiImpostaFondiPensione/ResiduoPrecedenteDichiarazione**

diagram					
namespace	urn:www.agenziaentrate.gov.it:specificheTecniche:sco:p73				
type	DatoNP_Type				
facets	<table border="1"> <thead> <tr> <th>Kind</th> <th>Value</th> </tr> </thead> <tbody> <tr> <td>pattern</td> <td>[1-9]{1}[0-9]*</td> </tr> </tbody> </table>	Kind	Value	pattern	[1-9]{1}[0-9]*
Kind	Value				
pattern	[1-9]{1}[0-9]*				

element **Primo_Modulo_Crediti_Imposta_Type/CreditiImpostaFondiPensione/DiCuiCompensatoF24**

diagram					
namespace	urn:www.agenziaentrate.gov.it:specificheTecniche:sco:p73				
type	DatoNP_Type				
facets	<table border="1"> <thead> <tr> <th>Kind</th> <th>Value</th> </tr> </thead> <tbody> <tr> <td>pattern</td> <td>[1-9]{1}[0-9]*</td> </tr> </tbody> </table>	Kind	Value	pattern	[1-9]{1}[0-9]*
Kind	Value				
pattern	[1-9]{1}[0-9]*				

element **Primo_Modulo_Crediti_Imposta_Type/CreditiImpostaRedditiEsteri**

<p>diagram</p>	
<p>namespace</p>	<p>urn:www.agenziaentrate.gov.it:specificheTecniche:sco:p73</p>
<p>type</p>	<p>p73:Crediti_Imposta_Redditi_Esteri_Type</p>
<p>children</p>	<p>p73:StatoEstero p73:Anno p73:RedditoEstero p73:ImpostaEstera p73:RedditoComplessivo p73:Imposta_Lorda p73:ImpostaNetta p73:CreditoDichiarazioniPrecedenti p73:DiCuiStatoEstero</p>

element **Primo_Modulo_Crediti_Imposta_Type/CreditoPrimaCasaSismaAbruzzo**

<p>diagram</p>	
<p>namespace</p>	<p>urn:www.agenziaentrate.gov.it:specificheTecniche:sco:p73</p>
<p>type</p>	<p>extension of p73:Credito_Immobile_Sisma_Abruzzo_Type</p>
<p>children</p>	<p>p73:CodiceFiscale p73:NumeroRata p73:TotaleCredito p73:ResiduoPrecedenteDichiarazione</p>

element

Primo_Modulo_Crediti_Imposta_Type/CreditoPrimaCasaSismaAbruzzo/ResiduoPrecedenteDichiarazione

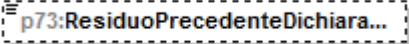
diagram	
namespace	urn:www.agenziaentrate.gov.it:specificheTecniche:sco:p73
type	DatoNP_Type
facets	Kind Value pattern [1-9]{1}[0-9]*

Primo_Modulo_Crediti_Imposta_Type/CreditoAltriSismaAbruzzo

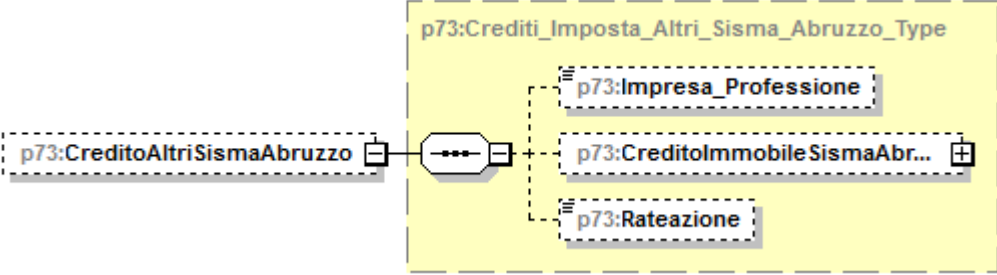
diagram	
namespace	urn:www.agenziaentrate.gov.it:specificheTecniche:sco:p73
type	p73:Crediti_Imposta_Altri_Sisma_Abruzzo_Type
children	p73:Impresa_Professione p73:CreditoImmobileSismaAbruzzo p73:Rateazione

Primo_Modulo_Crediti_Imposta_Type/CreditoIncrementoOccupazione

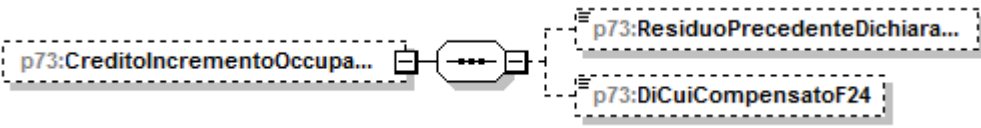
diagram	
namespace	urn:www.agenziaentrate.gov.it:specificheTecniche:sco:p73
children	p73:ResiduoPrecedenteDichiarazione p73:DiCuiCompensatoF24

element

Primo_Modulo_Crediti_Imposta_Type/CreditoIncrementoOccupazione/ResiduoPrecedenteDichiarazione

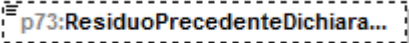
diagram	
namespace	urn:www.agenziaentrate.gov.it:specificheTecniche:sco:p73
type	DatoNP_Type
facets	Kind Value pattern [1-9]{1}[0-9]*

element **Primo_Modulo_Crediti_Imposta_Type/CreditoIncrementoOccupazione/DiCuiCompensatoF24**

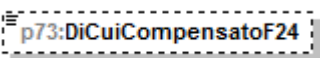
diagram					
namespace	urn:www.agenziaentrate.gov.it:specificheTecniche:sco:p73				
type	DatoNP_Type				
facets	<table border="1"> <thead> <tr> <th>Kind</th> <th>Value</th> </tr> </thead> <tbody> <tr> <td>pattern</td> <td>[1-9]{1}[0-9]*</td> </tr> </tbody> </table>	Kind	Value	pattern	[1-9]{1}[0-9]*
Kind	Value				
pattern	[1-9]{1}[0-9]*				

element **Primo_Modulo_Crediti_Imposta_Type/CreditoImpostaMediazioni**

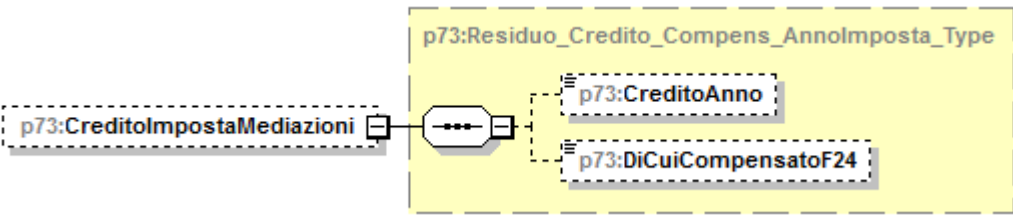
diagram	
namespace	urn:www.agenziaentrate.gov.it:specificheTecniche:sco:p73
type	p73:Residuo_Credito_Compens_AnnoImposta_Type
children	p73:CreditoAnno p73:DiCuiCompensatoF24

element **Primo_Modulo_Crediti_Imposta_Type/CreditoErogazioniCultura**

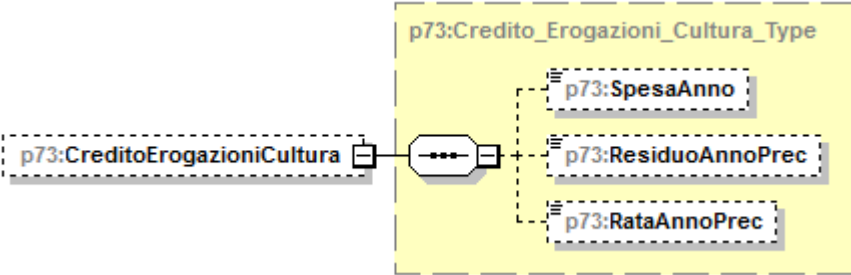
diagram	
namespace	urn:www.agenziaentrate.gov.it:specificheTecniche:sco:p73
type	p73:Credito_Erogazioni_Cultura_Type
children	p73:SpesaAnno p73:ResiduoAnnoPrec p73:RataAnnoPrec

element **Primo_Modulo_Crediti_Imposta_Type/CreditoNegoziazione**

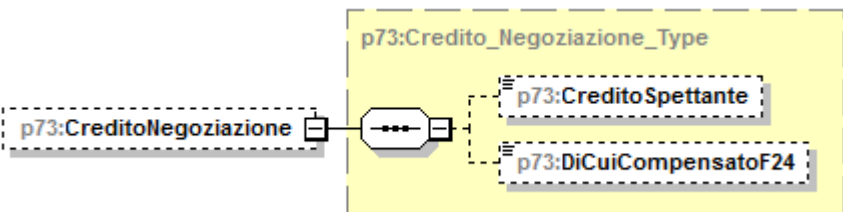
diagram	
---------	--

namespace	urn:www.agenziaentrate.gov.it:specificheTecniche:sco:p73
type	p73:Credito_Negoziazione_Type
children	p73:CreditoSpettante p73:DiCuiCompensatoF24

complexType Primo_Modulo_Familiari_Type

diagram	
namespace	urn:www.agenziaentrate.gov.it:specificheTecniche:sco:p73
type	extension of p73:Modulo_Familiari_Type
children	p73:Coniuge p73:PrimoFiglio p73:Familiari p73:PercUlteriore p73:FigliAffidoPread

element Primo_Modulo_Familiari_Type/PercUlteriore

diagram					
namespace	urn:www.agenziaentrate.gov.it:specificheTecniche:sco:p73				
type	DatoPC_Type				
facets	<table border="1"> <thead> <tr> <th>Kind</th> <th>Value</th> </tr> </thead> <tbody> <tr> <td>pattern</td> <td>[0-9]?[0-9](, d{1,3})? 100,0{1,3}?</td> </tr> </tbody> </table>	Kind	Value	pattern	[0-9]?[0-9](, d{1,3})? 100,0{1,3}?
Kind	Value				
pattern	[0-9]?[0-9](, d{1,3})? 100,0{1,3}?				

element Primo_Modulo_Familiari_Type/FigliAffidoPread

diagram					
namespace	urn:www.agenziaentrate.gov.it:specificheTecniche:sco:p73				
type	DatoNP_Type				
facets	<table border="1"> <thead> <tr> <th>Kind</th> <th>Value</th> </tr> </thead> <tbody> <tr> <td>pattern</td> <td>[1-9]{1}[0-9]*</td> </tr> </tbody> </table>	Kind	Value	pattern	[1-9]{1}[0-9]*
Kind	Value				
pattern	[1-9]{1}[0-9]*				

complexType **Primo_Modulo_Lavoro_Dip_Type**

<p>diagram</p>	
<p>namespace</p>	<p>urn:www.agenziaentrate.gov.it:specificheTecniche:sco:p73</p>
<p>children</p>	<p>p73:LavoroDipendente p73:PeriodoLavoro p73:AltriRedditiAssLavDip p73:RitenuteLavoroDipendente p73:BonusIrpef p73:RedditoAlNettoContribPensioni p73:ContribSolidarietaTrattenuto p73:CasellaCasiParticolari</p>

element **Primo_Modulo_Lavoro_Dip_Type/LavoroDipendente**

<p>diagram</p>	
<p>namespace</p>	<p>urn:www.agenziaentrate.gov.it:specificheTecniche:sco:p73</p>
<p>type</p>	<p>p73:Lavoro Dipendente Type</p>
<p>children</p>	<p>p73:TipologiaReddito p73:TipoContratto p73:Reddito</p>

element **Primo_Modulo_Lavoro_Dip_Type/PeriodoLavoro**

<p>diagram</p>	
----------------	--

namespace	urn:www.agenziaentrate.gov.it:specificheTecniche:sco:p73
type	p73:Periodo Di Lavoro Type
children	p73:GiorniLavoroDipendente p73:GiorniPensione

element **Primo Modulo Lavoro Dip Type/AltriRedditiAssLavDip**

diagram	<pre> classDiagram class p73AltriRedditiAssLavDip { 0..3 } class p73Altri_Redditi_Ass_Lav_Type { p73AssegnoDelConiuge p73ImportoRedditoAssimilato } p73AltriRedditiAssLavDip -- p73Altri_Redditi_Ass_Lav_Type </pre>
namespace	urn:www.agenziaentrate.gov.it:specificheTecniche:sco:p73
type	p73:Altri_Redditi_Ass_Lav_Type
children	p73:AssegnoDelConiuge p73:ImportoRedditoAssimilato

element **Primo Modulo Lavoro Dip Type/RitenuteLavoroDipendente**

diagram	<pre> classDiagram class p73RitenuteLavoroDipendente { } class p73Ritenute_Lavoro_Dip_Type { p73Ritlrpef p73RitAddRegionale p73RitAccAddComunale p73RitSaldoAddComunale p73RitAccAddComAnnoPres } p73RitenuteLavoroDipendente -- p73Ritenute_Lavoro_Dip_Type </pre>
namespace	urn:www.agenziaentrate.gov.it:specificheTecniche:sco:p73
type	p73:Ritenute_Lavoro_Dip_Type
children	p73:Ritlrpef p73:RitAddRegionale p73:RitAccAddComunale p73:RitSaldoAddComunale p73:RitAccAddComAnnoPres

element **Primo_Modulo_Lavoro_Dip_Type/BonusIrpef**

diagram	
namespace	urn:www.agenziaentrate.gov.it:specificheTecniche:sco:p73
type	p73:Bonus_Irpef_Type
children	p73:CodiceBonus p73:BonusErogato p73:Esenzione p73:QuotaTfr

element **Primo_Modulo_Lavoro_Dip_Type/RedditoAlNettoContribPensioni**

diagram					
namespace	urn:www.agenziaentrate.gov.it:specificheTecniche:sco:p73				
type	DatoNP_Type				
facets	<table border="1"> <thead> <tr> <th>Kind</th> <th>Value</th> </tr> </thead> <tbody> <tr> <td>pattern</td> <td>[1-9]{1}[0-9]*</td> </tr> </tbody> </table>	Kind	Value	pattern	[1-9]{1}[0-9]*
Kind	Value				
pattern	[1-9]{1}[0-9]*				

element **Primo_Modulo_Lavoro_Dip_Type/ContribSolidarietaTrattenuto**

diagram					
namespace	urn:www.agenziaentrate.gov.it:specificheTecniche:sco:p73				
type	DatoNP_Type				
facets	<table border="1"> <thead> <tr> <th>Kind</th> <th>Value</th> </tr> </thead> <tbody> <tr> <td>pattern</td> <td>[1-9]{1}[0-9]*</td> </tr> </tbody> </table>	Kind	Value	pattern	[1-9]{1}[0-9]*
Kind	Value				
pattern	[1-9]{1}[0-9]*				

element **Primo_Modulo_Lavoro_Dip_Type/CasellaCasiParticolari**

diagram											
namespace	urn:www.agenziaentrate.gov.it:specificheTecniche:sco:p73										
type	restriction of DatoN1_Type										
facets	<table border="1"> <thead> <tr> <th>Kind</th> <th>Value</th> </tr> </thead> <tbody> <tr> <td>pattern</td> <td>[1-9]</td> </tr> <tr> <td>enumeration</td> <td>1</td> </tr> <tr> <td>enumeration</td> <td>2</td> </tr> <tr> <td>enumeration</td> <td>3</td> </tr> </tbody> </table>	Kind	Value	pattern	[1-9]	enumeration	1	enumeration	2	enumeration	3
Kind	Value										
pattern	[1-9]										
enumeration	1										
enumeration	2										
enumeration	3										

complexType **Primo_Modulo_Oneri_Type**

<p>diagram</p>	
<p>namespace</p>	<p>urn:www.agenziaentrate.gov.it:specificheTecniche:sco:p73</p>
<p>children</p>	<p>p73:SpeseDetrazioni p73:SpeseDeduzioni p73:InterventoRecuperoPatrimonioEdilizio p73:DatiCatastaliRecuperoPatrimonioEdilizio p73:InterventoRisparmioEnergetico p73:CanoniLocazione p73:DatiAltreDetrazioni p73:OneriNonAbbattuti p73:SpeseArredo</p>

element **Primo_Modulo_Oneri_Type/SpeseDetrazioni**

<p>diagram</p>	
<p>namespace</p>	<p>urn:www.agenziaentrate.gov.it:specificheTecniche:sco:p73</p>
<p>type</p>	<p>p73:Detrazioni_Type</p>
<p>children</p>	<p>p73:CasellaRateazione p73:SpeseDeterminatePatologie p73:SpeseSanitarie p73:SpeseFamNonACarico p73:SpeseSanitarieDisabili p73:VeicoliDisabili p73:AcquistoCaniGuida p73:SpeseRateizzate p73:MutuiAbPrincipale p73:AltreSpese</p>

element **Primo_Modulo_Oneri_Type/SpeseDeduzioni**

<p>diagram</p>	
<p>namespace</p>	<p>urn:www.agenziaentrate.gov.it:specificheTecniche:sco:p73</p>
<p>type</p>	<p>p73:Deduzioni_Type</p>
<p>children</p>	<p>p73:ContributiPrevAss p73:AssegnoConiuge p73:ContributiColf p73:ErogazioniIstituzioniReligiose p73:SpesePortatoriHandicap p73:AltriOneri p73:DeducibilitaOrdinaria p73:LavoratoriPrimaOccupazione p73:FondiInSquilibrioFinanziario p73:FamiliariACarico p73:FondoPensioneDipendentiPubblici p73:AcquistoCostruzioneAbitLocazione p73:RestituzioneSomme</p>

element **Primo_Modulo_Oneri_Type/InterventoRecuperoPatrimonioEdilizio**

<p>diagram</p>	
<p>namespace</p>	<p>urn:www.agenziaentrate.gov.it:specificheTecniche:sco:p73</p>
<p>type</p>	<p>p73:Intervento_Recupero_Patrimonio_Edilizio_Type</p>
<p>children</p>	<p>p73:Anno p73:Periodo p73:CodiceFiscale p73:CasellaInterventiParticolari p73:CodiceSituazioniParticolari p73:AnnoSituazioniParticolari p73:RideterminazioneRate p73:NRate p73:Spesa p73:NOrdineImmobile</p>

element **Primo_Modulo_Oneri_Type/DatiCatastaliRecuperoPatrimonioEdilizio**

<p>diagram</p>	
<p>namespace</p>	<p>urn:www.agenziaentrate.gov.it:specificheTecniche:sco:p73</p>
<p>type</p>	<p>p73:Sezione_Dati_Catastali_Recupero_Patrimonio_Edilizio_Type</p>
<p>children</p>	<p>p73:DatiCatastaliRecuperoPatrimonioEdilizio p73:DatiRegistrazioneAccatamentoRecuperoPatrimonio_Edilizio</p>

element **Primo_Modulo_Oneri_Type/InterventoRisparmioEnergetico**

<p>diagram</p>	
<p>namespace</p>	<p>urn:www.agenziaentrate.gov.it:specificheTecniche:sco:p73</p>
<p>type</p>	<p>p73:Intervento Risparmio Energetico Type</p>
<p>children</p>	<p>p73:TipoIntervento p73:Anno p73:Periodo2013 p73:CasiParticolari p73:RideterminazioneRate p73:RipartizioneRate p73:NumeroRata p73:Spesa</p>

element **Primo_Modulo_Oneri_Type/CanoniLocazione**

<p>diagram</p>	
<p>namespace</p>	<p>urn:www.agenziaentrate.gov.it:specificheTecniche:sco:p73</p>
<p>type</p>	<p>p73:Detrazioni Canoni Locazione Type</p>
<p>children</p>	<p>p73:InquiliniAbitazionePrincipale p73:DipendentiTrasferiti</p>

element **Primo_Modulo_Oneri_Type/DatiAltreDetrazioni**

diagram	
namespace	urn:www.agenziaentrate.gov.it:specificheTecniche:sco:p73
type	p73:Dati_Altre_Detrazioni_Type
children	p73:SpeseCaniGuida p73:AffittoTerreniAgricoliGiovani p73:AltreDetrazioni

element **Primo_Modulo_Oneri_Type/OneriNonAbbattuti**

diagram	
namespace	urn:www.agenziaentrate.gov.it:specificheTecniche:sco:p73
type	p73:Oneri_Non_Abbattuti_Type
children	p73:DetrazSpeseAssPersonale p73:DetrazErogazBiennaleVenezia p73:DetrazErogazSpettacolo p73:DetrazErogazSettoreMusicale p73:DeduzContributiPaesiSviluppo p73:DeduzOnlus p73:DetrazOspedaleGalliera p73:PrevidenzaComplDipPubblici p73:InteressiMutuiAgrari

element **Primo_Modulo_Oneri_Type/SpeseArredo**

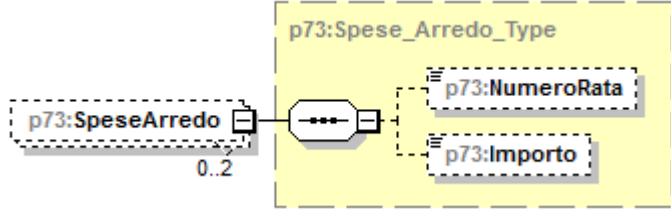
<p>diagram</p>	
<p>namespace</p>	<p>urn:www.agenziaentrate.gov.it:specificheTecniche:sco:p73</p>
<p>type</p>	<p>p73:Spese_Arredo_Type</p>
<p>children</p>	<p>p73:NumeroRata p73:Importo</p>

complexType **Primo_Modulo_PL_Type**

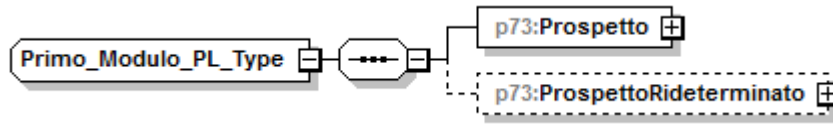
<p>diagram</p>	
<p>namespace</p>	<p>urn:www.agenziaentrate.gov.it:specificheTecniche:sco:p73</p>
<p>children</p>	<p>p73:Prospetto p73:ProspettoRideterminato</p>

element **Primo_Modulo_PL_Type/Prospetto**

<p>diagram</p>	<pre> classDiagram class p73Prospetto_Type["p73:Prospetto_Type (extension)"] class p73Prospetto p73Prospetto_Type .. > p73Prospetto p73Prospetto_Type .. p73RiepilogoRedditi["p73:RiepilogoRedditi"] p73Prospetto_Type .. p73ImpostaLorda["p73:ImpostaLorda"] p73Prospetto_Type .. p73DetrazioniCrediti["p73:DetrazioniCrediti"] p73Prospetto_Type .. p73ImpostaNetta["p73:ImpostaNetta"] p73Prospetto_Type .. p73Addizionali["p73:Addizionali"] p73Prospetto_Type .. p73CedolareSecca["p73:CedolareSecca"] p73Prospetto_Type .. p73ContributoSolidarieta["p73:ContributoSolidarieta"] p73Prospetto_Type .. p73LiquidazioneImposte["p73:LiquidazioneImposte"] p73Prospetto_Type .. p73AltriDati["p73:AltriDati"] p73Prospetto_Type .. p73CredImpEestero["p73:CredImpEestero"] p73Prospetto_Type .. p73DatiCreditiF24["p73:DatiCreditiF24"] </pre>
<p>namespace</p>	<p>urn:www.agenziaentrate.gov.it:specificheTecniche:sco:p73</p>
<p>type</p>	<p>extension of p73:Prospetto_Type</p>
<p>children</p>	<p>p73:RiepilogoRedditi p73:ImpostaLorda p73:DetrazioniCrediti p73:ImpostaNetta p73:Addizionali p73:CedolareSecca p73:ContributoSolidarieta p73:LiquidazioneImposte p73:AltriDati p73:CredImpEestero p73:DatiCreditiF24</p>

element **Primo_Modulo_PL_Type/Prospetto/Addizionali**

<p>diagram</p>	
<p>namespace</p>	<p>urn:www.agenziaentrate.gov.it:specificheTecniche:sco:p73</p>
<p>type</p>	<p>p73:Addizionali_Type</p>
<p>children</p>	<p>p73:Imponibile p73:AddRegDovuta p73:AddRegCertif p73:EccedenzaAddReg p73:AddComDovuta p73:AddComCertif p73:EccedenzaAddCom p73:AccontoAddCom p73:AccontoAddComCertif</p>

element **Primo_Modulo_PL_Type/Prospetto/CedolareSecca**

<p>diagram</p>	
<p>namespace</p>	<p>urn:www.agenziaentrate.gov.it:specificheTecniche:sco:p73</p>
<p>type</p>	<p>p73:Cedolare_Secca_Type</p>
<p>children</p>	<p>p73:CedolareDovuta p73:EccedenzaCedolareSecca p73:AccontoCedolare</p>

element **Primo_Modulo_PL_Type/Prospetto/ContributoSolidarieta**

diagram	
namespace	urn:www.agenziaentrate.gov.it:specificheTecniche:sco:p73
type	p73:Contributo_Solidarieta_Type
children	p73:ImponibileContributo p73:ContributoDovuto p73:ContributoCertificaz

element **Primo_Modulo_PL_Type/Prospetto/LiquidazioneImposte**

diagram	
namespace	urn:www.agenziaentrate.gov.it:specificheTecniche:sco:p73
children	p73:EsitoIrpref p73:EsitoAddRegionale p73:EsitoAddComunale p73:PrimaRataAcclrpref p73:SecondaRataAcclrpref p73:AccontoTassSep p73:AccontoAddComunale p73:EsitoCedolareSecca p73:PrimaRataAccCedolare p73:SecondaRataAccCedolare p73:ContribSolidarietaDebito

element Primo_Modulo_PL_Type/Prospetto/LiquidazioneImposte/EsitoIrpef

diagram	
namespace	urn:www.agenziaentrate.gov.it:specificheTecniche:sco:p73
type	p73:Esito_Liquidazione_Type
children	p73:Credito p73:Debito

element Primo_Modulo_PL_Type/Prospetto/LiquidazioneImposte/EsitoAddRegionale

diagram	
namespace	urn:www.agenziaentrate.gov.it:specificheTecniche:sco:p73
type	extension of p73:Esito_Liquidazione_Type
children	p73:Credito p73:Debito p73:CodAddReg

element Primo_Modulo_PL_Type/Prospetto/LiquidazioneImposte/EsitoAddRegionale/CodAddReg

diagram																																			
namespace	urn:www.agenziaentrate.gov.it:specificheTecniche:sco:p73																																		
type	Codice Regione Type																																		
facets	<table border="1"> <thead> <tr> <th>Kind</th> <th>Value</th> </tr> </thead> <tbody> <tr> <td>pattern</td> <td>([0-9A-Z\-\-] \&quot;){1}([0-9A-Z&amp;]; ' \- \., /° ^\(\\) À È É Ì Ò Ù Û &quot;; \\ / +)*</td> </tr> <tr> <td>enumeration</td> <td>1</td> </tr> <tr> <td>enumeration</td> <td>2</td> </tr> <tr> <td>enumeration</td> <td>3</td> </tr> <tr> <td>enumeration</td> <td>4</td> </tr> <tr> <td>enumeration</td> <td>5</td> </tr> <tr> <td>enumeration</td> <td>6</td> </tr> <tr> <td>enumeration</td> <td>7</td> </tr> <tr> <td>enumeration</td> <td>8</td> </tr> <tr> <td>enumeration</td> <td>9</td> </tr> <tr> <td>enumeration</td> <td>10</td> </tr> <tr> <td>enumeration</td> <td>11</td> </tr> <tr> <td>enumeration</td> <td>12</td> </tr> <tr> <td>enumeration</td> <td>13</td> </tr> <tr> <td>enumeration</td> <td>14</td> </tr> <tr> <td>enumeration</td> <td>15</td> </tr> </tbody> </table>	Kind	Value	pattern	([0-9A-Z\-\-] \"){1}([0-9A-Z&]; ' \- \., /° ^\(\\) À È É Ì Ò Ù Û "; \\ / +)*	enumeration	1	enumeration	2	enumeration	3	enumeration	4	enumeration	5	enumeration	6	enumeration	7	enumeration	8	enumeration	9	enumeration	10	enumeration	11	enumeration	12	enumeration	13	enumeration	14	enumeration	15
Kind	Value																																		
pattern	([0-9A-Z\-\-] \"){1}([0-9A-Z&]; ' \- \., /° ^\(\\) À È É Ì Ò Ù Û "; \\ / +)*																																		
enumeration	1																																		
enumeration	2																																		
enumeration	3																																		
enumeration	4																																		
enumeration	5																																		
enumeration	6																																		
enumeration	7																																		
enumeration	8																																		
enumeration	9																																		
enumeration	10																																		
enumeration	11																																		
enumeration	12																																		
enumeration	13																																		
enumeration	14																																		
enumeration	15																																		

	enumeration 16
	enumeration 17
	enumeration 18
	enumeration 19
	enumeration 20
	enumeration 21

element **Primo_Modulo_PL_Type/Prospetto/LiquidazioneImposte/EsitoAddComunale**

diagram	
namespace	urn:www.agenziaentrate.gov.it:specificheTecniche:sco:p73
type	extension of p73:Esito_Liquidazione_Type
children	p73:Credito p73:Debito p73:CodiceAddCom

element **Primo_Modulo_PL_Type/Prospetto/LiquidazioneImposte/EsitoAddComunale/CodiceAddCom**

diagram					
namespace	urn:www.agenziaentrate.gov.it:specificheTecniche:sco:p73				
type	DatoAN_Type				
facets	<table border="1"> <thead> <tr> <th>Kind</th> <th>Value</th> </tr> </thead> <tbody> <tr> <td>pattern</td> <td>([0-9A-Z\-\]&quot;){1}([0-9A-Z&amp; ; ' - \., / "^\(\)\ À É È Ì Ò Ù Ú &quot; ; \\ / +)*</td> </tr> </tbody> </table>	Kind	Value	pattern	([0-9A-Z\-\]"){1}([0-9A-Z& ; ' - \., / "^\(\)\ À É È Ì Ò Ù Ú " ; \\ / +)*
Kind	Value				
pattern	([0-9A-Z\-\]"){1}([0-9A-Z& ; ' - \., / "^\(\)\ À É È Ì Ò Ù Ú " ; \\ / +)*				

element **Primo_Modulo_PL_Type/Prospetto/LiquidazioneImposte/PrimaRataAcclrpef**

diagram					
namespace	urn:www.agenziaentrate.gov.it:specificheTecniche:sco:p73				
type	DatoNP_Type				
facets	<table border="1"> <thead> <tr> <th>Kind</th> <th>Value</th> </tr> </thead> <tbody> <tr> <td>pattern</td> <td>[1-9]{1}[0-9]*</td> </tr> </tbody> </table>	Kind	Value	pattern	[1-9]{1}[0-9]*
Kind	Value				
pattern	[1-9]{1}[0-9]*				

element **Primo_Modulo_PL_Type/Prospetto/LiquidazioneImposte/SecondaRataAcclrpef**

diagram	
namespace	urn:www.agenziaentrate.gov.it:specificheTecniche:sco:p73
type	DatoNP_Type

facets	Kind pattern	Value [1-9]{1}[0-9]*
--------	-----------------	-------------------------

element **Primo_Modulo_PL_Type/Prospetto/LiquidazioneImposte/AccontoTassSep**

diagram	
namespace	urn:www.agenziaentrate.gov.it:specificheTecniche:sco:p73
type	p73:Debito_Type
children	p73:NonVersare p73:ImportoDaTrattenere

element **Primo_Modulo_PL_Type/Prospetto/LiquidazioneImposte/AccontoAddComunale**

diagram	
namespace	urn:www.agenziaentrate.gov.it:specificheTecniche:sco:p73
children	p73:CodiceAddComAcconto p73:AccontoAddCom

element

Primo_Modulo_PL_Type/Prospetto/LiquidazioneImposte/AccontoAddComunale/CodiceAddComAcconto

diagram		
namespace	urn:www.agenziaentrate.gov.it:specificheTecniche:sco:p73	
type	DatoAN_Type	
facets	Kind pattern	Value ([0-9A-Z\-_]"){1}([0-9A-Z&#39; ! - \., / ° °\(\) À É È Ò Ù Û " \ \ /+)*

element

Primo_Modulo_PL_Type/Prospetto/LiquidazioneImposte/AccontoAddComunale/AccontoAddCom

diagram		
namespace	urn:www.agenziaentrate.gov.it:specificheTecniche:sco:p73	
type	DatoNP_Type	
facets	Kind pattern	Value [1-9]{1}[0-9]*

element **Primo_Modulo_PL_Type/Prospetto/LiquidazioneImposte/EsitoCedolareSecca**

diagram	
namespace	urn:www.agenziaentrate.gov.it:specificheTecniche:sco:p73
type	p73:Esito_Liquidazione_Type
children	p73:Credito p73:Debito

element **Primo_Modulo_PL_Type/Prospetto/LiquidazioneImposte/PrimaRataAccCedolare**

diagram					
namespace	urn:www.agenziaentrate.gov.it:specificheTecniche:sco:p73				
type	DatoNP_Type				
facets	<table border="1"> <thead> <tr> <th>Kind</th> <th>Value</th> </tr> </thead> <tbody> <tr> <td>pattern</td> <td>[1-9]{1}[0-9]*</td> </tr> </tbody> </table>	Kind	Value	pattern	[1-9]{1}[0-9]*
Kind	Value				
pattern	[1-9]{1}[0-9]*				

element **Primo_Modulo_PL_Type/Prospetto/LiquidazioneImposte/SecondaRataAccCedolare**

diagram					
namespace	urn:www.agenziaentrate.gov.it:specificheTecniche:sco:p73				
type	DatoNP_Type				
facets	<table border="1"> <thead> <tr> <th>Kind</th> <th>Value</th> </tr> </thead> <tbody> <tr> <td>pattern</td> <td>[1-9]{1}[0-9]*</td> </tr> </tbody> </table>	Kind	Value	pattern	[1-9]{1}[0-9]*
Kind	Value				
pattern	[1-9]{1}[0-9]*				

element **Primo_Modulo_PL_Type/Prospetto/LiquidazioneImposte/ContribSolidarietaDebito**

diagram	
namespace	urn:www.agenziaentrate.gov.it:specificheTecniche:sco:p73
type	p73:Debito_Type
children	p73:NonVersare p73:ImportoDaTrattenere

element **Primo_Modulo_PL_Type/Prospetto/AltriDati**

<p>diagram</p>	
<p>namespace</p>	<p>urn:www.agenziaentrate.gov.it:specificheTecniche:sco:p73</p>
<p>type</p>	<p>p73:Altri Dati Type</p>
<p>children</p>	<p>p73:ResiduoCreditoErogazioneCultura p73:ResiduoCreditoPrimaCasa p73:ResiduoCreditoOccupazione p73:ResiduoCreditoSisma p73:ResiduoCreditoFondiPensione p73:ResiduoCreditoMediazioni p73:TotSpeseSanitarieRateizzate p73:RedditoAgevolazioniFiscali p73:RedditoComplessivoAcconto p73:RigoDifferenzaAcconto p73:RedditiFondiariniNonImponibili p73:RedditoAbitazionePrincipalePertinenze p73:ResiduoDeduzioneSommeRestituite p73:ResiduoCreditoNegoziazione p73:CreditoErogazioneCultura</p>

element **Primo_Modulo_PL_Type/Prospetto/CredImpEstero**

<p>diagram</p>	
<p>namespace</p>	<p>urn:www.agenziaentrate.gov.it:specificheTecniche:sco:p73</p>
<p>type</p>	<p>p73:Cred_Imp_Estero_Type</p>
<p>children</p>	<p>p73:Anno p73:TotCredito p73:CreditoStato</p>

element **Primo_Modulo_PL_Type/Prospetto/DatiCreditiF24**

<p>diagram</p>	
<p>namespace</p>	<p>urn:www.agenziaentrate.gov.it:specificheTecniche:sco:p73</p>
<p>type</p>	<p>p73:Crediti_F24_Type</p>
<p>children</p>	<p>p73:Credlrpef p73:CredlrpefDipNoSostituto p73:CodAddReg p73:CredAddReg p73:CredAddRegDipNoSostituto p73:CodiceAddCom p73:CredAddCom p73:CredAddComDipNoSostituto p73:CredCedolare p73:CredCedolareDipNoSostituto p73:CredTassSeparDipNoSostituto p73:CredProduttivitaDipNoSostituto p73:CredSolidarietaDipNoSostituto p73:Totale p73:TotaleDipNoSostituto</p>

element **Primo_Modulo_PL_Type/ProspettoRideterminato**

diagram	
namespace	urn:www.agenziaentrate.gov.it:specificheTecniche:sco:p73
type	extension of p73:Prospetto_Type
children	p73:RiepilogoRedditi p73:ImpostaLorda p73:DetrazioniCrediti p73:ImpostaNetta p73:RedditoAgevolazioniFiscali

element **Primo_Modulo_PL_Type/ProspettoRideterminato/RedditoAgevolazioniFiscali**

diagram					
namespace	urn:www.agenziaentrate.gov.it:specificheTecniche:sco:p73				
type	DatoNP_Type				
facets	<table border="1"> <thead> <tr> <th>Kind</th> <th>Value</th> </tr> </thead> <tbody> <tr> <td>pattern</td> <td>[1-9]{1}[0-9]*</td> </tr> </tbody> </table>	Kind	Value	pattern	[1-9]{1}[0-9]*
Kind	Value				
pattern	[1-9]{1}[0-9]*				

complexType **Prospetto_Liquidazione_Type**

diagram	
namespace	urn:www.agenziaentrate.gov.it:specificheTecniche:sco:p73
children	p73:PrimoModulo p73:Modulo

element **Prospetto_Liquidazione_Type/PrimoModulo**

diagram	
---------	--

namespace	urn:www.agenziaentrate.gov.it:specificheTecniche:sco:p73
type	p73:Primo_Modulo_PL_Type
children	p73:Prospetto p73:ProspettoRideterminato

element Prospetto_Liquidazione_Type/Modulo

diagram	
namespace	urn:www.agenziaentrate.gov.it:specificheTecniche:sco:p73
type	p73:Modulo_PL_Type
children	p73:CredImpEstero

complexType Prospetto_Type

diagram	
namespace	urn:www.agenziaentrate.gov.it:specificheTecniche:sco:p73
children	p73:RiepilogoRedditi p73:ImpostaLorda p73:DetrazioniCrediti p73:ImpostaNetta

element **Prospetto_Type/RiepilogoRedditi**

<p>diagram</p>	
<p>namespace</p>	<p>urn:www.agenziaentrate.gov.it:specificheTecniche:sco:p73</p>
<p>type</p>	<p>p73:Riepilogo_Redditi_Type</p>
<p>children</p>	<p>p73:Dominicali p73:Agrari p73:Fabbricati p73:LavDip p73:AltriRedditi p73:ImponibileCedolare p73:ImponibileCedolareOrdinario p73:ImponibileCedolareAgevolato p73:AbitazionePrincipalePertinenze</p>

element **Prospetto_Type/ImpostaLorda**

<p>diagram</p>	
<p>namespace</p>	<p>urn:www.agenziaentrate.gov.it:specificheTecniche:sco:p73</p>
<p>type</p>	<p>p73:Imposta_Lorda_Type</p>
<p>children</p>	<p>p73:RedditoComplessivo p73:DeduzioneAbitazPrincipale p73:OneriDeducibili p73:RedditoImponibile p73:CompensiAttSport p73:ImportoImpostaLorda</p>

element **Prospetto_Type/DetrazioniCrediti**

<p>diagram</p>	
<p>namespace</p>	<p>urn:www.agenziaentrate.gov.it:specificheTecniche:sco:p73</p>
<p>type</p>	<p>p73:Detrazione_Crediti_Type</p>
<p>children</p>	<p>p73:DetrazioneConiuge p73:DetrazioneFigli p73:UlterioreDetrazioneFigli p73:DetrazioneFamiliari p73:DetrazioneLavDip p73:DetrazionePens p73:DetrazioneAltriRedditi p73:DetrazioneOneri p73:DetrazioneRistrutturazione p73:DetrazioniArredolmmobili p73:DetrazioneRisparmioEnergetico p73:DetrazioneLocEAgricoliGiovani p73:AltreDetrazioni p73:CreditoPrimaCasa p73:CreditoOccupazione p73:CreditoFondiPensione p73:CreditoMediazioni p73:CreditoNegoziazione p73:TotaleDetrazioniCrediti</p>

p73:CreditoFondiPensione p73:CreditoMediazioni p73:CreditoNegoziazione p73:TotaleDetrazioniCrediti
--

element **Prospetto_Type/ImpostaNetta**

diagram	
namespace	urn:www.agenziaentrate.gov.it:specificheTecniche:sco:p73
type	p73:Imposta_Netta_Type
children	p73:ImportoImpostaNetta p73:CredAltriSisma p73:CredAbitazSisma p73:CredImpEstere p73:CredErogCultura p73:CredCanNonPerc p73:CredDetrazIncapienti p73:Ritenute p73:Differenza p73:EccedenzaIrpéf p73:AccontiVersati p73:RestituzioneBonus p73:CredRimborsatiSost p73:BonusIrpéfSpettante p73:BonusIrpéfRiconosciuto p73:RestituzioneBonusIrpéf

complexType **Redditi_Capitale_Type**

diagram	
namespace	urn:www.agenziaentrate.gov.it:specificheTecniche:sco:p73
children	p73:Utili p73:AltriRedditiDiCapitale p73:LavoroAutonomo p73:RedditiDiversi p73:RedditiDiversiDetraz

element **Redditi_Capitale_Type/Utili**

diagram	
namespace	urn:www.agenziaentrate.gov.it:specificheTecniche:sco:p73
type	p73:Altri_Redditi_Utili_Type
children	p73:Tipo_Reddito p73:RedditiRitenute

element **Redditi_Capitale_Type/AltriRedditiDiCapitale**

diagram	
namespace	urn:www.agenziaentrate.gov.it:specificheTecniche:sco:p73
type	p73:Sezione_Altri_Redd_Type
children	p73:TipoReddito p73:RedditiRitenute

element **Redditi_Capitale_Type/LavoroAutonomo**

diagram	
namespace	urn:www.agenziaentrate.gov.it:specificheTecniche:sco:p73
type	p73:Altri Redditi Lavoro Autonomo Type
children	p73:TipoReddito p73:RedditiRitenute

element **Redditi_Capitale_Type/RedditiDiversi**

diagram	
namespace	urn:www.agenziaentrate.gov.it:specificheTecniche:sco:p73
type	p73:Altri Redditi Diversi Type
children	p73:TipoReddito p73:RedditiRitenuteSpese

element **Redditi_Capitale_Type/RedditiDiversiDetraz**

diagram	
namespace	urn:www.agenziaentrate.gov.it:specificheTecniche:sco:p73
type	p73:Altri Redditi Diversi Detr Type
children	p73:Tipo_Reddito p73:RedditiRitenuteSpese

complexType **Redditi_Eredi_Legatari_Type**

diagram	
namespace	urn:www.agenziaentrate.gov.it:specificheTecniche:sco:p73
type	extension of p73:Tassazione_Separata_Type
children	p73:Opzione p73:Anno p73:RedditoRitenute p73:TipoReddito p73:RedditoTotale p73:QuotalmposteSuccessioni

element **Redditi_Eredi_Legatari_Type/TipoReddito**

diagram																													
namespace	urn:www.agenziaentrate.gov.it:specificheTecniche:sco:p73																												
type	p73:Tipo_Reddito_Da1a12_Type																												
facets	<table border="1"> <thead> <tr> <th>Kind</th> <th>Value</th> </tr> </thead> <tbody> <tr> <td>pattern</td> <td>[1-9]{1}[0-9]*</td> </tr> <tr> <td>enumeration</td> <td>1</td> </tr> <tr> <td>enumeration</td> <td>2</td> </tr> <tr> <td>enumeration</td> <td>3</td> </tr> <tr> <td>enumeration</td> <td>4</td> </tr> <tr> <td>enumeration</td> <td>5</td> </tr> <tr> <td>enumeration</td> <td>6</td> </tr> <tr> <td>enumeration</td> <td>7</td> </tr> <tr> <td>enumeration</td> <td>8</td> </tr> <tr> <td>enumeration</td> <td>9</td> </tr> <tr> <td>enumeration</td> <td>10</td> </tr> <tr> <td>enumeration</td> <td>11</td> </tr> <tr> <td>enumeration</td> <td>12</td> </tr> </tbody> </table>	Kind	Value	pattern	[1-9]{1}[0-9]*	enumeration	1	enumeration	2	enumeration	3	enumeration	4	enumeration	5	enumeration	6	enumeration	7	enumeration	8	enumeration	9	enumeration	10	enumeration	11	enumeration	12
Kind	Value																												
pattern	[1-9]{1}[0-9]*																												
enumeration	1																												
enumeration	2																												
enumeration	3																												
enumeration	4																												
enumeration	5																												
enumeration	6																												
enumeration	7																												
enumeration	8																												
enumeration	9																												
enumeration	10																												
enumeration	11																												
enumeration	12																												

element **Redditi_Eredi_Legatari_Type/RedditoTotale**

diagram					
namespace	urn:www.agenziaentrate.gov.it:specificheTecniche:sco:p73				
type	DatoNP_Type				
facets	<table border="1"> <thead> <tr> <th>Kind</th> <th>Value</th> </tr> </thead> <tbody> <tr> <td>pattern</td> <td>[1-9]{1}[0-9]*</td> </tr> </tbody> </table>	Kind	Value	pattern	[1-9]{1}[0-9]*
Kind	Value				
pattern	[1-9]{1}[0-9]*				

element **Redditi_Eredi_Legatari_Type/QuotalImposteSuccessioni**

diagram	
namespace	urn:www.agenziaentrate.gov.it:specificheTecniche:sco:p73
type	DatoNP_Type
facets	Kind Value pattern [1-9]{1}[0-9]*

complexType **Redditi_Fabbricati_Type**

diagram	
namespace	urn:www.agenziaentrate.gov.it:specificheTecniche:sco:p73
children	p73:Modulo

element **Redditi_Fabbricati_Type/Modulo**

diagram	
namespace	urn:www.agenziaentrate.gov.it:specificheTecniche:sco:p73
type	p73:Modulo_Fabbricato_Type
children	p73:FabbricatoOrd p73:FabbricatoAgev

complexType **Redditi_Lavoro_Dip_Type**

diagram	
namespace	urn:www.agenziaentrate.gov.it:specificheTecniche:sco:p73
children	p73:PrimoModulo p73:Modulo

element **Redditi_Lavoro_Dip_Type/PrimoModulo**

<p>diagram</p>	
<p>namespace</p>	<p>urn:www.agenziaentrate.gov.it:specificheTecniche:sco:p73</p>
<p>type</p>	<p>p73:Primo_Modulo_Lavoro_Dip_Type</p>
<p>children</p>	<p>p73:LavoroDipendente p73:PeriodoLavoro p73:AltriRedditiAssLavDip p73:RitenuteLavoroDipendente p73:Bonuslrpef p73:RedditoAlNettoContribPensioni p73:ContribSolidarietaTrattenuto p73:CasellaCasiParticolari</p>

element **Redditi_Lavoro_Dip_Type/Modulo**

<p>diagram</p>	
<p>namespace</p>	<p>urn:www.agenziaentrate.gov.it:specificheTecniche:sco:p73</p>
<p>type</p>	<p>p73:Modulo_Lavoro_Dip_Type</p>
<p>children</p>	<p>p73:LavoroDipendente p73:AltriRedditiAssLavDip p73:Bonuslrpef</p>

complexType Redditi_Ritenute_Spese_Type

diagram	
namespace	urn:www.agenziaentrate.gov.it:specificheTecniche:sco:p73
type	extension of p73:Redditi_Ritenute_Type
children	p73:ImportoRedditi p73:ImportoRitenute p73:ImportoSpese

element Redditi_Ritenute_Spese_Type/ImportoSpese

diagram					
namespace	urn:www.agenziaentrate.gov.it:specificheTecniche:sco:p73				
type	DatoNP_Type				
facets	<table border="1"> <tr> <th>Kind</th> <th>Value</th> </tr> <tr> <td>pattern</td> <td>[1-9]{1}[0-9]*</td> </tr> </table>	Kind	Value	pattern	[1-9]{1}[0-9]*
Kind	Value				
pattern	[1-9]{1}[0-9]*				

complexType Redditi_Ritenute_Type

diagram	
namespace	urn:www.agenziaentrate.gov.it:specificheTecniche:sco:p73
children	p73:ImportoRedditi p73:ImportoRitenute

element Redditi_Ritenute_Type/ImportoRedditi

diagram					
namespace	urn:www.agenziaentrate.gov.it:specificheTecniche:sco:p73				
type	DatoNP_Type				
facets	<table border="1"> <tr> <th>Kind</th> <th>Value</th> </tr> <tr> <td>pattern</td> <td>[1-9]{1}[0-9]*</td> </tr> </table>	Kind	Value	pattern	[1-9]{1}[0-9]*
Kind	Value				
pattern	[1-9]{1}[0-9]*				

element **Redditi_Ritenute_Type/ImportoRitenute**

diagram	
namespace	urn:www.agenziaentrate.gov.it:specificheTecniche:sco:p73
type	DatoNP_Type
facets	Kind Value pattern [1-9]{1}[0-9]*

complexType **Redditi_Tassazione_Separata_Type**

diagram	
namespace	urn:www.agenziaentrate.gov.it:specificheTecniche:sco:p73
children	p73:RedditiErede p73:ImposteRimborsate

element **Redditi_Tassazione_Separata_Type/RedditiErede**

diagram	
namespace	urn:www.agenziaentrate.gov.it:specificheTecniche:sco:p73
type	p73:Redditi_Eredi_Legatari_Type
children	p73:Opzione p73:Anno p73:RedditoRitenute p73:TipoReddito p73:RedditoTotale p73:QuotaImposteSuccessioni

element **Redditi_Tassazione_Separata_Type/ImposteRimborsate**

diagram	
namespace	urn:www.agenziaentrate.gov.it:specificheTecniche:sco:p73
type	p73:Imposte_Rimborsate_Type
children	p73:TipoReddito p73:TassazioneSeparata

complexType **Redditi_Terreni_Type**

diagram	
namespace	urn:www.agenziaentrate.gov.it:specificheTecniche:sco:p73
children	p73:Modulo

element **Redditi_Terreni_Type/Modulo**

diagram	
namespace	urn:www.agenziaentrate.gov.it:specificheTecniche:sco:p73
type	p73:Modulo_Terreno_Type
children	p73:Terreno

complexType **Reddito_Erede_Type**

diagram	
namespace	urn:www.agenziaentrate.gov.it:specificheTecniche:sco:p73
type	extension of p73:Tassazione_Separata_Type

children	p73:Opzione p73:Anno p73:RedditoRitenute
----------	--

complexType Residuo_Credito_Compens_AnnoImposta_Type

diagram	
namespace	urn:www.agenziaentrate.gov.it:specificheTecniche:sco:p73
type	extension of p73:Residuo_Credito_Compens_Type
children	p73:CreditoAnno p73:DiCuiCompensatoF24

complexType Residuo_Credito_Compens_Type

diagram	
namespace	urn:www.agenziaentrate.gov.it:specificheTecniche:sco:p73
children	p73:CreditoAnno p73:DiCuiCompensatoF24

element Residuo_Credito_Compens_Type/CreditoAnno

diagram					
namespace	urn:www.agenziaentrate.gov.it:specificheTecniche:sco:p73				
type	DatoNP_Type				
facets	<table border="1"> <tr> <td>Kind</td> <td>Value</td> </tr> <tr> <td>pattern</td> <td>[1-9]{1}[0-9]*</td> </tr> </table>	Kind	Value	pattern	[1-9]{1}[0-9]*
Kind	Value				
pattern	[1-9]{1}[0-9]*				

element Residuo_Credito_Compens_Type/DiCuiCompensatoF24

diagram					
namespace	urn:www.agenziaentrate.gov.it:specificheTecniche:sco:p73				
type	DatoNP_Type				
facets	<table border="1"> <tr> <td>Kind</td> <td>Value</td> </tr> <tr> <td>pattern</td> <td>[1-9]{1}[0-9]*</td> </tr> </table>	Kind	Value	pattern	[1-9]{1}[0-9]*
Kind	Value				
pattern	[1-9]{1}[0-9]*				

complexType Residuo_Fabbricati_Type

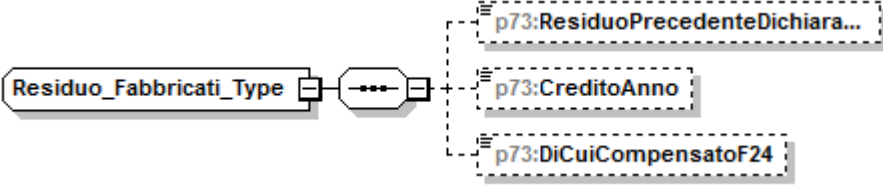
diagram	
namespace	urn:www.agenziaentrate.gov.it:specificheTecniche:sco:p73
children	p73:ResiduoPrecedenteDichiarazione p73:CreditoAnno p73:DiCuiCompensatoF24

element Residuo_Fabbricati_Type/ResiduoPrecedenteDichiarazione

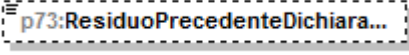
diagram					
namespace	urn:www.agenziaentrate.gov.it:specificheTecniche:sco:p73				
type	DatoNP_Type				
facets	<table border="1"> <tr> <td>Kind</td> <td>Value</td> </tr> <tr> <td>pattern</td> <td>[1-9]{1}[0-9]*</td> </tr> </table>	Kind	Value	pattern	[1-9]{1}[0-9]*
Kind	Value				
pattern	[1-9]{1}[0-9]*				

element Residuo_Fabbricati_Type/CreditoAnno

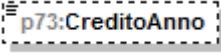
diagram					
namespace	urn:www.agenziaentrate.gov.it:specificheTecniche:sco:p73				
type	DatoNP_Type				
facets	<table border="1"> <tr> <td>Kind</td> <td>Value</td> </tr> <tr> <td>pattern</td> <td>[1-9]{1}[0-9]*</td> </tr> </table>	Kind	Value	pattern	[1-9]{1}[0-9]*
Kind	Value				
pattern	[1-9]{1}[0-9]*				

element Residuo_Fabbricati_Type/DiCuiCompensatoF24

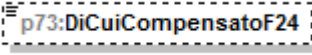
diagram					
namespace	urn:www.agenziaentrate.gov.it:specificheTecniche:sco:p73				
type	DatoNP_Type				
facets	<table border="1"> <tr> <td>Kind</td> <td>Value</td> </tr> <tr> <td>pattern</td> <td>[1-9]{1}[0-9]*</td> </tr> </table>	Kind	Value	pattern	[1-9]{1}[0-9]*
Kind	Value				
pattern	[1-9]{1}[0-9]*				

complexType Restituzione_Somme_Type

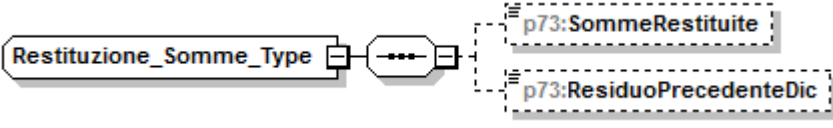
diagram	
namespace	urn:www.agenziaentrate.gov.it:specificheTecniche:sco:p73

children	p73:SommeRestituite p73:ResiduoPrecedenteDic
----------	--

element Restituzione_Somme_Type/SommeRestituite

diagram	
namespace	urn:www.agenziaentrate.gov.it:specificheTecniche:sco:p73
type	DatoNP_Type
facets	Kind Value pattern [1-9]{1}[0-9]*

element Restituzione_Somme_Type/ResiduoPrecedenteDic

diagram	
namespace	urn:www.agenziaentrate.gov.it:specificheTecniche:sco:p73
type	DatoNP_Type
facets	Kind Value pattern [1-9]{1}[0-9]*

complexType Riepilogo_Redditi_Type

diagram	
namespace	urn:www.agenziaentrate.gov.it:specificheTecniche:sco:p73
children	p73:Dominicali p73:Agrari p73:Fabbricati p73:LavDip p73:AltriRedditi p73:ImponibileCedolare p73:ImponibileCedolareOrdinario p73:ImponibileCedolareAgevolato p73:AbitazionePrincipalePertinenze

element Riepilogo_Reddito_Type/Dominicali

diagram					
namespace	urn:www.agenziaentrate.gov.it:specificheTecniche:sco:p73				
type	DatoNP_Type				
facets	<table border="1"> <tr> <td>Kind</td> <td>Value</td> </tr> <tr> <td>pattern</td> <td>[1-9]{1}[0-9]*</td> </tr> </table>	Kind	Value	pattern	[1-9]{1}[0-9]*
Kind	Value				
pattern	[1-9]{1}[0-9]*				

element Riepilogo_Reddito_Type/Agrari

diagram					
namespace	urn:www.agenziaentrate.gov.it:specificheTecniche:sco:p73				
type	DatoNP_Type				
facets	<table border="1"> <tr> <td>Kind</td> <td>Value</td> </tr> <tr> <td>pattern</td> <td>[1-9]{1}[0-9]*</td> </tr> </table>	Kind	Value	pattern	[1-9]{1}[0-9]*
Kind	Value				
pattern	[1-9]{1}[0-9]*				

element Riepilogo_Reddito_Type/Fabbricati

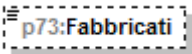
diagram					
namespace	urn:www.agenziaentrate.gov.it:specificheTecniche:sco:p73				
type	DatoNP_Type				
facets	<table border="1"> <tr> <td>Kind</td> <td>Value</td> </tr> <tr> <td>pattern</td> <td>[1-9]{1}[0-9]*</td> </tr> </table>	Kind	Value	pattern	[1-9]{1}[0-9]*
Kind	Value				
pattern	[1-9]{1}[0-9]*				

element Riepilogo_Reddito_Type/LavDip

diagram					
namespace	urn:www.agenziaentrate.gov.it:specificheTecniche:sco:p73				
type	DatoNP_Type				
facets	<table border="1"> <tr> <td>Kind</td> <td>Value</td> </tr> <tr> <td>pattern</td> <td>[1-9]{1}[0-9]*</td> </tr> </table>	Kind	Value	pattern	[1-9]{1}[0-9]*
Kind	Value				
pattern	[1-9]{1}[0-9]*				

element Riepilogo_Reddito_Type/AltriRedditi

diagram					
namespace	urn:www.agenziaentrate.gov.it:specificheTecniche:sco:p73				
type	DatoNP_Type				
facets	<table border="1"> <tr> <td>Kind</td> <td>Value</td> </tr> <tr> <td>pattern</td> <td>[1-9]{1}[0-9]*</td> </tr> </table>	Kind	Value	pattern	[1-9]{1}[0-9]*
Kind	Value				
pattern	[1-9]{1}[0-9]*				

element **Riepilogo_Reddi_Type/ImponibileCedolare**

diagram	 p73:ImponibileCedolare				
namespace	urn:www.agenziaentrate.gov.it:specificheTecniche:sco:p73				
type	DatoNP_Type				
facets	<table border="1"> <tr> <td>Kind</td> <td>Value</td> </tr> <tr> <td>pattern</td> <td>[1-9]{1}[0-9]*</td> </tr> </table>	Kind	Value	pattern	[1-9]{1}[0-9]*
Kind	Value				
pattern	[1-9]{1}[0-9]*				

element **Riepilogo_Reddi_Type/ImponibileCedolareOrdinario**

diagram	 p73:ImponibileCedolareOrdinario				
namespace	urn:www.agenziaentrate.gov.it:specificheTecniche:sco:p73				
type	DatoNP_Type				
facets	<table border="1"> <tr> <td>Kind</td> <td>Value</td> </tr> <tr> <td>pattern</td> <td>[1-9]{1}[0-9]*</td> </tr> </table>	Kind	Value	pattern	[1-9]{1}[0-9]*
Kind	Value				
pattern	[1-9]{1}[0-9]*				

element **Riepilogo_Reddi_Type/ImponibileCedolareAgevolato**

diagram	 p73:ImponibileCedolareAgevolato				
namespace	urn:www.agenziaentrate.gov.it:specificheTecniche:sco:p73				
type	DatoNP_Type				
facets	<table border="1"> <tr> <td>Kind</td> <td>Value</td> </tr> <tr> <td>pattern</td> <td>[1-9]{1}[0-9]*</td> </tr> </table>	Kind	Value	pattern	[1-9]{1}[0-9]*
Kind	Value				
pattern	[1-9]{1}[0-9]*				

element **Riepilogo_Reddi_Type/AbitazionePrincipalePertinenze**

diagram	 p73:AbitazionePrincipalePertine...				
namespace	urn:www.agenziaentrate.gov.it:specificheTecniche:sco:p73				
type	DatoNP_Type				
facets	<table border="1"> <tr> <td>Kind</td> <td>Value</td> </tr> <tr> <td>pattern</td> <td>[1-9]{1}[0-9]*</td> </tr> </table>	Kind	Value	pattern	[1-9]{1}[0-9]*
Kind	Value				
pattern	[1-9]{1}[0-9]*				

complexType **Ritenute_Acconti_Sospesi_Type**

diagram	
namespace	urn:www.agenziaentrate.gov.it:specificheTecniche:sco:p73
children	p73:CodiceEvento p73:lrpef p73:AddRegionalelrpef p73:AddComunalelrpef p73:CedolareSecca p73:ContribSolidarieta

element **Ritenute_Acconti_Sospesi_Type/CodiceEvento**

diagram															
namespace	urn:www.agenziaentrate.gov.it:specificheTecniche:sco:p73														
type	p73:Codice Evento Eccezionale Type														
facets	<table border="0"> <tr> <td>Kind</td> <td>Value</td> </tr> <tr> <td>pattern</td> <td>[1-9]{1}[0-9]*</td> </tr> <tr> <td>enumeration</td> <td>1</td> </tr> <tr> <td>enumeration</td> <td>2</td> </tr> <tr> <td>enumeration</td> <td>3</td> </tr> <tr> <td>enumeration</td> <td>4</td> </tr> <tr> <td>enumeration</td> <td>30</td> </tr> </table>	Kind	Value	pattern	[1-9]{1}[0-9]*	enumeration	1	enumeration	2	enumeration	3	enumeration	4	enumeration	30
Kind	Value														
pattern	[1-9]{1}[0-9]*														
enumeration	1														
enumeration	2														
enumeration	3														
enumeration	4														
enumeration	30														

element **Ritenute_Acconti_Sospesi_Type/lrpef**

diagram					
namespace	urn:www.agenziaentrate.gov.it:specificheTecniche:sco:p73				
type	DatoNP Type				
facets	<table border="0"> <tr> <td>Kind</td> <td>Value</td> </tr> <tr> <td>pattern</td> <td>[1-9]{1}[0-9]*</td> </tr> </table>	Kind	Value	pattern	[1-9]{1}[0-9]*
Kind	Value				
pattern	[1-9]{1}[0-9]*				

element **Ritenute_Acconti_Sospesi_Type/AddRegionalelrpef**

diagram			
namespace	urn:www.agenziaentrate.gov.it:specificheTecniche:sco:p73		
type	DatoNP Type		
facets	<table border="0"> <tr> <td>Kind</td> <td>Value</td> </tr> </table>	Kind	Value
Kind	Value		

pattern	[1-9]{1}[0-9]*
---------	----------------

element Ritenute_Acconti_Sospesi_Type/AddComunalelrpef

diagram	
namespace	urn:www.agenziaentrate.gov.it:specificheTecniche:sco:p73
type	DatoNP_Type
facets	Kind Value pattern [1-9]{1}[0-9]*

element Ritenute_Acconti_Sospesi_Type/CedolareSecca

diagram	
namespace	urn:www.agenziaentrate.gov.it:specificheTecniche:sco:p73
type	DatoNP_Type
facets	Kind Value pattern [1-9]{1}[0-9]*

element Ritenute_Acconti_Sospesi_Type/ContribSolidarieta

diagram	
namespace	urn:www.agenziaentrate.gov.it:specificheTecniche:sco:p73
type	DatoNP_Type
facets	Kind Value pattern [1-9]{1}[0-9]*

complexType Ritenute_Lavoro_Dip_Type

diagram	
namespace	urn:www.agenziaentrate.gov.it:specificheTecniche:sco:p73
children	p73:Ritlrpef p73:RitAddRegionale p73:RitAccAddComunale p73:RitSaldoAddComunale p73:RitAccAddComAnnoPres

element **Ritenute_Lavoro_Dip_Type/Ritlrpef**

diagram	
namespace	urn:www.agenziaentrate.gov.it:specificheTecniche:sco:p73
type	DatoNP_Type
facets	Kind Value pattern [1-9]{1}[0-9]*

element **Ritenute_Lavoro_Dip_Type/RitAddRegionale**

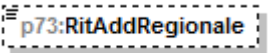
diagram	
namespace	urn:www.agenziaentrate.gov.it:specificheTecniche:sco:p73
type	DatoNP_Type
facets	Kind Value pattern [1-9]{1}[0-9]*

element **Ritenute_Lavoro_Dip_Type/RitAccAddComunale**

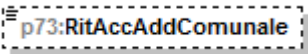
diagram	
namespace	urn:www.agenziaentrate.gov.it:specificheTecniche:sco:p73
type	DatoNP_Type
facets	Kind Value pattern [1-9]{1}[0-9]*

element **Ritenute_Lavoro_Dip_Type/RitSaldoAddComunale**

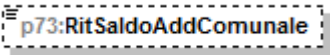
diagram	
namespace	urn:www.agenziaentrate.gov.it:specificheTecniche:sco:p73
type	DatoNP_Type
facets	Kind Value pattern [1-9]{1}[0-9]*

element **Ritenute_Lavoro_Dip_Type/RitAccAddComAnnoPres**

diagram	
namespace	urn:www.agenziaentrate.gov.it:specificheTecniche:sco:p73
type	DatoNP_Type
facets	Kind Value pattern [1-9]{1}[0-9]*

complexType **Sezione_Altri_Redd_Type**

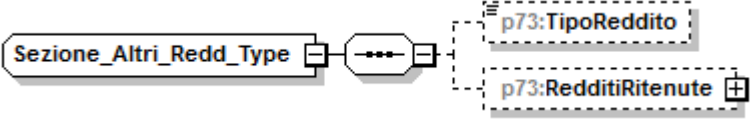
diagram	
namespace	urn:www.agenziaentrate.gov.it:specificheTecniche:sco:p73
children	p73:TipoReddito p73:RedditiRitenute

element **Sezione_Altri_Redd_Type/TipoReddito**

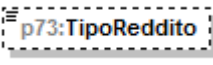
diagram																					
namespace	urn:www.agenziaentrate.gov.it:specificheTecniche:sco:p73																				
type	p73:Tipo_Reddito_Data8_Type																				
facets	<table border="0"> <thead> <tr> <th>Kind</th> <th>Value</th> </tr> </thead> <tbody> <tr> <td>pattern</td> <td>[1-9]{1}[0-9]*</td> </tr> <tr> <td>enumeration</td> <td>1</td> </tr> <tr> <td>enumeration</td> <td>2</td> </tr> <tr> <td>enumeration</td> <td>3</td> </tr> <tr> <td>enumeration</td> <td>4</td> </tr> <tr> <td>enumeration</td> <td>5</td> </tr> <tr> <td>enumeration</td> <td>6</td> </tr> <tr> <td>enumeration</td> <td>7</td> </tr> <tr> <td>enumeration</td> <td>8</td> </tr> </tbody> </table>	Kind	Value	pattern	[1-9]{1}[0-9]*	enumeration	1	enumeration	2	enumeration	3	enumeration	4	enumeration	5	enumeration	6	enumeration	7	enumeration	8
Kind	Value																				
pattern	[1-9]{1}[0-9]*																				
enumeration	1																				
enumeration	2																				
enumeration	3																				
enumeration	4																				
enumeration	5																				
enumeration	6																				
enumeration	7																				
enumeration	8																				

element **Sezione_Altri_Redd_Type/RedditiRitenute**

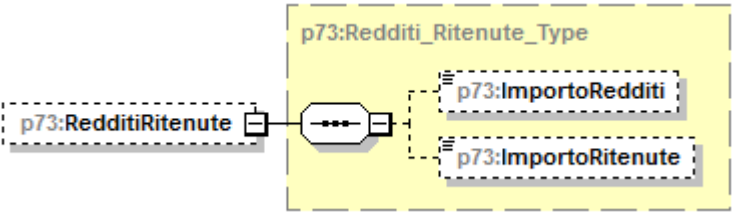
diagram	
namespace	urn:www.agenziaentrate.gov.it:specificheTecniche:sco:p73
type	p73:Redditi_Ritenute_Type
children	p73:ImportoRedditi p73:ImportoRitenute

complexType **Sezione_Dati_Catastali_Recupero_Patrimonio_Edilizio_Type**

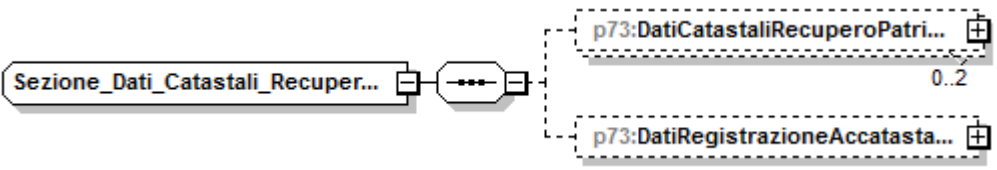
diagram	
namespace	urn:www.agenziaentrate.gov.it:specificheTecniche:sco:p73
children	p73:DatiCatastaliRecuperoPatrimonioEdilizio p73:DatiRegistrazioneAccatamentoRecuperoPatrimonio_Edilizio

element

Sezione_Dati_Catastali_Recupero_Patrimonio_Edilizio_Type/DatiCatastaliRecuperoPatrimonioEdilizio

diagram	<p>The diagram shows a dashed box representing the extension <code>p73:Dati_Catastali_Recupero_Patrimonio_Edilizio_Type (extension)</code>. It contains three elements: <code>p73:NOrdImmibile</code>, <code>p73:Condominio</code>, and <code>p73:DatiCatastali</code>. A solid box on the left represents the base type <code>p73:DatiCatastaliRecuperoPatri...</code> with a cardinality of <code>0..2</code>. A dashed line with a plus sign indicates the extension relationship.</p>
namespace	urn:www.agenziaentrate.gov.it:specificheTecniche:sco:p73
type	extension of p73:Dati_Catastali_Recupero_Patrimonio_Edilizio_Type
children	p73:NOrdImmibile p73:Condominio p73:DatiCatastali

element

Sezione_Dati_Catastali_Recupero_Patrimonio_Edilizio_Type/DatiRegistrazioneAccatastamentoRecuperoPatrimonio_Edilizio

diagram	<p>The diagram shows a dashed box representing the extension <code>p73:Dati_Registrazione_Accatastamento_Recupero_Patrimonio_Edilizio_Type</code>. It contains four elements: <code>p73:NOrdImmibile</code>, <code>p73:Condominio</code>, <code>p73:EstremiRegistrazioneContr...</code>, and <code>p73:DomandaAccatastamento</code>. A solid box on the left represents the base type <code>p73:DatiRegistrazioneAccatasta...</code>. A dashed line with a plus sign indicates the extension relationship.</p>
namespace	urn:www.agenziaentrate.gov.it:specificheTecniche:sco:p73
type	p73:Dati_Registrazione_Accatastamento_Recupero_Patrimonio_Edilizio_Type
children	p73:NOrdImmibile p73:Condominio p73:EstremiRegistrazioneContratto p73:DomandaAccatastamento

complexType Soggetto_Fiscale_730_Type

diagram	<p>The diagram shows a solid box representing the complex type <code>Soggetto_Fiscale_730_Type</code>. It contains four elements: <code>p73:CodiceFiscale</code>, <code>p73:Email</code>, <code>p73:Telefono</code>, and <code>p73:Cellulare</code>.</p>
namespace	urn:www.agenziaentrate.gov.it:specificheTecniche:sco:p73
children	p73:CodiceFiscale p73:Email p73:Telefono p73:Cellulare

element Soggetto_Fiscale_730_Type/CodiceFiscale

diagram	
namespace	urn:www.agenziaentrate.gov.it:specificheTecniche:sco:p73
type	DatoCF_Type
facets	Kind Value pattern [0-9]{11}[A-Z]{6}[0-9LMNPQRSTUUV]{2}[A-Z]{1}[0-9LMNPQRSTUUV]{2}[A-Z]{1}[0-9LMNPQRSTUUV]{3}[A-Z]{1}

element Soggetto_Fiscale_730_Type/Email

diagram	
namespace	urn:www.agenziaentrate.gov.it:specificheTecniche:sco:p73
type	DatoEM_Type
facets	Kind Value pattern [a-zA-Z0-9_%\-'"?^~=]+@[a-zA-Z0-9\-\.\ /^*\(\)\!@ è é ì ò ù ü ";\ \ \ /+)*

element Soggetto_Fiscale_730_Type/Telefono

diagram	
namespace	urn:www.agenziaentrate.gov.it:specificheTecniche:sco:p73
type	DatoAN_Type
facets	Kind Value pattern ([0-9A-Z- "){1}([0-9A-Z&:] \- \., / \^*\(\ \) À È É Ì Ò Ù Ü ";\ \ \ /+)*

element Soggetto_Fiscale_730_Type/Cellulare

diagram	
namespace	urn:www.agenziaentrate.gov.it:specificheTecniche:sco:p73
type	DatoAN_Type
facets	Kind Value pattern ([0-9A-Z- "){1}([0-9A-Z&:] \- \., / \^*\(\ \) À È É Ì Ò Ù Ü ";\ \ \ /+)*

complexType Soglie_Esenzione_Type

diagram	
namespace	urn:www.agenziaentrate.gov.it:specificheTecniche:sco:p73

children	p73:SogliaEsenzione p73:EsenzioneTotale
----------	---

element **Soglie_Esenzione_Type/SogliaEsenzione**

diagram					
namespace	urn:www.agenziaentrate.gov.it:specificheTecniche:sco:p73				
type	DatoNP_Type				
facets	<table border="0"> <tr> <td>Kind</td> <td>Value</td> </tr> <tr> <td>pattern</td> <td>[1-9]{1}[0-9]*</td> </tr> </table>	Kind	Value	pattern	[1-9]{1}[0-9]*
Kind	Value				
pattern	[1-9]{1}[0-9]*				

element **Soglie_Esenzione_Type/EsenzioneTotale**

diagram									
namespace	urn:www.agenziaentrate.gov.it:specificheTecniche:sco:p73								
type	restriction of DatoN1_Type								
facets	<table border="0"> <tr> <td>Kind</td> <td>Value</td> </tr> <tr> <td>pattern</td> <td>[1-9]</td> </tr> <tr> <td>enumeration</td> <td>1</td> </tr> <tr> <td>enumeration</td> <td>2</td> </tr> </table>	Kind	Value	pattern	[1-9]	enumeration	1	enumeration	2
Kind	Value								
pattern	[1-9]								
enumeration	1								
enumeration	2								

complexType **Spese_Arredo_Type**

diagram	
namespace	urn:www.agenziaentrate.gov.it:specificheTecniche:sco:p73
children	p73:NumeroRata p73:Importo

element **Spese_Arredo_Type/NumeroRata**

diagram											
namespace	urn:www.agenziaentrate.gov.it:specificheTecniche:sco:p73										
type	p73:Numero_RateDa1A3_Type										
facets	<table border="0"> <tr> <td>Kind</td> <td>Value</td> </tr> <tr> <td>pattern</td> <td>[1-9]</td> </tr> <tr> <td>enumeration</td> <td>1</td> </tr> <tr> <td>enumeration</td> <td>2</td> </tr> <tr> <td>enumeration</td> <td>3</td> </tr> </table>	Kind	Value	pattern	[1-9]	enumeration	1	enumeration	2	enumeration	3
Kind	Value										
pattern	[1-9]										
enumeration	1										
enumeration	2										
enumeration	3										

element **Spese_Arredo_Type/Importo**

diagram					
namespace	urn:www.agenziaentrate.gov.it:specificheTecniche:sco:p73				
type	DatoNP_Type				
facets	<table border="1"> <tr> <th>Kind</th> <th>Value</th> </tr> <tr> <td>pattern</td> <td>[1-9]{1}[0-9]*</td> </tr> </table>	Kind	Value	pattern	[1-9]{1}[0-9]*
Kind	Value				
pattern	[1-9]{1}[0-9]*				

complexType **Spese_Rateizzate_Anni_Precedenti_Type**

diagram	
namespace	urn:www.agenziaentrate.gov.it:specificheTecniche:sco:p73
children	p73:Codice p73:Importo

element **Spese_Rateizzate_Anni_Precedenti_Type/Codice**

diagram											
namespace	urn:www.agenziaentrate.gov.it:specificheTecniche:sco:p73										
type	p73:Codice Spese_Rateizzate_Anni_Precedenti_Type										
facets	<table border="1"> <tr> <th>Kind</th> <th>Value</th> </tr> <tr> <td>pattern</td> <td>[1-9]{1}[0-9]*</td> </tr> <tr> <td>enumeration</td> <td>2</td> </tr> <tr> <td>enumeration</td> <td>3</td> </tr> <tr> <td>enumeration</td> <td>4</td> </tr> </table>	Kind	Value	pattern	[1-9]{1}[0-9]*	enumeration	2	enumeration	3	enumeration	4
Kind	Value										
pattern	[1-9]{1}[0-9]*										
enumeration	2										
enumeration	3										
enumeration	4										

element **Spese_Rateizzate_Anni_Precedenti_Type/Importo**

diagram					
namespace	urn:www.agenziaentrate.gov.it:specificheTecniche:sco:p73				
type	DatoNP_Type				
facets	<table border="1"> <tr> <th>Kind</th> <th>Value</th> </tr> <tr> <td>pattern</td> <td>[1-9]{1}[0-9]*</td> </tr> </table>	Kind	Value	pattern	[1-9]{1}[0-9]*
Kind	Value				
pattern	[1-9]{1}[0-9]*				

complexType **Spese_Rateizzate_Type**

diagram	
namespace	urn:www.agenziaentrate.gov.it:specificheTecniche:sco:p73

children	p73:Codice p73:Importo
----------	--

element Spese_Rateizzate_Type/Codice

diagram													
namespace	urn:www.agenziaentrate.gov.it:specificheTecniche:sco:p73												
type	p73:Codice Spese Rateizzate Type												
facets	<table border="1"> <thead> <tr> <th>Kind</th> <th>Value</th> </tr> </thead> <tbody> <tr> <td>pattern</td> <td>[1-9]{1}[0-9]*</td> </tr> <tr> <td>enumeration</td> <td>1</td> </tr> <tr> <td>enumeration</td> <td>2</td> </tr> <tr> <td>enumeration</td> <td>3</td> </tr> <tr> <td>enumeration</td> <td>4</td> </tr> </tbody> </table>	Kind	Value	pattern	[1-9]{1}[0-9]*	enumeration	1	enumeration	2	enumeration	3	enumeration	4
Kind	Value												
pattern	[1-9]{1}[0-9]*												
enumeration	1												
enumeration	2												
enumeration	3												
enumeration	4												

element Spese_Rateizzate_Type/Importo

diagram					
namespace	urn:www.agenziaentrate.gov.it:specificheTecniche:sco:p73				
type	DatoNP Type				
facets	<table border="1"> <thead> <tr> <th>Kind</th> <th>Value</th> </tr> </thead> <tbody> <tr> <td>pattern</td> <td>[1-9]{1}[0-9]*</td> </tr> </tbody> </table>	Kind	Value	pattern	[1-9]{1}[0-9]*
Kind	Value				
pattern	[1-9]{1}[0-9]*				

complexType Tassazione_Separata_Type

diagram	
namespace	urn:www.agenziaentrate.gov.it:specificheTecniche:sco:p73
children	p73:Opzione p73:Anno p73:RedditoRitenute

element Tassazione_Separata_Type/Opzione

diagram					
namespace	urn:www.agenziaentrate.gov.it:specificheTecniche:sco:p73				
type	DatoCB Type				
facets	<table border="1"> <thead> <tr> <th>Kind</th> <th>Value</th> </tr> </thead> <tbody> <tr> <td>pattern</td> <td>[01]</td> </tr> </tbody> </table>	Kind	Value	pattern	[01]
Kind	Value				
pattern	[01]				

element Tassazione_Separata_Type/Anno

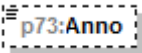
diagram	
namespace	urn:www.agenziaentrate.gov.it:specificheTecniche:sco:p73
type	DatoDA_Type
facets	Kind Value pattern (18 19 20)[0-9]{2}

element Tassazione_Separata_Type/RedditoRitenute

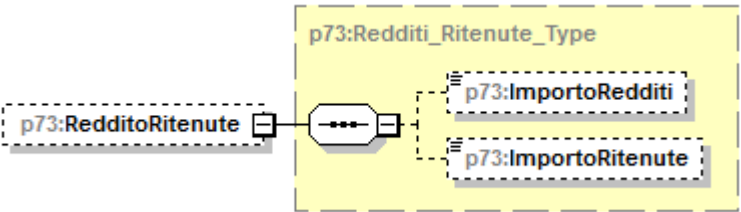
diagram	
namespace	urn:www.agenziaentrate.gov.it:specificheTecniche:sco:p73
type	p73:Redditi_Ritenute_Type
children	p73:ImportoRedditi p73:ImportoRitenute

complexType Terreno_Type

diagram	
namespace	urn:www.agenziaentrate.gov.it:specificheTecniche:sco:p73
children	p73:RedDominicale p73:Titolo p73:RedAgrario p73:GiorniPossesso p73:PercPossesso p73:CanoneVincolistico p73:CasiParticolari p73:CasellaContinuazione p73:CasellalmuNonDovuta p73:CasellaColtivatoreDiretto

element Terreno_Type/RedDominicale

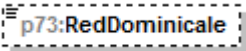
diagram					
namespace	urn:www.agenziaentrate.gov.it:specificheTecniche:sco:p73				
type	DatoNP_Type				
facets	<table border="1"> <thead> <tr> <th>Kind</th> <th>Value</th> </tr> </thead> <tbody> <tr> <td>pattern</td> <td>[1-9]{1}[0-9]*</td> </tr> </tbody> </table>	Kind	Value	pattern	[1-9]{1}[0-9]*
Kind	Value				
pattern	[1-9]{1}[0-9]*				

element Terreno_Type/Titolo

diagram																					
namespace	urn:www.agenziaentrate.gov.it:specificheTecniche:sco:p73																				
type	p73:Titolo_Terreno_Type																				
facets	<table border="1"> <thead> <tr> <th>Kind</th> <th>Value</th> </tr> </thead> <tbody> <tr> <td>pattern</td> <td>[1-9]{1}[0-9]*</td> </tr> <tr> <td>enumeration</td> <td>1</td> </tr> <tr> <td>enumeration</td> <td>2</td> </tr> <tr> <td>enumeration</td> <td>3</td> </tr> <tr> <td>enumeration</td> <td>4</td> </tr> <tr> <td>enumeration</td> <td>5</td> </tr> <tr> <td>enumeration</td> <td>6</td> </tr> <tr> <td>enumeration</td> <td>7</td> </tr> <tr> <td>enumeration</td> <td>10</td> </tr> </tbody> </table>	Kind	Value	pattern	[1-9]{1}[0-9]*	enumeration	1	enumeration	2	enumeration	3	enumeration	4	enumeration	5	enumeration	6	enumeration	7	enumeration	10
Kind	Value																				
pattern	[1-9]{1}[0-9]*																				
enumeration	1																				
enumeration	2																				
enumeration	3																				
enumeration	4																				
enumeration	5																				
enumeration	6																				
enumeration	7																				
enumeration	10																				

element Terreno_Type/RedAgrario

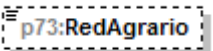
diagram					
namespace	urn:www.agenziaentrate.gov.it:specificheTecniche:sco:p73				
type	DatoNP_Type				
facets	<table border="1"> <thead> <tr> <th>Kind</th> <th>Value</th> </tr> </thead> <tbody> <tr> <td>pattern</td> <td>[1-9]{1}[0-9]*</td> </tr> </tbody> </table>	Kind	Value	pattern	[1-9]{1}[0-9]*
Kind	Value				
pattern	[1-9]{1}[0-9]*				

element Terreno_Type/GiorniPossesso

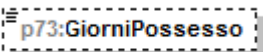
diagram					
namespace	urn:www.agenziaentrate.gov.it:specificheTecniche:sco:p73				
type	DatoGA_Type				
facets	<table border="1"> <thead> <tr> <th>Kind</th> <th>Value</th> </tr> </thead> <tbody> <tr> <td>pattern</td> <td>[1-9]((1-9)[0-9]) ((12)[0-9][0-9]) (3[0-5][0-9]) (36[0-5])</td> </tr> </tbody> </table>	Kind	Value	pattern	[1-9]((1-9)[0-9]) ((12)[0-9][0-9]) (3[0-5][0-9]) (36[0-5])
Kind	Value				
pattern	[1-9]((1-9)[0-9]) ((12)[0-9][0-9]) (3[0-5][0-9]) (36[0-5])				

element **Terreno_Type/PercPossesso**

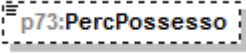
diagram					
namespace	urn:www.agenziaentrate.gov.it:specificheTecniche:sco:p73				
type	DatoPC_Type				
facets	<table border="1"> <thead> <tr> <th>Kind</th> <th>Value</th> </tr> </thead> <tbody> <tr> <td>pattern</td> <td>[0-9]?[0-9](,\d{1,3})? 100,0{1,3}?</td> </tr> </tbody> </table>	Kind	Value	pattern	[0-9]?[0-9](,\d{1,3})? 100,0{1,3}?
Kind	Value				
pattern	[0-9]?[0-9](,\d{1,3})? 100,0{1,3}?				

element **Terreno_Type/CanoneVincolistico**

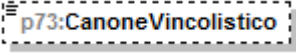
diagram					
namespace	urn:www.agenziaentrate.gov.it:specificheTecniche:sco:p73				
type	DatoNP_Type				
facets	<table border="1"> <thead> <tr> <th>Kind</th> <th>Value</th> </tr> </thead> <tbody> <tr> <td>pattern</td> <td>[1-9]{1}[0-9]*</td> </tr> </tbody> </table>	Kind	Value	pattern	[1-9]{1}[0-9]*
Kind	Value				
pattern	[1-9]{1}[0-9]*				

element **Terreno_Type/CasiParticolari**

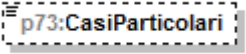
diagram													
namespace	urn:www.agenziaentrate.gov.it:specificheTecniche:sco:p73												
type	p73:Casi Particolari Terreni_Type												
facets	<table border="1"> <thead> <tr> <th>Kind</th> <th>Value</th> </tr> </thead> <tbody> <tr> <td>pattern</td> <td>[1-9]</td> </tr> <tr> <td>enumeration</td> <td>2</td> </tr> <tr> <td>enumeration</td> <td>3</td> </tr> <tr> <td>enumeration</td> <td>4</td> </tr> <tr> <td>enumeration</td> <td>6</td> </tr> </tbody> </table>	Kind	Value	pattern	[1-9]	enumeration	2	enumeration	3	enumeration	4	enumeration	6
Kind	Value												
pattern	[1-9]												
enumeration	2												
enumeration	3												
enumeration	4												
enumeration	6												

element **Terreno_Type/CasellaContinuazione**

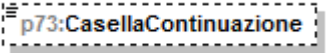
diagram					
namespace	urn:www.agenziaentrate.gov.it:specificheTecniche:sco:p73				
type	DatoCB_Type				
facets	<table border="1"> <thead> <tr> <th>Kind</th> <th>Value</th> </tr> </thead> <tbody> <tr> <td>pattern</td> <td>[01]</td> </tr> </tbody> </table>	Kind	Value	pattern	[01]
Kind	Value				
pattern	[01]				

element **Terreno_Type/CasellalmuNonDovuta**

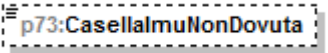
diagram	
namespace	urn:www.agenziaentrate.gov.it:specificheTecniche:sco:p73
type	DatoCB_Type

facets	Kind pattern	Value [01]
--------	-----------------	---------------

element Terreno_Type/CasellaColtivatoreDiretto

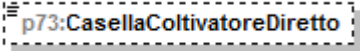
diagram		
namespace	urn:www.agenziaentrate.gov.it:specificheTecniche:sco:p73	
type	DatoCB_Type	
facets	Kind pattern	Value [01]

simpleType Anno_Anticipazione_Fondo_Pensione_Type

namespace	urn:www.agenziaentrate.gov.it:specificheTecniche:sco:p73	
type	restriction of DatoNP_Type	
facets	Kind pattern enumeration enumeration enumeration enumeration enumeration enumeration enumeration enumeration enumeration	Value [1-9]{1}[0-9]* 2007 2008 2009 2010 2011 2012 2013 2014 2015

simpleType Anno_Patrimonio_Edilizio_Situazioni_Particolari_Type

namespace	urn:www.agenziaentrate.gov.it:specificheTecniche:sco:p73	
type	restriction of DatoNP_Type	
facets	Kind pattern enumeration	Value [1-9]{1}[0-9]* 2011

simpleType Anno_Recupero_Patrimonio_Edilizio_Type

namespace	urn:www.agenziaentrate.gov.it:specificheTecniche:sco:p73	
type	restriction of DatoNP_Type	
facets	Kind pattern enumeration enumeration enumeration enumeration enumeration enumeration enumeration enumeration enumeration enumeration	Value [1-9]{1}[0-9]* 2005 2006 2007 2008 2009 2010 2011 2012 2013 2014 2015

simpleType Anno_Risparmio_Energetico_Type

namespace	urn:www.agenziaentrate.gov.it:specificheTecniche:sco:p73	
type	restriction of DatoNP_Type	
facets	Kind	Value
	pattern	[1-9]{1}[0-9]*
	enumeration	2008
	enumeration	2010
	enumeration	2011
	enumeration	2012
	enumeration	2013
	enumeration	2014
	enumeration	2015

simpleType Casella_Codice_Type

namespace	urn:www.agenziaentrate.gov.it:specificheTecniche:sco:p73	
type	restriction of DatoN1_Type	
facets	Kind	Value
	pattern	[1-9]
	enumeration	1
	enumeration	4

simpleType Casi_Particolari_Fabbricato_Type

namespace	urn:www.agenziaentrate.gov.it:specificheTecniche:sco:p73	
type	restriction of DatoN1_Type	
facets	Kind	Value
	pattern	[1-9]
	enumeration	1
	enumeration	3
	enumeration	4
	enumeration	5
	enumeration	6

simpleType Casi_Particolari_Risp_Ener_Type

namespace	urn:www.agenziaentrate.gov.it:specificheTecniche:sco:p73	
type	restriction of DatoN1_Type	
facets	Kind	Value
	pattern	[1-9]
	enumeration	1
	enumeration	2
	enumeration	3

simpleType Casi_Particolari_Terreni_Type

namespace	urn:www.agenziaentrate.gov.it:specificheTecniche:sco:p73	
type	restriction of DatoN1_Type	
facets	Kind	Value
	pattern	[1-9]
	enumeration	2
	enumeration	3
	enumeration	4

	enumeration	6
--	-------------	---

simpleType Codice_Altre_Detrazioni_Type

namespace	urn:www.agenziaentrate.gov.it:specificheTecniche:sco:p73	
type	restriction of DatoNP_Type	
facets	Kind	Value
	pattern	[1-9]{1}[0-9]*
	enumeration	1
	enumeration	2

simpleType Codice_Altre_Spese_Type

namespace	urn:www.agenziaentrate.gov.it:specificheTecniche:sco:p73	
type	restriction of DatoNP_Type	
facets	Kind	Value
	pattern	[1-9]{1}[0-9]*
	enumeration	8
	enumeration	9
	enumeration	10
	enumeration	11
	enumeration	12
	enumeration	13
	enumeration	14
	enumeration	15
	enumeration	16
	enumeration	17
	enumeration	18
	enumeration	20
	enumeration	21
	enumeration	22
	enumeration	23
	enumeration	24
	enumeration	25
	enumeration	26
	enumeration	27
	enumeration	28
	enumeration	29
	enumeration	30
	enumeration	31
	enumeration	32
	enumeration	33
	enumeration	35
	enumeration	36
	enumeration	37
	enumeration	41
	enumeration	42
	enumeration	99

simpleType Codice_Altri_Oneri_Type

namespace	urn:www.agenziaentrate.gov.it:specificheTecniche:sco:p73	
type	restriction of DatoNP_Type	
facets	Kind	Value
	pattern	[1-9]{1}[0-9]*
	enumeration	6
	enumeration	7
	enumeration	8
	enumeration	9
	enumeration	11

simpleType Codice_Canone_Type

namespace	urn:www.agenziaentrate.gov.it:specificheTecniche:sco:p73												
type	restriction of DatoN1_Type												
facets	<table border="1"> <thead> <tr> <th>Kind</th> <th>Value</th> </tr> </thead> <tbody> <tr> <td>pattern</td> <td>[1-9]</td> </tr> <tr> <td>enumeration</td> <td>1</td> </tr> <tr> <td>enumeration</td> <td>2</td> </tr> <tr> <td>enumeration</td> <td>3</td> </tr> <tr> <td>enumeration</td> <td>4</td> </tr> </tbody> </table>	Kind	Value	pattern	[1-9]	enumeration	1	enumeration	2	enumeration	3	enumeration	4
Kind	Value												
pattern	[1-9]												
enumeration	1												
enumeration	2												
enumeration	3												
enumeration	4												

simpleType Codice_Evento_Eccezionale_Type

namespace	urn:www.agenziaentrate.gov.it:specificheTecniche:sco:p73														
type	restriction of DatoNP_Type														
facets	<table border="1"> <thead> <tr> <th>Kind</th> <th>Value</th> </tr> </thead> <tbody> <tr> <td>pattern</td> <td>[1-9]{1}[0-9]*</td> </tr> <tr> <td>enumeration</td> <td>1</td> </tr> <tr> <td>enumeration</td> <td>2</td> </tr> <tr> <td>enumeration</td> <td>3</td> </tr> <tr> <td>enumeration</td> <td>4</td> </tr> <tr> <td>enumeration</td> <td>30</td> </tr> </tbody> </table>	Kind	Value	pattern	[1-9]{1}[0-9]*	enumeration	1	enumeration	2	enumeration	3	enumeration	4	enumeration	30
Kind	Value														
pattern	[1-9]{1}[0-9]*														
enumeration	1														
enumeration	2														
enumeration	3														
enumeration	4														
enumeration	30														

simpleType Codice_Spese_Rateizzate_Anni_Precedenti_Type

namespace	urn:www.agenziaentrate.gov.it:specificheTecniche:sco:p73										
type	restriction of DatoNP_Type										
facets	<table border="1"> <thead> <tr> <th>Kind</th> <th>Value</th> </tr> </thead> <tbody> <tr> <td>pattern</td> <td>[1-9]{1}[0-9]*</td> </tr> <tr> <td>enumeration</td> <td>2</td> </tr> <tr> <td>enumeration</td> <td>3</td> </tr> <tr> <td>enumeration</td> <td>4</td> </tr> </tbody> </table>	Kind	Value	pattern	[1-9]{1}[0-9]*	enumeration	2	enumeration	3	enumeration	4
Kind	Value										
pattern	[1-9]{1}[0-9]*										
enumeration	2										
enumeration	3										
enumeration	4										

simpleType Codice_Spese_Rateizzate_Type

namespace	urn:www.agenziaentrate.gov.it:specificheTecniche:sco:p73												
type	restriction of DatoNP_Type												
facets	<table border="1"> <thead> <tr> <th>Kind</th> <th>Value</th> </tr> </thead> <tbody> <tr> <td>pattern</td> <td>[1-9]{1}[0-9]*</td> </tr> <tr> <td>enumeration</td> <td>1</td> </tr> <tr> <td>enumeration</td> <td>2</td> </tr> <tr> <td>enumeration</td> <td>3</td> </tr> <tr> <td>enumeration</td> <td>4</td> </tr> </tbody> </table>	Kind	Value	pattern	[1-9]{1}[0-9]*	enumeration	1	enumeration	2	enumeration	3	enumeration	4
Kind	Value												
pattern	[1-9]{1}[0-9]*												
enumeration	1												
enumeration	2												
enumeration	3												
enumeration	4												

simpleType Fabbricato_Agevolazione_Numero_Rigo_Type

namespace	urn:www.agenziaentrate.gov.it:specificheTecniche:sco:p73										
type	restriction of DatoNP_Type										
facets	<table border="1"> <thead> <tr> <th>Kind</th> <th>Value</th> </tr> </thead> <tbody> <tr> <td>pattern</td> <td>[1-9]{1}[0-9]*</td> </tr> <tr> <td>enumeration</td> <td>1</td> </tr> <tr> <td>enumeration</td> <td>2</td> </tr> <tr> <td>enumeration</td> <td>3</td> </tr> </tbody> </table>	Kind	Value	pattern	[1-9]{1}[0-9]*	enumeration	1	enumeration	2	enumeration	3
Kind	Value										
pattern	[1-9]{1}[0-9]*										
enumeration	1										
enumeration	2										
enumeration	3										

	enumeration	4
	enumeration	5
	enumeration	6
	enumeration	7
	enumeration	8
	enumeration	9
	enumeration	10

simpleType Indeterminato_Determinato_Type

namespace	urn:www.agenziaentrate.gov.it:specificheTecniche:sco:p73	
type	restriction of DatoN1_Type	
facets	Kind	Value
	pattern	[1-9]
	enumeration	1
	enumeration	2

simpleType Mesi_Type

namespace	urn:www.agenziaentrate.gov.it:specificheTecniche:sco:p73	
type	restriction of DatoNP_Type	
facets	Kind	Value
	pattern	[1-9]{1}[0-9]*
	enumeration	1
	enumeration	2
	enumeration	3
	enumeration	4
	enumeration	5
	enumeration	6
	enumeration	7
	enumeration	8
	enumeration	9
	enumeration	10
	enumeration	11
	enumeration	12

simpleType Numero_Rata_Risparmio_Energetico_Type

namespace	urn:www.agenziaentrate.gov.it:specificheTecniche:sco:p73	
type	restriction of DatoNP_Type	
facets	Kind	Value
	pattern	[1-9]{1}[0-9]*
	enumeration	1
	enumeration	2
	enumeration	3
	enumeration	4
	enumeration	5
	enumeration	8

simpleType Numero_Rate5o10_Type

namespace	urn:www.agenziaentrate.gov.it:specificheTecniche:sco:p73	
type	restriction of DatoNP_Type	
facets	Kind	Value
	pattern	[1-9]{1}[0-9]*
	enumeration	5
	enumeration	10

simpleType Numero_RateDa1A3_Type

namespace	urn:www.agenziaentrate.gov.it:specificheTecniche:sco:p73										
type	restriction of DatoN1_Type										
facets	<table border="1"> <thead> <tr> <th>Kind</th> <th>Value</th> </tr> </thead> <tbody> <tr> <td>pattern</td> <td>[1-9]</td> </tr> <tr> <td>enumeration</td> <td>1</td> </tr> <tr> <td>enumeration</td> <td>2</td> </tr> <tr> <td>enumeration</td> <td>3</td> </tr> </tbody> </table>	Kind	Value	pattern	[1-9]	enumeration	1	enumeration	2	enumeration	3
Kind	Value										
pattern	[1-9]										
enumeration	1										
enumeration	2										
enumeration	3										

simpleType Numero_RateDa1A7_Type

namespace	urn:www.agenziaentrate.gov.it:specificheTecniche:sco:p73																		
type	restriction of DatoN1_Type																		
facets	<table border="1"> <thead> <tr> <th>Kind</th> <th>Value</th> </tr> </thead> <tbody> <tr> <td>pattern</td> <td>[1-9]</td> </tr> <tr> <td>enumeration</td> <td>1</td> </tr> <tr> <td>enumeration</td> <td>2</td> </tr> <tr> <td>enumeration</td> <td>3</td> </tr> <tr> <td>enumeration</td> <td>4</td> </tr> <tr> <td>enumeration</td> <td>5</td> </tr> <tr> <td>enumeration</td> <td>6</td> </tr> <tr> <td>enumeration</td> <td>7</td> </tr> </tbody> </table>	Kind	Value	pattern	[1-9]	enumeration	1	enumeration	2	enumeration	3	enumeration	4	enumeration	5	enumeration	6	enumeration	7
Kind	Value																		
pattern	[1-9]																		
enumeration	1																		
enumeration	2																		
enumeration	3																		
enumeration	4																		
enumeration	5																		
enumeration	6																		
enumeration	7																		

simpleType Periodo_Spese_Ristrutturazione_Type

namespace	urn:www.agenziaentrate.gov.it:specificheTecniche:sco:p73												
type	restriction of DatoN1_Type												
facets	<table border="1"> <thead> <tr> <th>Kind</th> <th>Value</th> </tr> </thead> <tbody> <tr> <td>pattern</td> <td>[1-9]</td> </tr> <tr> <td>enumeration</td> <td>1</td> </tr> <tr> <td>enumeration</td> <td>2</td> </tr> <tr> <td>enumeration</td> <td>3</td> </tr> <tr> <td>enumeration</td> <td>4</td> </tr> </tbody> </table>	Kind	Value	pattern	[1-9]	enumeration	1	enumeration	2	enumeration	3	enumeration	4
Kind	Value												
pattern	[1-9]												
enumeration	1												
enumeration	2												
enumeration	3												
enumeration	4												

simpleType Rate10_Type

namespace	urn:www.agenziaentrate.gov.it:specificheTecniche:sco:p73																								
type	restriction of DatoNP_Type																								
facets	<table border="1"> <thead> <tr> <th>Kind</th> <th>Value</th> </tr> </thead> <tbody> <tr> <td>pattern</td> <td>[1-9]{1}[0-9]*</td> </tr> <tr> <td>enumeration</td> <td>1</td> </tr> <tr> <td>enumeration</td> <td>2</td> </tr> <tr> <td>enumeration</td> <td>3</td> </tr> <tr> <td>enumeration</td> <td>4</td> </tr> <tr> <td>enumeration</td> <td>5</td> </tr> <tr> <td>enumeration</td> <td>6</td> </tr> <tr> <td>enumeration</td> <td>7</td> </tr> <tr> <td>enumeration</td> <td>8</td> </tr> <tr> <td>enumeration</td> <td>9</td> </tr> <tr> <td>enumeration</td> <td>10</td> </tr> </tbody> </table>	Kind	Value	pattern	[1-9]{1}[0-9]*	enumeration	1	enumeration	2	enumeration	3	enumeration	4	enumeration	5	enumeration	6	enumeration	7	enumeration	8	enumeration	9	enumeration	10
Kind	Value																								
pattern	[1-9]{1}[0-9]*																								
enumeration	1																								
enumeration	2																								
enumeration	3																								
enumeration	4																								
enumeration	5																								
enumeration	6																								
enumeration	7																								
enumeration	8																								
enumeration	9																								
enumeration	10																								

simpleType Rate5_Type

namespace	urn:www.agenziaentrate.gov.it:specificheTecniche:sco:p73	
type	restriction of DatoNP_Type	
facets	Kind	Value
	pattern	[1-9]{1}[0-9]*
	enumeration	5

simpleType Rate_Risparmio_Energetico_Type

namespace	urn:www.agenziaentrate.gov.it:specificheTecniche:sco:p73	
type	restriction of DatoNP_Type	
facets	Kind	Value
	pattern	[1-9]{1}[0-9]*
	enumeration	3
	enumeration	4
	enumeration	5
	enumeration	6
	enumeration	7
	enumeration	8
	enumeration	9
	enumeration	10

simpleType Reintegro_Totale_Parziale_Type

namespace	urn:www.agenziaentrate.gov.it:specificheTecniche:sco:p73	
type	restriction of DatoN1_Type	
facets	Kind	Value
	pattern	[1-9]
	enumeration	1
	enumeration	2

simpleType Rideterminazione_Rate_Type

namespace	urn:www.agenziaentrate.gov.it:specificheTecniche:sco:p73	
type	restriction of DatoNP_Type	
facets	Kind	Value
	pattern	[1-9]{1}[0-9]*
	enumeration	10

simpleType Ripart_Risparmio_Energetico_Type

namespace	urn:www.agenziaentrate.gov.it:specificheTecniche:sco:p73	
type	restriction of DatoNP_Type	
facets	Kind	Value
	pattern	[1-9]{1}[0-9]*
	enumeration	8
	enumeration	9
	enumeration	10

simpleType Serie_Registrazione_Contratto_Type

namespace	urn:www.agenziaentrate.gov.it:specificheTecniche:sco:p73	
-----------	--	--

type	restriction of DatoAN_Type														
facets	<table border="0"> <tr> <td>Kind</td> <td>Value</td> </tr> <tr> <td>pattern</td> <td>([0-9A-Z-])&quot;){1}([0-9A-Z&amp;:] ' \\-\\. , / ° \\^\\(\\ \\)\\À È É Ì Ò Ù Ü &quot; \\ \\ \\+)*</td> </tr> <tr> <td>enumeration</td> <td>3</td> </tr> <tr> <td>enumeration</td> <td>3A</td> </tr> <tr> <td>enumeration</td> <td>3B</td> </tr> <tr> <td>enumeration</td> <td>3P</td> </tr> <tr> <td>enumeration</td> <td>3T</td> </tr> </table>	Kind	Value	pattern	([0-9A-Z-])"){1}([0-9A-Z&:] ' \\-\\. , / ° \\^\\(\\ \\)\\À È É Ì Ò Ù Ü " \\ \\ \\+)*	enumeration	3	enumeration	3A	enumeration	3B	enumeration	3P	enumeration	3T
Kind	Value														
pattern	([0-9A-Z-])"){1}([0-9A-Z&:] ' \\-\\. , / ° \\^\\(\\ \\)\\À È É Ì Ò Ù Ü " \\ \\ \\+)*														
enumeration	3														
enumeration	3A														
enumeration	3B														
enumeration	3P														
enumeration	3T														

simpleType Terreni_Urbano_Type

namespace	urn:www.agenziaentrate.gov.it:specificheTecniche:sco:p73								
type	restriction of DatoAN_Type								
facets	<table border="0"> <tr> <td>Kind</td> <td>Value</td> </tr> <tr> <td>pattern</td> <td>([0-9A-Z-])&quot;){1}([0-9A-Z&amp;:] ' \\-\\. , / ° \\^\\(\\ \\)\\À È É Ì Ò Ù Ü &quot; \\ \\ \\+)*</td> </tr> <tr> <td>enumeration</td> <td>T</td> </tr> <tr> <td>enumeration</td> <td>U</td> </tr> </table>	Kind	Value	pattern	([0-9A-Z-])"){1}([0-9A-Z&:] ' \\-\\. , / ° \\^\\(\\ \\)\\À È É Ì Ò Ù Ü " \\ \\ \\+)*	enumeration	T	enumeration	U
Kind	Value								
pattern	([0-9A-Z-])"){1}([0-9A-Z&:] ' \\-\\. , / ° \\^\\(\\ \\)\\À È É Ì Ò Ù Ü " \\ \\ \\+)*								
enumeration	T								
enumeration	U								

simpleType Tipo_Inquilino_Type

namespace	urn:www.agenziaentrate.gov.it:specificheTecniche:sco:p73												
type	restriction of DatoNP_Type												
facets	<table border="0"> <tr> <td>Kind</td> <td>Value</td> </tr> <tr> <td>pattern</td> <td>[1-9]{1}[0-9]*</td> </tr> <tr> <td>enumeration</td> <td>1</td> </tr> <tr> <td>enumeration</td> <td>2</td> </tr> <tr> <td>enumeration</td> <td>3</td> </tr> <tr> <td>enumeration</td> <td>4</td> </tr> </table>	Kind	Value	pattern	[1-9]{1}[0-9]*	enumeration	1	enumeration	2	enumeration	3	enumeration	4
Kind	Value												
pattern	[1-9]{1}[0-9]*												
enumeration	1												
enumeration	2												
enumeration	3												
enumeration	4												

simpleType Tipo_Intervento_Type

namespace	urn:www.agenziaentrate.gov.it:specificheTecniche:sco:p73																
type	restriction of DatoN1_Type																
facets	<table border="0"> <tr> <td>Kind</td> <td>Value</td> </tr> <tr> <td>pattern</td> <td>[1-9]</td> </tr> <tr> <td>enumeration</td> <td>1</td> </tr> <tr> <td>enumeration</td> <td>2</td> </tr> <tr> <td>enumeration</td> <td>3</td> </tr> <tr> <td>enumeration</td> <td>4</td> </tr> <tr> <td>enumeration</td> <td>5</td> </tr> <tr> <td>enumeration</td> <td>6</td> </tr> </table>	Kind	Value	pattern	[1-9]	enumeration	1	enumeration	2	enumeration	3	enumeration	4	enumeration	5	enumeration	6
Kind	Value																
pattern	[1-9]																
enumeration	1																
enumeration	2																
enumeration	3																
enumeration	4																
enumeration	5																
enumeration	6																

simpleType Tipo_Reddito_Da1a12_Type

namespace	urn:www.agenziaentrate.gov.it:specificheTecniche:sco:p73																				
type	restriction of DatoNP_Type																				
facets	<table border="0"> <tr> <td>Kind</td> <td>Value</td> </tr> <tr> <td>pattern</td> <td>[1-9]{1}[0-9]*</td> </tr> <tr> <td>enumeration</td> <td>1</td> </tr> <tr> <td>enumeration</td> <td>2</td> </tr> <tr> <td>enumeration</td> <td>3</td> </tr> <tr> <td>enumeration</td> <td>4</td> </tr> <tr> <td>enumeration</td> <td>5</td> </tr> <tr> <td>enumeration</td> <td>6</td> </tr> <tr> <td>enumeration</td> <td>7</td> </tr> <tr> <td>enumeration</td> <td>8</td> </tr> </table>	Kind	Value	pattern	[1-9]{1}[0-9]*	enumeration	1	enumeration	2	enumeration	3	enumeration	4	enumeration	5	enumeration	6	enumeration	7	enumeration	8
Kind	Value																				
pattern	[1-9]{1}[0-9]*																				
enumeration	1																				
enumeration	2																				
enumeration	3																				
enumeration	4																				
enumeration	5																				
enumeration	6																				
enumeration	7																				
enumeration	8																				

	enumeration	9
	enumeration	10
	enumeration	11
	enumeration	12

simpleType Tipo_Reddito_Da1a3_Type

namespace	urn:www.agenziaentrate.gov.it:specificheTecniche:sco:p73	
type	restriction of DatoN1_Type	
facets	Kind	Value
	pattern	[1-9]
	enumeration	1
	enumeration	2
	enumeration	3

simpleType Tipo_Reddito_Da1a4_Type

namespace	urn:www.agenziaentrate.gov.it:specificheTecniche:sco:p73	
type	restriction of DatoN1_Type	
facets	Kind	Value
	pattern	[1-9]
	enumeration	1
	enumeration	2
	enumeration	3
	enumeration	4

simpleType Tipo_Reddito_Da1a6_Type

namespace	urn:www.agenziaentrate.gov.it:specificheTecniche:sco:p73	
type	restriction of DatoN1_Type	
facets	Kind	Value
	pattern	[1-9]
	enumeration	1
	enumeration	2
	enumeration	3
	enumeration	4
	enumeration	5
	enumeration	6

simpleType Tipo_Reddito_Da1a8_Type

namespace	urn:www.agenziaentrate.gov.it:specificheTecniche:sco:p73	
type	restriction of DatoNP_Type	
facets	Kind	Value
	pattern	[1-9]{1}[0-9]*
	enumeration	1
	enumeration	2
	enumeration	3
	enumeration	4
	enumeration	5
	enumeration	6
	enumeration	7
	enumeration	8

simpleType Tipo_Reddito_Da1a9_Type

namespace	urn:www.agenziaentrate.gov.it:specificheTecniche:sco:p73	
type	restriction of DatoNP_Type	
facets	Kind	Value
	pattern	[1-9]{1}[0-9]*
	enumeration	1
	enumeration	2
	enumeration	3
	enumeration	4
	enumeration	5
	enumeration	6
	enumeration	7
	enumeration	8
	enumeration	9

simpleType Titolo_Terreno_Type

namespace	urn:www.agenziaentrate.gov.it:specificheTecniche:sco:p73	
type	restriction of DatoNP_Type	
facets	Kind	Value
	pattern	[1-9]{1}[0-9]*
	enumeration	1
	enumeration	2
	enumeration	3
	enumeration	4
	enumeration	5
	enumeration	6
	enumeration	7
	enumeration	10

simpleType Utilizzo_Fabbricato_Type

namespace	urn:www.agenziaentrate.gov.it:specificheTecniche:sco:p73	
type	restriction of DatoNP_Type	
facets	Kind	Value
	pattern	[1-9]{1}[0-9]*
	enumeration	1
	enumeration	2
	enumeration	3
	enumeration	4
	enumeration	5
	enumeration	8
	enumeration	9
	enumeration	10
	enumeration	11
	enumeration	12
	enumeration	14
	enumeration	15
	enumeration	16
	enumeration	17

element ElencoFonti

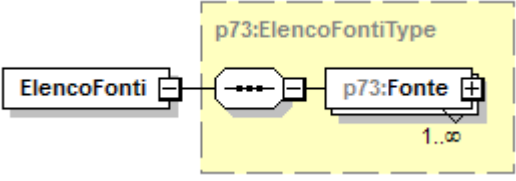
diagram	
namespace	urn:www.agenziaentrate.gov.it:specificheTecniche:sco:p73
type	p73:ElencoFontiType
children	p73:Fonte

element Sintetico730

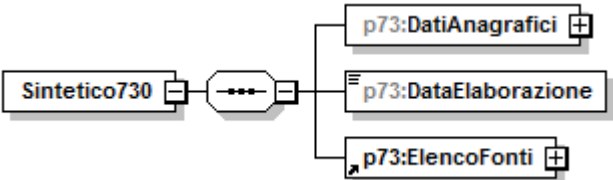
diagram	
namespace	urn:www.agenziaentrate.gov.it:specificheTecniche:sco:p73
children	p73:DatiAnagrafici p73:DataElaborazione p73:ElencoFonti

element Sintetico730/DatiAnagrafici

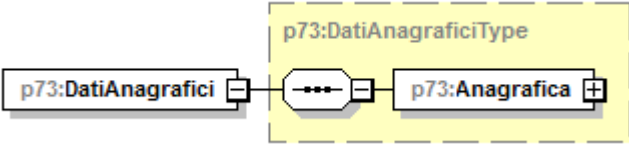
diagram	
namespace	urn:www.agenziaentrate.gov.it:specificheTecniche:sco:p73
type	p73:DatiAnagraficiType
children	p73:Anagrafica

element Sintetico730/DataElaborazione

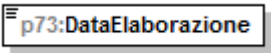
diagram					
namespace	urn:www.agenziaentrate.gov.it:specificheTecniche:sco:p73				
type	p73:DataType				
facets	<table border="1"> <thead> <tr> <th>Kind</th> <th>Value</th> </tr> </thead> <tbody> <tr> <td>pattern</td> <td>((([0-9]{1,2}[0-9]{3,4}) ([0-9]{1,2}[0-9]{3,4}) ([0-9]{1,2}[0-9]{3,4}) ([0-9]{1,2}[0-9]{3,4}) ([0-9]{1,2}[0-9]{3,4}) ([0-9]{1,2}[0-9]{3,4}) ([0-9]{1,2}[0-9]{3,4}) ([0-9]{1,2}[0-9]{3,4}) ([0-9]{1,2}[0-9]{3,4}) ([0-9]{1,2}[0-9]{3,4})) ([0-9]{1,2}[0-9]{3,4}) ([0-9]{1,2}[0-9]{3,4}) ([0-9]{1,2}[0-9]{3,4}) ([0-9]{1,2}[0-9]{3,4}) ([0-9]{1,2}[0-9]{3,4}) ([0-9]{1,2}[0-9]{3,4}) ([0-9]{1,2}[0-9]{3,4}) ([0-9]{1,2}[0-9]{3,4}) ([0-9]{1,2}[0-9]{3,4}))</td> </tr> </tbody> </table>	Kind	Value	pattern	((([0-9]{1,2}[0-9]{3,4}) ([0-9]{1,2}[0-9]{3,4}) ([0-9]{1,2}[0-9]{3,4}) ([0-9]{1,2}[0-9]{3,4}) ([0-9]{1,2}[0-9]{3,4}) ([0-9]{1,2}[0-9]{3,4}) ([0-9]{1,2}[0-9]{3,4}) ([0-9]{1,2}[0-9]{3,4}) ([0-9]{1,2}[0-9]{3,4}) ([0-9]{1,2}[0-9]{3,4})) ([0-9]{1,2}[0-9]{3,4}) ([0-9]{1,2}[0-9]{3,4}) ([0-9]{1,2}[0-9]{3,4}) ([0-9]{1,2}[0-9]{3,4}) ([0-9]{1,2}[0-9]{3,4}) ([0-9]{1,2}[0-9]{3,4}) ([0-9]{1,2}[0-9]{3,4}) ([0-9]{1,2}[0-9]{3,4}) ([0-9]{1,2}[0-9]{3,4}))
Kind	Value				
pattern	((([0-9]{1,2}[0-9]{3,4}) ([0-9]{1,2}[0-9]{3,4}) ([0-9]{1,2}[0-9]{3,4}) ([0-9]{1,2}[0-9]{3,4}) ([0-9]{1,2}[0-9]{3,4}) ([0-9]{1,2}[0-9]{3,4}) ([0-9]{1,2}[0-9]{3,4}) ([0-9]{1,2}[0-9]{3,4}) ([0-9]{1,2}[0-9]{3,4}) ([0-9]{1,2}[0-9]{3,4})) ([0-9]{1,2}[0-9]{3,4}) ([0-9]{1,2}[0-9]{3,4}) ([0-9]{1,2}[0-9]{3,4}) ([0-9]{1,2}[0-9]{3,4}) ([0-9]{1,2}[0-9]{3,4}) ([0-9]{1,2}[0-9]{3,4}) ([0-9]{1,2}[0-9]{3,4}) ([0-9]{1,2}[0-9]{3,4}) ([0-9]{1,2}[0-9]{3,4}))				

complexType AnagraficaType

diagram	
namespace	urn:www.agenziaentrate.gov.it:specificheTecniche:sco:p73
children	p73:CodiceFiscale p73:Nome p73:Cognome

element AnagraficaType/CodiceFiscale

diagram	
namespace	urn:www.agenziaentrate.gov.it:specificheTecniche:sco:p73
type	xs:string

element AnagraficaType/Nome

diagram	
namespace	urn:www.agenziaentrate.gov.it:specificheTecniche:sco:p73
type	xs:string

element AnagraficaType/Cognome

diagram	
namespace	urn:www.agenziaentrate.gov.it:specificheTecniche:sco:p73
type	xs:string

complexType DatiAnagraficiType

diagram	
namespace	urn:www.agenziaentrate.gov.it:specificheTecniche:sco:p73
children	p73:Anagrafica

element **DatiAnagraficiType/Anagrafica**

diagram	
namespace	urn:www.agenziaentrate.gov.it:specificheTecniche:sco:p73
type	p73:AnagraficaType
children	p73:CodiceFiscale p73:Nome p73:Cognome

complexType **DettaglioFonteType**

diagram	
namespace	urn:www.agenziaentrate.gov.it:specificheTecniche:sco:p73
children	p73:Testata p73:TestataImporto p73:TestataUtilizzo p73:Dettaglio

element **DettaglioFonteType/Testata**

diagram	
namespace	urn:www.agenziaentrate.gov.it:specificheTecniche:sco:p73
type	xs:string

element **DettaglioFonteType/TestataImporto**

diagram	
namespace	urn:www.agenziaentrate.gov.it:specificheTecniche:sco:p73
type	xs:string

element DettaglioFonteType/TestataUtilizzo

diagram	
namespace	urn:www.agenziaentrate.gov.it:specificheTecniche:sco:p73
type	xs:string

element DettaglioFonteType/Dettaglio

diagram	
namespace	urn:www.agenziaentrate.gov.it:specificheTecniche:sco:p73
type	p73:DettaglioType
children	p73:Contenuto p73:Importo p73:Utilizzo

complexType DettaglioType

diagram	
namespace	urn:www.agenziaentrate.gov.it:specificheTecniche:sco:p73
children	p73:Contenuto p73:Importo p73:Utilizzo

element DettaglioType/Contenuto

diagram	
namespace	urn:www.agenziaentrate.gov.it:specificheTecniche:sco:p73
type	xs:string

element DettaglioType/Importo

diagram	
---------	--

namespace	urn:www.agenziaentrate.gov.it:specificheTecniche:sco:p73
type	p73:ImportoType
facets	Kind Value pattern $(\backslash-[1-9] [1-9])[0-9]^*$

element **DettaglioType/Utilizzo**

diagram	
namespace	urn:www.agenziaentrate.gov.it:specificheTecniche:sco:p73
type	xs:string

complexType **ElencoFontiType**

diagram	
namespace	urn:www.agenziaentrate.gov.it:specificheTecniche:sco:p73
children	p73:Fonte

element **ElencoFontiType/Fonte**

diagram	
namespace	urn:www.agenziaentrate.gov.it:specificheTecniche:sco:p73
type	p73:FonteType
children	p73:TipoFonte p73:Verifica p73:DettaglioFonte

complexType **FonteType**

diagram	
---------	--

namespace	urn:www.agenziaentrate.gov.it:specificheTecniche:sco:p73
children	p73:TipoFonte p73:Verifica p73:DettaglioFonte

element FonteType/TipoFonte

diagram	
namespace	urn:www.agenziaentrate.gov.it:specificheTecniche:sco:p73
type	xs:string

element FonteType/Verifica

diagram	
namespace	urn:www.agenziaentrate.gov.it:specificheTecniche:sco:p73
type	xs:int

element FonteType/DettaglioFonte

diagram	
namespace	urn:www.agenziaentrate.gov.it:specificheTecniche:sco:p73
type	p73:DettaglioFonteType
children	p73:Testata p73:TestataImporto p73:TestataUtilizzo p73:Dettaglio

simpleType DataType

namespace	urn:www.agenziaentrate.gov.it:specificheTecniche:sco:p73				
type	restriction of xs:string				
facets	<table border="1"> <thead> <tr> <th>Kind</th> <th>Value</th> </tr> </thead> <tbody> <tr> <td>pattern</td> <td>((([0-9][1-9][12][0-9][301])(0[13578][1012](\d{4})) ([0][1-9][12][0-9][30](0[469][11](\d{4})) ([0][1-9][1][0-9][2[0-8])(02)(\d{4})) ((29)(02)([02468][048]00)) ((29)(02)([13579][26]00)) ((29)(02)([0-9][0-9][0][48])) ((29)(02)([0-9][0-9][2468][048])) ((29)(02)([0-9][0-9][13579][26]))))</td> </tr> </tbody> </table>	Kind	Value	pattern	((([0-9][1-9][12][0-9][301])(0[13578][1012](\d{4})) ([0][1-9][12][0-9][30](0[469][11](\d{4})) ([0][1-9][1][0-9][2[0-8])(02)(\d{4})) ((29)(02)([02468][048]00)) ((29)(02)([13579][26]00)) ((29)(02)([0-9][0-9][0][48])) ((29)(02)([0-9][0-9][2468][048])) ((29)(02)([0-9][0-9][13579][26]))))
Kind	Value				
pattern	((([0-9][1-9][12][0-9][301])(0[13578][1012](\d{4})) ([0][1-9][12][0-9][30](0[469][11](\d{4})) ([0][1-9][1][0-9][2[0-8])(02)(\d{4})) ((29)(02)([02468][048]00)) ((29)(02)([13579][26]00)) ((29)(02)([0-9][0-9][0][48])) ((29)(02)([0-9][0-9][2468][048])) ((29)(02)([0-9][0-9][13579][26]))))				

simpleType DatoCFTYPE

namespace	urn:www.agenziaentrate.gov.it:specificheTecniche:sco:p73				
type	restriction of xs:string				
facets	<table border="1"> <tr> <td>Kind</td> <td>Value</td> </tr> <tr> <td>pattern</td> <td>[0-9]{11}[A-Z]{6}[0-9LMNPQRSTUVWXYZ]{2}[A-Z]{1}[0-9LMNPQRSTUVWXYZ]{2}[A-Z]{1}[0-9LMNPQRSTUVWXYZ]{3}[A-Z]{1}</td> </tr> </table>	Kind	Value	pattern	[0-9]{11}[A-Z]{6}[0-9LMNPQRSTUVWXYZ]{2}[A-Z]{1}[0-9LMNPQRSTUVWXYZ]{2}[A-Z]{1}[0-9LMNPQRSTUVWXYZ]{3}[A-Z]{1}
Kind	Value				
pattern	[0-9]{11}[A-Z]{6}[0-9LMNPQRSTUVWXYZ]{2}[A-Z]{1}[0-9LMNPQRSTUVWXYZ]{2}[A-Z]{1}[0-9LMNPQRSTUVWXYZ]{3}[A-Z]{1}				

simpleType ImportoType

namespace	urn:www.agenziaentrate.gov.it:specificheTecniche:sco:p73				
type	restriction of xs:string				
facets	<table border="1"> <tr> <td>Kind</td> <td>Value</td> </tr> <tr> <td>pattern</td> <td>(\-[1-9] [1-9])[0-9]*</td> </tr> </table>	Kind	Value	pattern	(\-[1-9] [1-9])[0-9]*
Kind	Value				
pattern	(\-[1-9] [1-9])[0-9]*				

simpleType DatoAN_Type

namespace	urn:www.agenziaentrate.gov.it:specificheTecniche:common				
type	restriction of xs:string				
facets	<table border="1"> <tr> <td>Kind</td> <td>Value</td> </tr> <tr> <td>pattern</td> <td>([0-9A-Z\-_]\&quot;){1}([0-9A-Z&amp;] \- \., / \^ \(\) À É Ì Ò Ù Û &quot; \\ / +)*</td> </tr> </table>	Kind	Value	pattern	([0-9A-Z\-_]\"){1}([0-9A-Z&] \- \., / \^ \(\) À É Ì Ò Ù Û " \\ / +)*
Kind	Value				
pattern	([0-9A-Z\-_]\"){1}([0-9A-Z&] \- \., / \^ \(\) À É Ì Ò Ù Û " \\ / +)*				

simpleType DatoCB12_Type

namespace	urn:www.agenziaentrate.gov.it:specificheTecniche:common				
type	restriction of xs:byte				
facets	<table border="1"> <tr> <td>Kind</td> <td>Value</td> </tr> <tr> <td>pattern</td> <td>[10]{12}</td> </tr> </table>	Kind	Value	pattern	[10]{12}
Kind	Value				
pattern	[10]{12}				

simpleType DatoCB_Type

namespace	urn:www.agenziaentrate.gov.it:specificheTecniche:common				
type	restriction of xs:byte				
facets	<table border="1"> <tr> <td>Kind</td> <td>Value</td> </tr> <tr> <td>pattern</td> <td>[01]</td> </tr> </table>	Kind	Value	pattern	[01]
Kind	Value				
pattern	[01]				

simpleType DatoCF_Type

namespace	urn:www.agenziaentrate.gov.it:specificheTecniche:common				
type	restriction of xs:string				
facets	<table border="1"> <tr> <td>Kind</td> <td>Value</td> </tr> <tr> <td>pattern</td> <td>[0-9]{11}[A-Z]{6}[0-9LMNPQRSTUVWXYZ]{2}[A-Z]{1}[0-9LMNPQRSTUVWXYZ]{2}[A-Z]{1}[0-9LMNPQRSTUVWXYZ]{3}[A-Z]{1}</td> </tr> </table>	Kind	Value	pattern	[0-9]{11}[A-Z]{6}[0-9LMNPQRSTUVWXYZ]{2}[A-Z]{1}[0-9LMNPQRSTUVWXYZ]{2}[A-Z]{1}[0-9LMNPQRSTUVWXYZ]{3}[A-Z]{1}
Kind	Value				
pattern	[0-9]{11}[A-Z]{6}[0-9LMNPQRSTUVWXYZ]{2}[A-Z]{1}[0-9LMNPQRSTUVWXYZ]{2}[A-Z]{1}[0-9LMNPQRSTUVWXYZ]{3}[A-Z]{1}				

simpleType DatoCN_Type

namespace	urn:www.agenziaentrate.gov.it:specificheTecniche:common				
type	restriction of xs:string				
facets	<table border="1"> <tr> <td>Kind</td> <td>Value</td> </tr> <tr> <td>pattern</td> <td>[0-9]{11}</td> </tr> </table>	Kind	Value	pattern	[0-9]{11}
Kind	Value				
pattern	[0-9]{11}				

simpleType DatoCP_Type

namespace	urn:www.agenziaentrate.gov.it:specificheTecniche:common				
type	restriction of xs:string				
facets	<table border="1"> <tr> <td>Kind</td> <td>Value</td> </tr> <tr> <td>pattern</td> <td>[0-9]{5}</td> </tr> </table>	Kind	Value	pattern	[0-9]{5}
Kind	Value				
pattern	[0-9]{5}				

simpleType DatoD6_Type

namespace	urn:www.agenziaentrate.gov.it:specificheTecniche:common				
type	restriction of xs:string				
facets	<table border="1"> <tr> <td>Kind</td> <td>Value</td> </tr> <tr> <td>pattern</td> <td>((0[0-9]) (1[0-2]))((19 20)[0-9][0-9])</td> </tr> </table>	Kind	Value	pattern	((0[0-9]) (1[0-2]))((19 20)[0-9][0-9])
Kind	Value				
pattern	((0[0-9]) (1[0-2]))((19 20)[0-9][0-9])				

simpleType DatoDA_Type

namespace	urn:www.agenziaentrate.gov.it:specificheTecniche:common				
type	restriction of xs:string				
facets	<table border="1"> <tr> <td>Kind</td> <td>Value</td> </tr> <tr> <td>pattern</td> <td>(18 19 20)[0-9]{2}</td> </tr> </table>	Kind	Value	pattern	(18 19 20)[0-9]{2}
Kind	Value				
pattern	(18 19 20)[0-9]{2}				

simpleType DatoDN_Type

namespace	urn:www.agenziaentrate.gov.it:specificheTecniche:common				
type	restriction of xs:string				
facets	<table border="1"> <tr> <td>Kind</td> <td>Value</td> </tr> <tr> <td>pattern</td> <td>((([0-9][1-9][12][0-9][301]) (0[13578][1012](\d{4}))) ((([0-9][1-9][12][0-9][30](0[469][11](\d{4})) ((0[1-9][1[0-9]]2[0-8])(02)(\d{4}))) ((29)(02)([02468][048]00)) ((29)(02)([13579][26]00)) ((29)(02)([0-9][0-9][0][48])) ((29)(02)([0-9][0-9][2468][048])) ((29)(02)([0-9][0-9][13579][26]))))</td> </tr> </table>	Kind	Value	pattern	((([0-9][1-9][12][0-9][301]) (0[13578][1012](\d{4}))) ((([0-9][1-9][12][0-9][30](0[469][11](\d{4})) ((0[1-9][1[0-9]]2[0-8])(02)(\d{4}))) ((29)(02)([02468][048]00)) ((29)(02)([13579][26]00)) ((29)(02)([0-9][0-9][0][48])) ((29)(02)([0-9][0-9][2468][048])) ((29)(02)([0-9][0-9][13579][26]))))
Kind	Value				
pattern	((([0-9][1-9][12][0-9][301]) (0[13578][1012](\d{4}))) ((([0-9][1-9][12][0-9][30](0[469][11](\d{4})) ((0[1-9][1[0-9]]2[0-8])(02)(\d{4}))) ((29)(02)([02468][048]00)) ((29)(02)([13579][26]00)) ((29)(02)([0-9][0-9][0][48])) ((29)(02)([0-9][0-9][2468][048])) ((29)(02)([0-9][0-9][13579][26]))))				

simpleType DatoDT_Type

namespace	urn:www.agenziaentrate.gov.it:specificheTecniche:common				
type	restriction of xs:string				
facets	<table border="1"> <tr> <td>Kind</td> <td>Value</td> </tr> <tr> <td>pattern</td> <td>((([0-9][1-9][12][0-9][301]) (0[13578][1012](\d{4}))) ((([0-9][1-9][12][0-9][30](0[469][11](\d{4})) ((0[1-9][1[0-9]]2[0-8])(02)(\d{4}))) ((29)(02)([02468][048]00)) ((29)(02)([13579][26]00)) ((29)(02)([0-9][0-9][0][48])) ((29)(02)([0-9][0-9][2468][048])) ((29)(02)([0-9][0-9][13579][26]))))</td> </tr> </table>	Kind	Value	pattern	((([0-9][1-9][12][0-9][301]) (0[13578][1012](\d{4}))) ((([0-9][1-9][12][0-9][30](0[469][11](\d{4})) ((0[1-9][1[0-9]]2[0-8])(02)(\d{4}))) ((29)(02)([02468][048]00)) ((29)(02)([13579][26]00)) ((29)(02)([0-9][0-9][0][48])) ((29)(02)([0-9][0-9][2468][048])) ((29)(02)([0-9][0-9][13579][26]))))
Kind	Value				
pattern	((([0-9][1-9][12][0-9][301]) (0[13578][1012](\d{4}))) ((([0-9][1-9][12][0-9][30](0[469][11](\d{4})) ((0[1-9][1[0-9]]2[0-8])(02)(\d{4}))) ((29)(02)([02468][048]00)) ((29)(02)([13579][26]00)) ((29)(02)([0-9][0-9][0][48])) ((29)(02)([0-9][0-9][2468][048])) ((29)(02)([0-9][0-9][13579][26]))))				

simpleType DatoEM_Type

namespace	urn:www.agenziaentrate.gov.it:specificheTecniche:common				
type	restriction of xs:string				
facets	<table border="1"> <tr> <td>Kind</td> <td>Value</td> </tr> <tr> <td>pattern</td> <td>[a-zA-Z0-9._%'\-&quot;?^~=]+@[a-zA-Z0-9.\-]+\.[a-zA-Z]{2,4}</td> </tr> </table>	Kind	Value	pattern	[a-zA-Z0-9._%'\-"?^~=]+@[a-zA-Z0-9.\-]+\.[a-zA-Z]{2,4}
Kind	Value				
pattern	[a-zA-Z0-9._%'\-"?^~=]+@[a-zA-Z0-9.\-]+\.[a-zA-Z]{2,4}				

simpleType DatoGA_Type

namespace	urn:www.agenziaentrate.gov.it:specificheTecniche:common
-----------	---

type	restriction of xs:string				
facets	<table border="1"> <tr> <td>Kind</td> <td>Value</td> </tr> <tr> <td>pattern</td> <td>[1-9]{1}((1-9)[0-9]) ((12)[0-9][0-9]) (3[0-5][0-9]) (36[0-5])</td> </tr> </table>	Kind	Value	pattern	[1-9]{1}((1-9)[0-9]) ((12)[0-9][0-9]) (3[0-5][0-9]) (36[0-5])
Kind	Value				
pattern	[1-9]{1}((1-9)[0-9]) ((12)[0-9][0-9]) (3[0-5][0-9]) (36[0-5])				

simpleType DatoN1_Type

namespace	urn:www.agenziaentrate.gov.it:specificheTecniche:common				
type	restriction of xs:string				
facets	<table border="1"> <tr> <td>Kind</td> <td>Value</td> </tr> <tr> <td>pattern</td> <td>[1-9]</td> </tr> </table>	Kind	Value	pattern	[1-9]
Kind	Value				
pattern	[1-9]				

simpleType DatoNP_Type

namespace	urn:www.agenziaentrate.gov.it:specificheTecniche:common				
type	restriction of xs:string				
facets	<table border="1"> <tr> <td>Kind</td> <td>Value</td> </tr> <tr> <td>pattern</td> <td>[1-9]{1}[0-9]*</td> </tr> </table>	Kind	Value	pattern	[1-9]{1}[0-9]*
Kind	Value				
pattern	[1-9]{1}[0-9]*				

simpleType DatoNU_Type

namespace	urn:www.agenziaentrate.gov.it:specificheTecniche:common				
type	restriction of xs:string				
facets	<table border="1"> <tr> <td>Kind</td> <td>Value</td> </tr> <tr> <td>pattern</td> <td>(\-[1-9]) [1-9][0-9]*</td> </tr> </table>	Kind	Value	pattern	(\-[1-9]) [1-9][0-9]*
Kind	Value				
pattern	(\-[1-9]) [1-9][0-9]*				

simpleType DatoPC_Type

namespace	urn:www.agenziaentrate.gov.it:specificheTecniche:common				
type	restriction of xs:string				
facets	<table border="1"> <tr> <td>Kind</td> <td>Value</td> </tr> <tr> <td>pattern</td> <td>[0-9]?[0-9](,\d{1,3})? 100,(0{1,3})?</td> </tr> </table>	Kind	Value	pattern	[0-9]?[0-9](,\d{1,3})? 100,(0{1,3})?
Kind	Value				
pattern	[0-9]?[0-9](,\d{1,3})? 100,(0{1,3})?				

simpleType DatoPI_Type

namespace	urn:www.agenziaentrate.gov.it:specificheTecniche:common				
type	restriction of xs:string				
facets	<table border="1"> <tr> <td>Kind</td> <td>Value</td> </tr> <tr> <td>pattern</td> <td>[0-7][0-9]{10}</td> </tr> </table>	Kind	Value	pattern	[0-7][0-9]{10}
Kind	Value				
pattern	[0-7][0-9]{10}				

simpleType DatoQU_Type

namespace	urn:www.agenziaentrate.gov.it:specificheTecniche:common				
type	restriction of xs:string				
facets	<table border="1"> <tr> <td>Kind</td> <td>Value</td> </tr> <tr> <td>pattern</td> <td>[0-9]+(,[0-9]{1,5})?</td> </tr> </table>	Kind	Value	pattern	[0-9]+(,[0-9]{1,5})?
Kind	Value				
pattern	[0-9]+(,[0-9]{1,5})?				

simpleType DatoTL_Type

namespace	urn:www.agenziaentrate.gov.it:specificheTecniche:common
type	restriction of xs:string
facets	Kind Value pattern [0-9]*

simpleType DatoVP_Type

namespace	urn:www.agenziaentrate.gov.it:specificheTecniche:common
type	restriction of xs:string
facets	Kind Value pattern [0-9]+,[0-9]{2}

element Documento

diagram					
namespace	urn:www.agenziaentrate.gov.it:specificheTecniche:common				
type	Documento_Type				
attributes	Name identificativo	Type Identificativo_Type	Use required	Default	Fixed

complexType Documento_Type

diagram					
namespace	urn:www.agenziaentrate.gov.it:specificheTecniche:common				
attributes	Name identificativo	Type Identificativo_Type	Use required	Default	Fixed

attribute Documento_Type/@identificativo

type	Identificativo_Type				
facets	Kind Value pattern [0-9]{4}[1-9] [0-9]{3}[1-9][0-9] [0-9]{2}[1-9][0-9]{2} [0-9][1-9][0-9]{3} [1-9][0-9]{4}				

simpleType Identificativo_Type

namespace	urn:www.agenziaentrate.gov.it:specificheTecniche:common				
type	restriction of xs:string				
facets	<table border="1"> <tr> <td>Kind</td> <td>Value</td> </tr> <tr> <td>pattern</td> <td>[0-9]{4}[1-9] [0-9]{3}[1-9] [0-9]{2}[1-9] [0-9]{2} [0-9]{1-9} [0-9]{3} [1-9][0-9]{4}</td> </tr> </table>	Kind	Value	pattern	[0-9]{4}[1-9] [0-9]{3}[1-9] [0-9]{2}[1-9] [0-9]{2} [0-9]{1-9} [0-9]{3} [1-9][0-9]{4}
Kind	Value				
pattern	[0-9]{4}[1-9] [0-9]{3}[1-9] [0-9]{2}[1-9] [0-9]{2} [0-9]{1-9} [0-9]{3} [1-9][0-9]{4}				

complexType Dati_Anagrafici_Type

diagram	
namespace	urn:www.agenziaentrate.gov.it:specificheTecniche:sco:common
children	Cognome Nome Sesso DataNascita ComuneNascita ProvinciaNascita

element Dati_Anagrafici_Type/Cognome

diagram					
namespace	urn:www.agenziaentrate.gov.it:specificheTecniche:sco:common				
type	DatoAN_Type				
facets	<table border="1"> <tr> <td>Kind</td> <td>Value</td> </tr> <tr> <td>pattern</td> <td>(([0-9A-Z-] \&quot;){1}([0-9A-Z&amp;#39; ! - \., / ° °\^\(\ \)À È É Ì Ò Ù Û &quot; \ \ /+)*</td> </tr> </table>	Kind	Value	pattern	(([0-9A-Z-] \"){1}([0-9A-Z&#39; ! - \., / ° °\^\(\ \)À È É Ì Ò Ù Û " \ \ /+)*
Kind	Value				
pattern	(([0-9A-Z-] \"){1}([0-9A-Z&#39; ! - \., / ° °\^\(\ \)À È É Ì Ò Ù Û " \ \ /+)*				

element Dati_Anagrafici_Type/Nome

diagram					
namespace	urn:www.agenziaentrate.gov.it:specificheTecniche:sco:common				
type	DatoAN_Type				
facets	<table border="1"> <tr> <td>Kind</td> <td>Value</td> </tr> <tr> <td>pattern</td> <td>(([0-9A-Z-] \&quot;){1}([0-9A-Z&amp;#39; ! - \., / ° °\^\(\ \)À È É Ì Ò Ù Û &quot; \ \ /+)*</td> </tr> </table>	Kind	Value	pattern	(([0-9A-Z-] \"){1}([0-9A-Z&#39; ! - \., / ° °\^\(\ \)À È É Ì Ò Ù Û " \ \ /+)*
Kind	Value				
pattern	(([0-9A-Z-] \"){1}([0-9A-Z&#39; ! - \., / ° °\^\(\ \)À È É Ì Ò Ù Û " \ \ /+)*				

element Dati_Anagrafici_Type/Sesso

diagram	
---------	--

namespace	urn:www.agenziaentrate.gov.it:specificheTecniche:sco:common								
type	Sesso_Type								
facets	<table border="0"> <tr> <td>Kind</td> <td>Value</td> </tr> <tr> <td>pattern</td> <td>(([0-9A-Z-])&quot;){1}([0-9A-Z&amp;:] ' \\-\\. , / ^ \\^ \\(\\) À É È Ì Ò Ù Û &quot; \\N \\+)*</td> </tr> <tr> <td>enumeration</td> <td>M</td> </tr> <tr> <td>enumeration</td> <td>F</td> </tr> </table>	Kind	Value	pattern	(([0-9A-Z-])"){1}([0-9A-Z&:] ' \\-\\. , / ^ \\^ \\(\\) À É È Ì Ò Ù Û " \\N \\+)*	enumeration	M	enumeration	F
Kind	Value								
pattern	(([0-9A-Z-])"){1}([0-9A-Z&:] ' \\-\\. , / ^ \\^ \\(\\) À É È Ì Ò Ù Û " \\N \\+)*								
enumeration	M								
enumeration	F								

element Dati_Anagrafici_Type/DataNascita

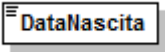
diagram					
namespace	urn:www.agenziaentrate.gov.it:specificheTecniche:sco:common				
type	DatoDT_Type				
facets	<table border="0"> <tr> <td>Kind</td> <td>Value</td> </tr> <tr> <td>pattern</td> <td>((([0-9]{1-9}){12}([0-9]{3} 01)))(0[13578][10 12](\\d{4}))(((0[1-9]) 12 0-9 30)(0[469] 11)(\\d{4}))(((0[1-9] 1[0-9] 2[0-8])(02)(\\d{4})) ((29)(02)([02468][048]00)) ((29)(02)([13579][26]00)) ((29)(02)([0-9][0-9][0][48])) ((29)(02)([0-9][0-9][2468][048])) ((29)(02)([0-9][0-9][13579][26]))))</td> </tr> </table>	Kind	Value	pattern	((([0-9]{1-9}){12}([0-9]{3} 01)))(0[13578][10 12](\\d{4}))(((0[1-9]) 12 0-9 30)(0[469] 11)(\\d{4}))(((0[1-9] 1[0-9] 2[0-8])(02)(\\d{4})) ((29)(02)([02468][048]00)) ((29)(02)([13579][26]00)) ((29)(02)([0-9][0-9][0][48])) ((29)(02)([0-9][0-9][2468][048])) ((29)(02)([0-9][0-9][13579][26]))))
Kind	Value				
pattern	((([0-9]{1-9}){12}([0-9]{3} 01)))(0[13578][10 12](\\d{4}))(((0[1-9]) 12 0-9 30)(0[469] 11)(\\d{4}))(((0[1-9] 1[0-9] 2[0-8])(02)(\\d{4})) ((29)(02)([02468][048]00)) ((29)(02)([13579][26]00)) ((29)(02)([0-9][0-9][0][48])) ((29)(02)([0-9][0-9][2468][048])) ((29)(02)([0-9][0-9][13579][26]))))				

element Dati_Anagrafici_Type/ComuneNascita

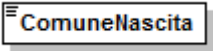
diagram					
namespace	urn:www.agenziaentrate.gov.it:specificheTecniche:sco:common				
type	DatoAN_Type				
facets	<table border="0"> <tr> <td>Kind</td> <td>Value</td> </tr> <tr> <td>pattern</td> <td>(([0-9A-Z-])&quot;){1}([0-9A-Z&amp;:] ' \\-\\. , / ^ \\^ \\(\\) À É È Ì Ò Ù Û &quot; \\N \\+)*</td> </tr> </table>	Kind	Value	pattern	(([0-9A-Z-])"){1}([0-9A-Z&:] ' \\-\\. , / ^ \\^ \\(\\) À É È Ì Ò Ù Û " \\N \\+)*
Kind	Value				
pattern	(([0-9A-Z-])"){1}([0-9A-Z&:] ' \\-\\. , / ^ \\^ \\(\\) À É È Ì Ò Ù Û " \\N \\+)*				

element Dati_Anagrafici_Type/ProvinciaNascita

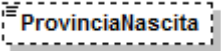
diagram	
namespace	urn:www.agenziaentrate.gov.it:specificheTecniche:sco:common
type	PN_Type

complexType **Dati_Sottoscrittore_Type**

diagram	
namespace	urn:www.agenziaentrate.gov.it:specificheTecniche:sco:common
children	CodiceFiscale CodiceCarica CodiceFiscaleSocieta DatiAnagrafici ResidenzaEstera Telefono DataCarica InizioProcedura ProceduraNonTerminata FineProcedura

element **Dati_Sottoscrittore_Type/CodiceFiscale**

diagram					
namespace	urn:www.agenziaentrate.gov.it:specificheTecniche:sco:common				
type	DatoCF_Type				
facets	<table border="1"> <thead> <tr> <th>Kind</th> <th>Value</th> </tr> </thead> <tbody> <tr> <td>pattern</td> <td>[0-9]{11}[A-Z]{6}[0-9LMNPQRSTUUV]{2}[A-Z]{1}[0-9LMNPQRSTUUV]{2}[A-Z]{1}[0-9LMNPQRSTUUV]{3}[A-Z]{1}</td> </tr> </tbody> </table>	Kind	Value	pattern	[0-9]{11}[A-Z]{6}[0-9LMNPQRSTUUV]{2}[A-Z]{1}[0-9LMNPQRSTUUV]{2}[A-Z]{1}[0-9LMNPQRSTUUV]{3}[A-Z]{1}
Kind	Value				
pattern	[0-9]{11}[A-Z]{6}[0-9LMNPQRSTUUV]{2}[A-Z]{1}[0-9LMNPQRSTUUV]{2}[A-Z]{1}[0-9LMNPQRSTUUV]{3}[A-Z]{1}				

element **Dati_Sottoscrittore_Type/CodiceCarica**

diagram																					
namespace	urn:www.agenziaentrate.gov.it:specificheTecniche:sco:common																				
type	Codice_Carica_Type																				
facets	<table border="1"> <thead> <tr> <th>Kind</th> <th>Value</th> </tr> </thead> <tbody> <tr> <td>pattern</td> <td>[1-9]{1}[0-9]*</td> </tr> <tr> <td>enumeration</td> <td>1</td> </tr> <tr> <td>enumeration</td> <td>2</td> </tr> <tr> <td>enumeration</td> <td>3</td> </tr> <tr> <td>enumeration</td> <td>4</td> </tr> <tr> <td>enumeration</td> <td>5</td> </tr> <tr> <td>enumeration</td> <td>6</td> </tr> <tr> <td>enumeration</td> <td>7</td> </tr> <tr> <td>enumeration</td> <td>8</td> </tr> </tbody> </table>	Kind	Value	pattern	[1-9]{1}[0-9]*	enumeration	1	enumeration	2	enumeration	3	enumeration	4	enumeration	5	enumeration	6	enumeration	7	enumeration	8
Kind	Value																				
pattern	[1-9]{1}[0-9]*																				
enumeration	1																				
enumeration	2																				
enumeration	3																				
enumeration	4																				
enumeration	5																				
enumeration	6																				
enumeration	7																				
enumeration	8																				

	enumeration	9
	enumeration	10
	enumeration	11
	enumeration	12
	enumeration	13
	enumeration	14
	enumeration	15

element Dati_Sottoscrittore_Type/CodiceFiscaleSocieta

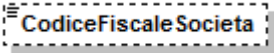
diagram	
namespace	urn:www.agenziaentrate.gov.it:specificheTecniche:sco:common
type	DatoCN Type
facets	Kind Value pattern [0-9]{11}

element Dati_Sottoscrittore_Type/DatiAnagrafici

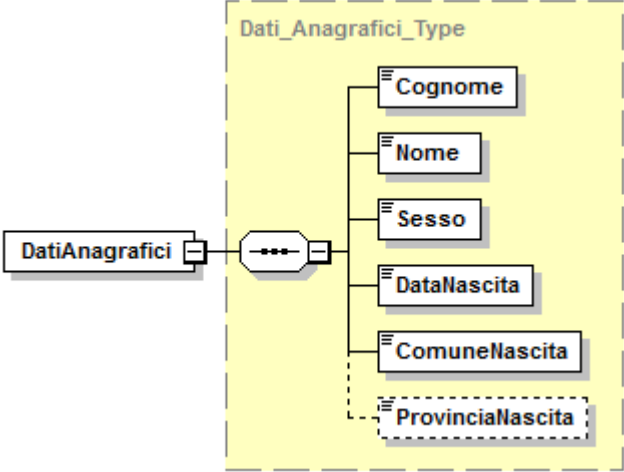
diagram	
namespace	urn:www.agenziaentrate.gov.it:specificheTecniche:sco:common
type	Dati_Anagrafici Type
children	Cognome Nome Sesso DataNascita ComuneNascita ProvinciaNascita

element **Dati_Sottoscrittore_Type/ResidenzaEstera**

diagram	
namespace	urn:www.agenziaentrate.gov.it:specificheTecniche:sco:common
type	Residenza_Estera_Type
children	CodiceStatoEstero StatoFederato LocalitaEstero IndirizzoEstero

element **Dati_Sottoscrittore_Type/Telefono**

diagram					
namespace	urn:www.agenziaentrate.gov.it:specificheTecniche:sco:common				
type	DatoTL_Type				
facets	<table border="1"> <thead> <tr> <th>Kind</th> <th>Value</th> </tr> </thead> <tbody> <tr> <td>pattern</td> <td>[0-9]*</td> </tr> </tbody> </table>	Kind	Value	pattern	[0-9]*
Kind	Value				
pattern	[0-9]*				

element **Dati_Sottoscrittore_Type/DataCarica**

diagram					
namespace	urn:www.agenziaentrate.gov.it:specificheTecniche:sco:common				
type	DatoDT_Type				
facets	<table border="1"> <thead> <tr> <th>Kind</th> <th>Value</th> </tr> </thead> <tbody> <tr> <td>pattern</td> <td>((([0-9]{1,12}[0-9]{3,01})(0[13578][10]12\d{4})) ([0]{1,9}[12][0-9]{30}(0[469][11]\d{4})) ([0]{1,9}[1][0-9]{2[0-8]}(02\d{4})) ((29)(02)[02468][048]00)) ((29)(02)[13579][26]00)) ((29)(02)[0-9][0-9][0][48])) ((29)(02)[0-9][0-9][2468][048])) ((29)(02)[0-9][0-9][13579][26]))</td> </tr> </tbody> </table>	Kind	Value	pattern	((([0-9]{1,12}[0-9]{3,01})(0[13578][10]12\d{4})) ([0]{1,9}[12][0-9]{30}(0[469][11]\d{4})) ([0]{1,9}[1][0-9]{2[0-8]}(02\d{4})) ((29)(02)[02468][048]00)) ((29)(02)[13579][26]00)) ((29)(02)[0-9][0-9][0][48])) ((29)(02)[0-9][0-9][2468][048])) ((29)(02)[0-9][0-9][13579][26]))
Kind	Value				
pattern	((([0-9]{1,12}[0-9]{3,01})(0[13578][10]12\d{4})) ([0]{1,9}[12][0-9]{30}(0[469][11]\d{4})) ([0]{1,9}[1][0-9]{2[0-8]}(02\d{4})) ((29)(02)[02468][048]00)) ((29)(02)[13579][26]00)) ((29)(02)[0-9][0-9][0][48])) ((29)(02)[0-9][0-9][2468][048])) ((29)(02)[0-9][0-9][13579][26]))				

element **Dati_Sottoscrittore_Type/InizioProcedura**

diagram					
namespace	urn:www.agenziaentrate.gov.it:specificheTecniche:sco:common				
type	DatoDT_Type				
facets	<table border="1"> <thead> <tr> <th>Kind</th> <th>Value</th> </tr> </thead> <tbody> <tr> <td>pattern</td> <td>((([0-9]{1,12}[0-9]{3,01})(0[13578][10]12\d{4})) ([0]{1,9}[12][0-9]{30}(0[469][11]\d{4})) ([0]{1,9}[1][0-9]{2[0-8]}(02\d{4})) ((29)(02)[02468][048]00)) ((29)(02)[13579][26]00)) ((29)(02)[0-9][0-9][0][48])) ((29)(02)[0-9][0-9][2468][048])) ((29)(02)[0-9][0-9][13579][26]))</td> </tr> </tbody> </table>	Kind	Value	pattern	((([0-9]{1,12}[0-9]{3,01})(0[13578][10]12\d{4})) ([0]{1,9}[12][0-9]{30}(0[469][11]\d{4})) ([0]{1,9}[1][0-9]{2[0-8]}(02\d{4})) ((29)(02)[02468][048]00)) ((29)(02)[13579][26]00)) ((29)(02)[0-9][0-9][0][48])) ((29)(02)[0-9][0-9][2468][048])) ((29)(02)[0-9][0-9][13579][26]))
Kind	Value				
pattern	((([0-9]{1,12}[0-9]{3,01})(0[13578][10]12\d{4})) ([0]{1,9}[12][0-9]{30}(0[469][11]\d{4})) ([0]{1,9}[1][0-9]{2[0-8]}(02\d{4})) ((29)(02)[02468][048]00)) ((29)(02)[13579][26]00)) ((29)(02)[0-9][0-9][0][48])) ((29)(02)[0-9][0-9][2468][048])) ((29)(02)[0-9][0-9][13579][26]))				

element **Dati_Sottoscrittore_Type/ProceduraNonTerminata**

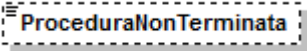
diagram	
namespace	urn:www.agenziaentrate.gov.it:specificheTecniche:sco:common
type	DatoCB_Type
facets	Kind Value pattern [01]

element **Dati_Sottoscrittore_Type/FineProcedura**

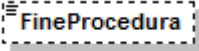
diagram	
namespace	urn:www.agenziaentrate.gov.it:specificheTecniche:sco:common
type	DatoDT_Type
facets	Kind Value pattern (((([0-9][1-9][12][0-9][3][01])([0-9][13578][10][12](\d{4}))))((([0][1-9][12][0-9][30][469][11](\d{4}))))((([0][1-9][1][0-9][2][0-8])([02](\d{4}))))(((29)([02][02468][048]00))(((29)([02][13579][26]00))(((29)([02][0-9][0-9][0][48]))(((29)([02][0-9][2468][048]))(((29)([02][0-9][13579][26]))))

complexType **Domicilio_EE_Type**

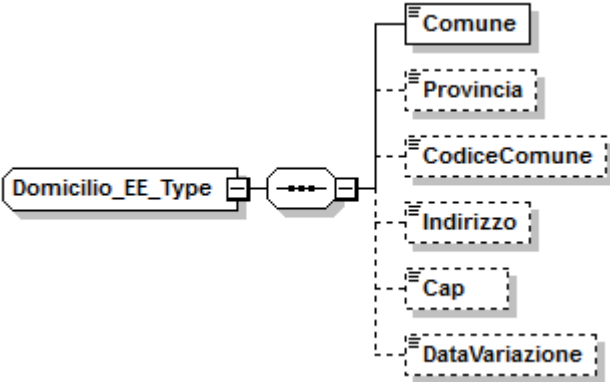
diagram	
namespace	urn:www.agenziaentrate.gov.it:specificheTecniche:sco:common
children	Comune Provincia CodiceComune Indirizzo Cap DataVariazione

element **Domicilio_EE_Type/Comune**

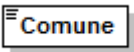
diagram	
namespace	urn:www.agenziaentrate.gov.it:specificheTecniche:sco:common
type	DatoAN_Type
facets	Kind Value pattern ([0-9A-Z\-\-]"}{1}([0-9A-Z& ; ! \- \., / ° ^\\(\)\ À É Ë ì Ò Ù Û " \\ /+)*

element Domicilio_EE_Type/Provincia

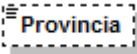
diagram	
namespace	urn:www.agenziaentrate.gov.it:specificheTecniche:sco:common
type	PE_Type

element Domicilio_EE_Type/CodiceComune

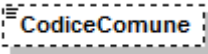
diagram	
namespace	urn:www.agenziaentrate.gov.it:specificheTecniche:sco:common
type	DatoAN_Type
facets	Kind Value pattern ([0-9A-Z-]*)"}{1}([0-9A-Z&#223;] \- \- _ / \^\(\ \) À É Ê Ï Ò Ù Û " \ \\ \+)*

element Domicilio_EE_Type/Indirizzo

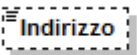
diagram	
namespace	urn:www.agenziaentrate.gov.it:specificheTecniche:sco:common
type	DatoAN_Type
facets	Kind Value pattern ([0-9A-Z-]*)"}{1}([0-9A-Z&#223;] \- \- _ / \^\(\ \) À É Ê Ï Ò Ù Û " \ \\ \+)*

element Domicilio_EE_Type/Cap

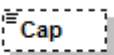
diagram	
namespace	urn:www.agenziaentrate.gov.it:specificheTecniche:sco:common
type	DatoCP_Type
facets	Kind Value pattern [0-9]{5}

element Domicilio_EE_Type/DataVariazione

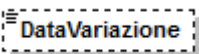
diagram	
namespace	urn:www.agenziaentrate.gov.it:specificheTecniche:sco:common
type	DatoD6_Type
facets	Kind Value pattern ((0[0-9])(1[0-2]))((19 20)[0-9][0-9])

complexType **Domicilio_Fiscale_Type**

diagram	
namespace	urn:www.agenziaentrate.gov.it:specificheTecniche:sco:common
type	extension of Domicilio_Ita_Type
children	Comune Provincia CodiceComune Indirizzo Cap DataVariazione

element **Domicilio_Fiscale_Type/DataVariazione**

diagram					
namespace	urn:www.agenziaentrate.gov.it:specificheTecniche:sco:common				
type	DatoD6_Type				
facets	<table border="0"> <tr> <td>Kind</td> <td>Value</td> </tr> <tr> <td>pattern</td> <td>((0[0-9]) (1[0-2]))((19 20)[0-9][0-9])</td> </tr> </table>	Kind	Value	pattern	((0[0-9]) (1[0-2]))((19 20)[0-9][0-9])
Kind	Value				
pattern	((0[0-9]) (1[0-2]))((19 20)[0-9][0-9])				

complexType **Domicilio_Ita_Type**

diagram	
namespace	urn:www.agenziaentrate.gov.it:specificheTecniche:sco:common
children	Comune Provincia CodiceComune Indirizzo Cap

element Domicilio_Ita_Type/Comune

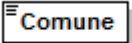
diagram	
namespace	urn:www.agenziaentrate.gov.it:specificheTecniche:sco:common
type	DatoAN_Type
facets	Kind Value pattern ([0-9A-Z\-\"]{1}([0-9A-Z&#39; \-\ \. / \^\(\ \)\À È É Ì Ò Ù Ü " \ \ \ +)*

element Domicilio_Ita_Type/Provincia

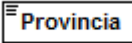
diagram	
namespace	urn:www.agenziaentrate.gov.it:specificheTecniche:sco:common
type	PR_Type

element Domicilio_Ita_Type/CodiceComune

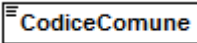
diagram	
namespace	urn:www.agenziaentrate.gov.it:specificheTecniche:sco:common
type	DatoAN_Type
facets	Kind Value pattern ([0-9A-Z\-\"]{1}([0-9A-Z&#39; \-\ \. / \^\(\ \)\À È É Ì Ò Ù Ü " \ \ \ +)*

element Domicilio_Ita_Type/Indirizzo

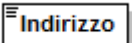
diagram	
namespace	urn:www.agenziaentrate.gov.it:specificheTecniche:sco:common
type	DatoAN_Type
facets	Kind Value pattern ([0-9A-Z\-\"]{1}([0-9A-Z&#39; \-\ \. / \^\(\ \)\À È É Ì Ò Ù Ü " \ \ \ +)*

element Domicilio_Ita_Type/Cap

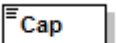
diagram	
namespace	urn:www.agenziaentrate.gov.it:specificheTecniche:sco:common
type	DatoCP_Type
facets	Kind Value pattern [0-9]{5}

complexType Firma_Revisione_Type

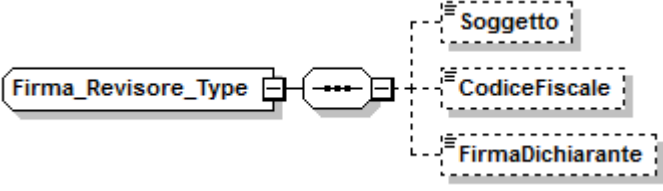
diagram	
namespace	urn:www.agenziaentrate.gov.it:specificheTecniche:sco:common
children	Soggetto CodiceFiscale FirmaDichiarante

element Firma_Revisione_Type/Soggetto

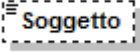
diagram					
namespace	urn:www.agenziaentrate.gov.it:specificheTecniche:sco:common				
type	restriction of DatoNP_Type				
facets	<table border="1"> <tr> <td>Kind</td> <td>Value</td> </tr> <tr> <td>pattern</td> <td>[1-4]</td> </tr> </table>	Kind	Value	pattern	[1-4]
Kind	Value				
pattern	[1-4]				

element Firma_Revisione_Type/CodiceFiscale

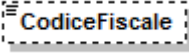
diagram					
namespace	urn:www.agenziaentrate.gov.it:specificheTecniche:sco:common				
type	DatoCF_Type				
facets	<table border="1"> <tr> <td>Kind</td> <td>Value</td> </tr> <tr> <td>pattern</td> <td>[0-9]{11}[A-Z]{6}[0-9LMNPQRSTUVWXYZ]{2}[A-Z]{1}[0-9LMNPQRSTUVWXYZ]{2}[A-Z]{1}[0-9LMNPQRSTUVWXYZ]{3}[A-Z]{1}</td> </tr> </table>	Kind	Value	pattern	[0-9]{11}[A-Z]{6}[0-9LMNPQRSTUVWXYZ]{2}[A-Z]{1}[0-9LMNPQRSTUVWXYZ]{2}[A-Z]{1}[0-9LMNPQRSTUVWXYZ]{3}[A-Z]{1}
Kind	Value				
pattern	[0-9]{11}[A-Z]{6}[0-9LMNPQRSTUVWXYZ]{2}[A-Z]{1}[0-9LMNPQRSTUVWXYZ]{2}[A-Z]{1}[0-9LMNPQRSTUVWXYZ]{3}[A-Z]{1}				

element Firma_Revisione_Type/FirmaDichiarante

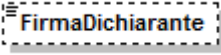
diagram					
namespace	urn:www.agenziaentrate.gov.it:specificheTecniche:sco:common				
type	DatoCB_Type				
facets	<table border="1"> <tr> <td>Kind</td> <td>Value</td> </tr> <tr> <td>pattern</td> <td>[01]</td> </tr> </table>	Kind	Value	pattern	[01]
Kind	Value				
pattern	[01]				

complexType Firma_Type

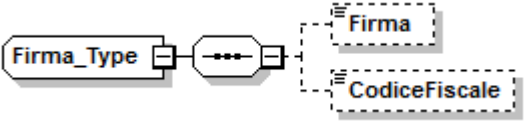
diagram	
namespace	urn:www.agenziaentrate.gov.it:specificheTecniche:sco:common

children	Firma CodiceFiscale
----------	-------------------------------------

element Firma_Type/Firma

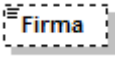
diagram	
namespace	urn:www.agenziaentrate.gov.it:specificheTecniche:sco:common
type	DatoCB Type
facets	Kind Value pattern [01]

element Firma_Type/CodiceFiscale

diagram	
namespace	urn:www.agenziaentrate.gov.it:specificheTecniche:sco:common
type	restriction of xs:string
facets	Kind Value pattern (([0-9A-Z-] \"){0,1}([0-9A-Z&#x26;#x27; \- \., _ s / ^^\(\ \) À È É Ì Ò Ù Û " \N / +)*

complexType Frontespizio_Type

diagram	
namespace	urn:www.agenziaentrate.gov.it:specificheTecniche:sco:common
children	SoggettoFiscale

element Frontespizio_Type/SoggettoFiscale

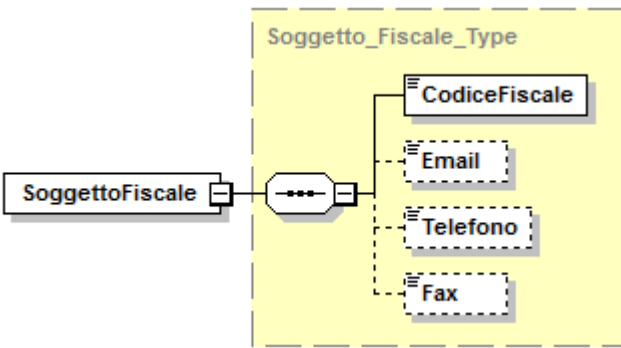
diagram	
namespace	urn:www.agenziaentrate.gov.it:specificheTecniche:sco:common
type	Soggetto Fiscale Type
children	CodiceFiscale Email Telefono Fax

complexType **Impegno_A_Trasmettere_Type**

diagram	
namespace	urn:www.agenziaentrate.gov.it:specificheTecniche:sco:common
children	CFintermediario NumerolscrAlboCAF ImpegnoATrasmettere RicezioneAvvisoTelem DataImpegno FirmaIntermediario

element **Impegno_A_Trasmettere_Type/CFintermediario**

diagram					
namespace	urn:www.agenziaentrate.gov.it:specificheTecniche:sco:common				
type	DatoCF_Type				
facets	<table border="1"> <thead> <tr> <th>Kind</th> <th>Value</th> </tr> </thead> <tbody> <tr> <td>pattern</td> <td>[0-9]{11}[A-Z]{6}[0-9LMNPQRSTUUV]{2}[A-Z]{1}[0-9LMNPQRSTUUV]{2}[A-Z]{1}[0-9LMNPQRSTUUV]{3}[A-Z]{1}</td> </tr> </tbody> </table>	Kind	Value	pattern	[0-9]{11}[A-Z]{6}[0-9LMNPQRSTUUV]{2}[A-Z]{1}[0-9LMNPQRSTUUV]{2}[A-Z]{1}[0-9LMNPQRSTUUV]{3}[A-Z]{1}
Kind	Value				
pattern	[0-9]{11}[A-Z]{6}[0-9LMNPQRSTUUV]{2}[A-Z]{1}[0-9LMNPQRSTUUV]{2}[A-Z]{1}[0-9LMNPQRSTUUV]{3}[A-Z]{1}				

element **Impegno_A_Trasmettere_Type/NumerolscrAlboCAF**

diagram					
namespace	urn:www.agenziaentrate.gov.it:specificheTecniche:sco:common				
type	restriction of DatoNU_Type				
facets	<table border="1"> <thead> <tr> <th>Kind</th> <th>Value</th> </tr> </thead> <tbody> <tr> <td>pattern</td> <td>(\[1-9\]\ [1-9]\)[0-9]*</td> </tr> </tbody> </table>	Kind	Value	pattern	(\[1-9\]\ [1-9]\)[0-9]*
Kind	Value				
pattern	(\[1-9\]\ [1-9]\)[0-9]*				

element **Impegno_A_Trasmettere_Type/ImpegnoATrasmettere**

diagram									
namespace	urn:www.agenziaentrate.gov.it:specificheTecniche:sco:common								
type	restriction of DatoNP_Type								
facets	<table border="1"> <thead> <tr> <th>Kind</th> <th>Value</th> </tr> </thead> <tbody> <tr> <td>pattern</td> <td>1 2</td> </tr> <tr> <td>enumeration</td> <td>1</td> </tr> <tr> <td>enumeration</td> <td>2</td> </tr> </tbody> </table>	Kind	Value	pattern	1 2	enumeration	1	enumeration	2
Kind	Value								
pattern	1 2								
enumeration	1								
enumeration	2								

element **Impegno_A_Trasmettere_Type/RicezioneAvvisoTelem**

diagram	
namespace	urn:www.agenziaentrate.gov.it:specificheTecniche:sco:common
type	DatoCB_Type
facets	Kind Value pattern [01]

element **Impegno_A_Trasmettere_Type/DatalImpegno**

diagram	
namespace	urn:www.agenziaentrate.gov.it:specificheTecniche:sco:common
type	DatoDT_Type
facets	Kind Value pattern (((([0-9][12][0-9][3][01])([0-9][13578][10][12](\d{4}))) ((([0-9][1-9][12][0-9][30)([0-9][469][11](\d{4}))) ((([0-9][1-9][1][0-9][2][0-8])([0-9][2](\d{4}))) ((([29][02][02468][048][00]) ((([29][02][13579][26][00]) ((([29][02][0-9][0-9][0][48]) ((([29][02][0-9][0-9][2468][048]) ((([29][02][0-9][0-9][13579][26]))))))))))))

element **Impegno_A_Trasmettere_Type/FirmaIntermediario**

diagram	
namespace	urn:www.agenziaentrate.gov.it:specificheTecniche:sco:common
type	DatoCB_Type
facets	Kind Value pattern [01]

complexType **Persone_Fisiche_Type**

diagram	
namespace	urn:www.agenziaentrate.gov.it:specificheTecniche:sco:common
children	DatiAnagrafici ResidenzaAnagrafica

element **Persone_Fisiche_Type/DatiAnagrafici**

<p>diagram</p>	
<p>namespace</p>	<p>urn:www.agenziaentrate.gov.it:specificheTecniche:sco:common</p>
<p>type</p>	<p>Dati_Anagrafici_Type</p>
<p>children</p>	<p>Cognome Nome Sesso DataNascita ComuneNascita ProvinciaNascita</p>

element **Persone_Fisiche_Type/ResidenzaAnagrafica**

<p>diagram</p>	
<p>namespace</p>	<p>urn:www.agenziaentrate.gov.it:specificheTecniche:sco:common</p>
<p>type</p>	<p>Residenza_Anagrafica_Type</p>
<p>children</p>	<p>Comune Provincia CodiceComune Indirizzo Cap DataVariazione</p>

complexType **Residenza_Anagrafica_Type**

<p>diagram</p>	
<p>namespace</p>	<p>urn:www.agenziaentrate.gov.it:specificheTecniche:sco:common</p>
<p>type</p>	<p>extension of Domicilio_Ita_Type</p>
<p>children</p>	<p>Comune Provincia CodiceComune Indirizzo Cap DataVariazione</p>

element **Residenza_Anagrafica_Type/DataVariazione**

<p>diagram</p>					
<p>namespace</p>	<p>urn:www.agenziaentrate.gov.it:specificheTecniche:sco:common</p>				
<p>type</p>	<p>DatoDT_Type</p>				
<p>facets</p>	<table border="1"> <thead> <tr> <th>Kind</th> <th>Value</th> </tr> </thead> <tbody> <tr> <td>pattern</td> <td>(((0[1-9] [12][0-9] 301))(0[13578] 10 12)(\d{4})) ((0[1-9] [12][0-9] 30)(0[469] 11)(\d{4})) ((0[1-9] 1[0-9] 2[0-8])(02)(\d{4})) ((29)(02)([02468][048]00)) ((29)(02)([13579][26]00)) ((29)(02)([0-9][0-9][0148])) ((29)(02)([0-9][0-9][2468][048])) ((29)(02)([0-9][0-9][13579][26]))))</td> </tr> </tbody> </table>	Kind	Value	pattern	(((0[1-9] [12][0-9] 301))(0[13578] 10 12)(\d{4})) ((0[1-9] [12][0-9] 30)(0[469] 11)(\d{4})) ((0[1-9] 1[0-9] 2[0-8])(02)(\d{4})) ((29)(02)([02468][048]00)) ((29)(02)([13579][26]00)) ((29)(02)([0-9][0-9][0148])) ((29)(02)([0-9][0-9][2468][048])) ((29)(02)([0-9][0-9][13579][26]))))
Kind	Value				
pattern	(((0[1-9] [12][0-9] 301))(0[13578] 10 12)(\d{4})) ((0[1-9] [12][0-9] 30)(0[469] 11)(\d{4})) ((0[1-9] 1[0-9] 2[0-8])(02)(\d{4})) ((29)(02)([02468][048]00)) ((29)(02)([13579][26]00)) ((29)(02)([0-9][0-9][0148])) ((29)(02)([0-9][0-9][2468][048])) ((29)(02)([0-9][0-9][13579][26]))))				

complexType **Residenza_Estera_Type**

<p>diagram</p>	
<p>namespace</p>	<p>urn:www.agenziaentrate.gov.it:specificheTecniche:sco:common</p>
<p>children</p>	<p>CodiceStatoEstero StatoFederato LocalitaEstero IndirizzoEstero</p>

element **Residenza_Estera_Type/CodiceStatoEstero**

diagram	
namespace	urn:www.agenziaentrate.gov.it:specificheTecniche:sco:common
type	restriction of DatoAN_Type
facets	Kind Value pattern ([0-9A-Z\-\] \"){1}([0-9A-Z&] '\- \., /'°\^\(\)\}À É È Ì Ò Ù Û "; \\ / +)*

element **Residenza_Estera_Type/StatoFederato**

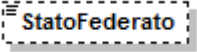
diagram	
namespace	urn:www.agenziaentrate.gov.it:specificheTecniche:sco:common
type	restriction of DatoAN_Type
facets	Kind Value pattern ([0-9A-Z\-\] \"){1}([0-9A-Z&] '\- \., /'°\^\(\)\}À É È Ì Ò Ù Û "; \\ / +)*

element **Residenza_Estera_Type/LocalitaEstero**

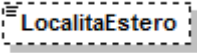
diagram	
namespace	urn:www.agenziaentrate.gov.it:specificheTecniche:sco:common
type	DatoAN_Type
facets	Kind Value pattern ([0-9A-Z\-\] \"){1}([0-9A-Z&] '\- \., /'°\^\(\)\}À É È Ì Ò Ù Û "; \\ / +)*

element **Residenza_Estera_Type/IndirizzoEstero**

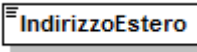
diagram	
namespace	urn:www.agenziaentrate.gov.it:specificheTecniche:sco:common
type	DatoAN_Type
facets	Kind Value pattern ([0-9A-Z\-\] \"){1}([0-9A-Z&] '\- \., /'°\^\(\)\}À É È Ì Ò Ù Û "; \\ / +)*

complexType **Soggetti_Diversi_Da_PF_Type**

<p>diagram</p>	
<p>namespace</p>	<p>urn:www.agenziaentrate.gov.it:specificheTecniche:sco:common</p>
<p>children</p>	<p>Denominazione SedeLegale DomicilioFiscale DataApprovazioneBilancio TermineApprovazioneBilancio InizioPeriodoImposta FinePeriodoImposta Stato NaturaGiuridica Situazione</p>

element **Soggetti_Diversi_Da_PF_Type/Denominazione**

<p>diagram</p>	
<p>namespace</p>	<p>urn:www.agenziaentrate.gov.it:specificheTecniche:sco:common</p>
<p>type</p>	<p>DatoAN_Type</p>
<p>facets</p>	<p>Kind Value pattern <code>(([0-9A-Z-] \&quot;){1}([0-9A-Z&amp;#39; ' \- \. , / \^\(\)\] À É È Ì Ò Ù Û &quot; \ \\ \\+)*</code></p>

element **Soggetti_Diversi_Da_PF_Type/SedeLegale**

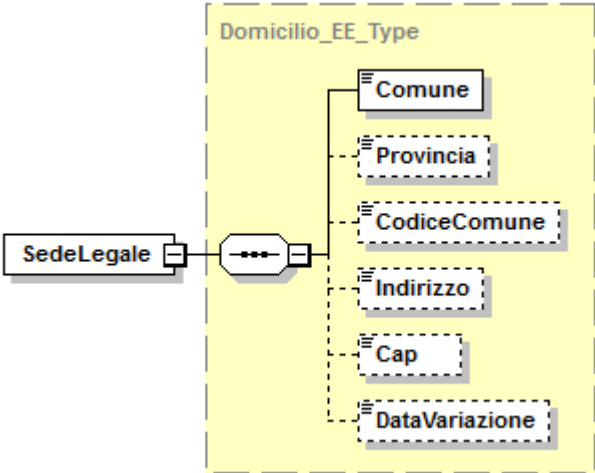
<p>diagram</p>	 <p>The diagram illustrates the structure of the SedeLegale element. It is connected to a container labeled Domicilio_EE_Type. Inside this container, there are six fields: Comune, Provincia, CodiceComune, Indirizzo, Cap, and DataVariazione. The Comune field is shown as a solid box, while the others are dashed boxes. The SedeLegale element is connected to the container via a line with a small square at the end.</p>
<p>namespace</p>	<p>urn:www.agenziaentrate.gov.it:specificheTecniche:sco:common</p>
<p>type</p>	<p>Domicilio_EE_Type</p>
<p>children</p>	<p>Comune Provincia CodiceComune Indirizzo Cap DataVariazione</p>

element **Soggetti_Diversi_Da_PF_Type/DomicilioFiscale**

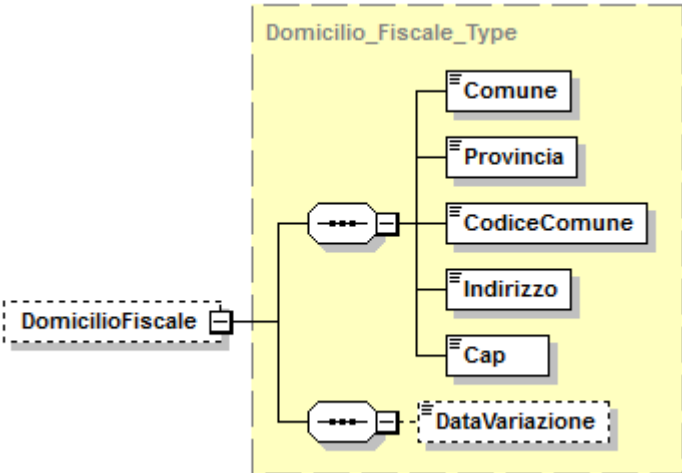
<p>diagram</p>	 <p>The diagram illustrates the structure of the DomicilioFiscale element. It is connected to a container labeled Domicilio_Fiscale_Type. Inside this container, there are six fields: Comune, Provincia, CodiceComune, Indirizzo, Cap, and DataVariazione. The Comune, Provincia, Indirizzo, and Cap fields are shown as solid boxes, while CodiceComune and DataVariazione are dashed boxes. The DomicilioFiscale element is connected to the container via a line with a small square at the end.</p>
<p>namespace</p>	<p>urn:www.agenziaentrate.gov.it:specificheTecniche:sco:common</p>
<p>type</p>	<p>Domicilio_Fiscale_Type</p>
<p>children</p>	<p>Comune Provincia CodiceComune Indirizzo Cap DataVariazione</p>

element **Soggetti_Diversi_Da_PF_Type/DataApprovazioneBilancio**

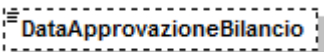
<p>diagram</p>	 <p>The diagram shows a single dashed box representing the DataApprovazioneBilancio element.</p>
<p>namespace</p>	<p>urn:www.agenziaentrate.gov.it:specificheTecniche:sco:common</p>

type	DatoDT_Type				
facets	<table border="1"> <tr> <td>Kind</td> <td>Value</td> </tr> <tr> <td>pattern</td> <td>((([0-9]{12}[0-9]{3}[01])([0-9]{13578}[10]12)\d{4}))((([0-9]{1-9}[12][0-9]{30})([0-9]{469}[11]\d{4}))((([0-9]{1-9}[1-9]{2}[0-8])([0-9]{2}\d{4}))((29)(02)([0-9]{2468}[048]00))((29)(02)([1-9]{13579}[26]00))((29)(02)([0-9]{0-9}[0][48]))((29)(02)([0-9]{2468}[048]))((29)(02)([0-9]{0-9}[13579][26]))))</td> </tr> </table>	Kind	Value	pattern	((([0-9]{12}[0-9]{3}[01])([0-9]{13578}[10]12)\d{4}))((([0-9]{1-9}[12][0-9]{30})([0-9]{469}[11]\d{4}))((([0-9]{1-9}[1-9]{2}[0-8])([0-9]{2}\d{4}))((29)(02)([0-9]{2468}[048]00))((29)(02)([1-9]{13579}[26]00))((29)(02)([0-9]{0-9}[0][48]))((29)(02)([0-9]{2468}[048]))((29)(02)([0-9]{0-9}[13579][26]))))
Kind	Value				
pattern	((([0-9]{12}[0-9]{3}[01])([0-9]{13578}[10]12)\d{4}))((([0-9]{1-9}[12][0-9]{30})([0-9]{469}[11]\d{4}))((([0-9]{1-9}[1-9]{2}[0-8])([0-9]{2}\d{4}))((29)(02)([0-9]{2468}[048]00))((29)(02)([1-9]{13579}[26]00))((29)(02)([0-9]{0-9}[0][48]))((29)(02)([0-9]{2468}[048]))((29)(02)([0-9]{0-9}[13579][26]))))				

element **Soggetti_Diversi_Da_PF_Type/TermineApprovazioneBilancio**

diagram					
namespace	urn:www.agenziaentrate.gov.it:specificheTecniche:sco:common				
type	DatoDT_Type				
facets	<table border="1"> <tr> <td>Kind</td> <td>Value</td> </tr> <tr> <td>pattern</td> <td>((([0-9]{12}[0-9]{3}[01])([0-9]{13578}[10]12)\d{4}))((([0-9]{1-9}[12][0-9]{30})([0-9]{469}[11]\d{4}))((([0-9]{1-9}[1-9]{2}[0-8])([0-9]{2}\d{4}))((29)(02)([0-9]{2468}[048]00))((29)(02)([1-9]{13579}[26]00))((29)(02)([0-9]{0-9}[0][48]))((29)(02)([0-9]{2468}[048]))((29)(02)([0-9]{0-9}[13579][26]))))</td> </tr> </table>	Kind	Value	pattern	((([0-9]{12}[0-9]{3}[01])([0-9]{13578}[10]12)\d{4}))((([0-9]{1-9}[12][0-9]{30})([0-9]{469}[11]\d{4}))((([0-9]{1-9}[1-9]{2}[0-8])([0-9]{2}\d{4}))((29)(02)([0-9]{2468}[048]00))((29)(02)([1-9]{13579}[26]00))((29)(02)([0-9]{0-9}[0][48]))((29)(02)([0-9]{2468}[048]))((29)(02)([0-9]{0-9}[13579][26]))))
Kind	Value				
pattern	((([0-9]{12}[0-9]{3}[01])([0-9]{13578}[10]12)\d{4}))((([0-9]{1-9}[12][0-9]{30})([0-9]{469}[11]\d{4}))((([0-9]{1-9}[1-9]{2}[0-8])([0-9]{2}\d{4}))((29)(02)([0-9]{2468}[048]00))((29)(02)([1-9]{13579}[26]00))((29)(02)([0-9]{0-9}[0][48]))((29)(02)([0-9]{2468}[048]))((29)(02)([0-9]{0-9}[13579][26]))))				

element **Soggetti_Diversi_Da_PF_Type/InizioPeriodoImposta**

diagram					
namespace	urn:www.agenziaentrate.gov.it:specificheTecniche:sco:common				
type	DatoDT_Type				
facets	<table border="1"> <tr> <td>Kind</td> <td>Value</td> </tr> <tr> <td>pattern</td> <td>((([0-9]{12}[0-9]{3}[01])([0-9]{13578}[10]12)\d{4}))((([0-9]{1-9}[12][0-9]{30})([0-9]{469}[11]\d{4}))((([0-9]{1-9}[1-9]{2}[0-8])([0-9]{2}\d{4}))((29)(02)([0-9]{2468}[048]00))((29)(02)([1-9]{13579}[26]00))((29)(02)([0-9]{0-9}[0][48]))((29)(02)([0-9]{2468}[048]))((29)(02)([0-9]{0-9}[13579][26]))))</td> </tr> </table>	Kind	Value	pattern	((([0-9]{12}[0-9]{3}[01])([0-9]{13578}[10]12)\d{4}))((([0-9]{1-9}[12][0-9]{30})([0-9]{469}[11]\d{4}))((([0-9]{1-9}[1-9]{2}[0-8])([0-9]{2}\d{4}))((29)(02)([0-9]{2468}[048]00))((29)(02)([1-9]{13579}[26]00))((29)(02)([0-9]{0-9}[0][48]))((29)(02)([0-9]{2468}[048]))((29)(02)([0-9]{0-9}[13579][26]))))
Kind	Value				
pattern	((([0-9]{12}[0-9]{3}[01])([0-9]{13578}[10]12)\d{4}))((([0-9]{1-9}[12][0-9]{30})([0-9]{469}[11]\d{4}))((([0-9]{1-9}[1-9]{2}[0-8])([0-9]{2}\d{4}))((29)(02)([0-9]{2468}[048]00))((29)(02)([1-9]{13579}[26]00))((29)(02)([0-9]{0-9}[0][48]))((29)(02)([0-9]{2468}[048]))((29)(02)([0-9]{0-9}[13579][26]))))				

element **Soggetti_Diversi_Da_PF_Type/FinePeriodoImposta**

diagram					
namespace	urn:www.agenziaentrate.gov.it:specificheTecniche:sco:common				
type	DatoDT_Type				
facets	<table border="1"> <tr> <td>Kind</td> <td>Value</td> </tr> <tr> <td>pattern</td> <td>((([0-9]{12}[0-9]{3}[01])([0-9]{13578}[10]12)\d{4}))((([0-9]{1-9}[12][0-9]{30})([0-9]{469}[11]\d{4}))((([0-9]{1-9}[1-9]{2}[0-8])([0-9]{2}\d{4}))((29)(02)([0-9]{2468}[048]00))((29)(02)([1-9]{13579}[26]00))((29)(02)([0-9]{0-9}[0][48]))((29)(02)([0-9]{2468}[048]))((29)(02)([0-9]{0-9}[13579][26]))))</td> </tr> </table>	Kind	Value	pattern	((([0-9]{12}[0-9]{3}[01])([0-9]{13578}[10]12)\d{4}))((([0-9]{1-9}[12][0-9]{30})([0-9]{469}[11]\d{4}))((([0-9]{1-9}[1-9]{2}[0-8])([0-9]{2}\d{4}))((29)(02)([0-9]{2468}[048]00))((29)(02)([1-9]{13579}[26]00))((29)(02)([0-9]{0-9}[0][48]))((29)(02)([0-9]{2468}[048]))((29)(02)([0-9]{0-9}[13579][26]))))
Kind	Value				
pattern	((([0-9]{12}[0-9]{3}[01])([0-9]{13578}[10]12)\d{4}))((([0-9]{1-9}[12][0-9]{30})([0-9]{469}[11]\d{4}))((([0-9]{1-9}[1-9]{2}[0-8])([0-9]{2}\d{4}))((29)(02)([0-9]{2468}[048]00))((29)(02)([1-9]{13579}[26]00))((29)(02)([0-9]{0-9}[0][48]))((29)(02)([0-9]{2468}[048]))((29)(02)([0-9]{0-9}[13579][26]))))				

element **Soggetti_Diversi_Da_PF_Type/Stato**

diagram									
namespace	urn:www.agenziaentrate.gov.it:specificheTecniche:sco:common								
type	Stato_Type								
facets	<table border="1"> <tr> <td>Kind</td> <td>Value</td> </tr> <tr> <td>pattern</td> <td>[1-9]{1}[0-9]*</td> </tr> <tr> <td>enumeration</td> <td>1</td> </tr> <tr> <td>enumeration</td> <td>2</td> </tr> </table>	Kind	Value	pattern	[1-9]{1}[0-9]*	enumeration	1	enumeration	2
Kind	Value								
pattern	[1-9]{1}[0-9]*								
enumeration	1								
enumeration	2								

enumeration	3
enumeration	4

element **Soggetti Diversi Da PF_Type/NaturaGiuridica**

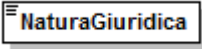
diagram		
namespace	urn:www.agenziaentrate.gov.it:specificheTecniche:sco:common	
type	Natura Giuridica Type	
facets	Kind	Value
	pattern	[1-9]{1}[0-9]*
	enumeration	1
	enumeration	2
	enumeration	3
	enumeration	4
	enumeration	5
	enumeration	6
	enumeration	7
	enumeration	8
	enumeration	9
	enumeration	10
	enumeration	11
	enumeration	12
	enumeration	13
	enumeration	14
	enumeration	15
	enumeration	16
	enumeration	17
	enumeration	18
	enumeration	19
	enumeration	20
	enumeration	21
	enumeration	22
	enumeration	23
	enumeration	24
	enumeration	25
	enumeration	26
	enumeration	27
	enumeration	28
	enumeration	29
	enumeration	30
	enumeration	31
	enumeration	32
	enumeration	33
	enumeration	34
	enumeration	35
	enumeration	36
	enumeration	37
	enumeration	38
	enumeration	39
	enumeration	40
	enumeration	41
	enumeration	42
	enumeration	43
	enumeration	44
	enumeration	45
	enumeration	50
	enumeration	51
	enumeration	52
	enumeration	53
	enumeration	54
	enumeration	55
	enumeration	56
	enumeration	57

enumeration	58
enumeration	59

element **Soggetti Diversi Da PF_Type/Situazione**

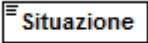
diagram																			
namespace	urn:www.agenziaentrate.gov.it:specificheTecniche:sco:common																		
type	Situazione_Type																		
facets	<table border="1"> <thead> <tr> <th>Kind</th> <th>Value</th> </tr> </thead> <tbody> <tr> <td>pattern</td> <td>[1-9]{1}[0-9]*</td> </tr> <tr> <td>enumeration</td> <td>1</td> </tr> <tr> <td>enumeration</td> <td>2</td> </tr> <tr> <td>enumeration</td> <td>3</td> </tr> <tr> <td>enumeration</td> <td>4</td> </tr> <tr> <td>enumeration</td> <td>5</td> </tr> <tr> <td>enumeration</td> <td>6</td> </tr> <tr> <td>enumeration</td> <td>7</td> </tr> </tbody> </table>	Kind	Value	pattern	[1-9]{1}[0-9]*	enumeration	1	enumeration	2	enumeration	3	enumeration	4	enumeration	5	enumeration	6	enumeration	7
Kind	Value																		
pattern	[1-9]{1}[0-9]*																		
enumeration	1																		
enumeration	2																		
enumeration	3																		
enumeration	4																		
enumeration	5																		
enumeration	6																		
enumeration	7																		

complexType **Soggetti Non Residenti_Type**

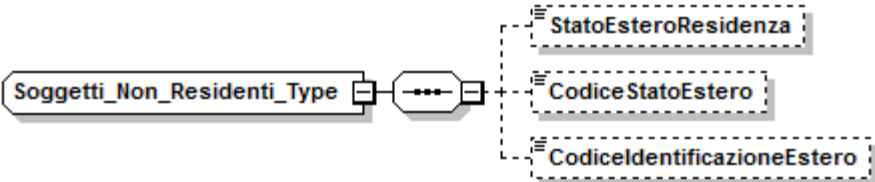
diagram	
namespace	urn:www.agenziaentrate.gov.it:specificheTecniche:sco:common
children	StatoEsteroResidenza CodiceStatoEstero CodiceIdentificazioneEstero

element **Soggetti Non Residenti_Type/StatoEsteroResidenza**

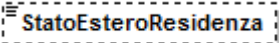
diagram					
namespace	urn:www.agenziaentrate.gov.it:specificheTecniche:sco:common				
type	DatoAN_Type				
facets	<table border="1"> <thead> <tr> <th>Kind</th> <th>Value</th> </tr> </thead> <tbody> <tr> <td>pattern</td> <td>(([0-9A-Z\-\-] &quot;){1}([0-9A-Z&amp;] ' \" \\. / ° \"\\(\) À È É Ì Ò Ù Ú &quot; \\ / +)*</td> </tr> </tbody> </table>	Kind	Value	pattern	(([0-9A-Z\-\-] "){1}([0-9A-Z&] ' \" \\. / ° \"\\(\) À È É Ì Ò Ù Ú " \\ / +)*
Kind	Value				
pattern	(([0-9A-Z\-\-] "){1}([0-9A-Z&] ' \" \\. / ° \"\\(\) À È É Ì Ò Ù Ú " \\ / +)*				

element **Soggetti Non Residenti_Type/CodiceStatoEstero**

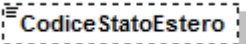
diagram					
namespace	urn:www.agenziaentrate.gov.it:specificheTecniche:sco:common				
type	DatoAN_Type				
facets	<table border="1"> <thead> <tr> <th>Kind</th> <th>Value</th> </tr> </thead> <tbody> <tr> <td>pattern</td> <td>(([0-9A-Z\-\-] &quot;){1}([0-9A-Z&amp;] ' \" \\. / ° \"\\(\) À È É Ì Ò Ù Ú &quot; \\ / +)*</td> </tr> </tbody> </table>	Kind	Value	pattern	(([0-9A-Z\-\-] "){1}([0-9A-Z&] ' \" \\. / ° \"\\(\) À È É Ì Ò Ù Ú " \\ / +)*
Kind	Value				
pattern	(([0-9A-Z\-\-] "){1}([0-9A-Z&] ' \" \\. / ° \"\\(\) À È É Ì Ò Ù Ú " \\ / +)*				

element **Soggetti_Non_Residenti_Type/CodiceIdentificazioneEstero**

diagram	
namespace	urn:www.agenziaentrate.gov.it:specificheTecniche:sco:common
type	DatoAN_Type
facets	Kind Value pattern ([0-9A-Z\-\] \"){1}([0-9A-Z&#39; ! - \., / ° ^\(\ \)\ À É È Ì Ò Ù Û \" \ \\ \ +)*

complexType **Soggetto_Fiscale_Type**

diagram	
namespace	urn:www.agenziaentrate.gov.it:specificheTecniche:sco:common
children	CodiceFiscale Email Telefono Fax

element **Soggetto_Fiscale_Type/CodiceFiscale**

diagram	
namespace	urn:www.agenziaentrate.gov.it:specificheTecniche:sco:common
type	DatoCF_Type
facets	Kind Value pattern [0-9]{11}[A-Z]{6}[0-9LMNPQRSTU]{2}[A-Z]{1}[0-9LMNPQRSTU]{2}[A-Z]{1}[0-9LMNPQRSTU]{3}[A-Z]{1}

element **Soggetto_Fiscale_Type/Email**

diagram	
namespace	urn:www.agenziaentrate.gov.it:specificheTecniche:sco:common
type	DatoEM_Type
facets	Kind Value pattern [a-zA-Z0-9._%'\"?^~=]+@[a-zA-Z0-9.\-]+\.[a-zA-Z]{2,4}

element **Soggetto_Fiscale_Type/Telefono**

diagram	
---------	--

namespace	urn:www.agenziaentrate.gov.it:specificheTecniche:sco:common
type	DatoTL_Type
facets	Kind Value pattern [0-9]*

element **Soggetto_Fiscale_Type/Fax**

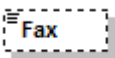
diagram	
namespace	urn:www.agenziaentrate.gov.it:specificheTecniche:sco:common
type	DatoTL_Type
facets	Kind Value pattern [0-9]*

complexType **Tipo_Dichiarazione_Type**

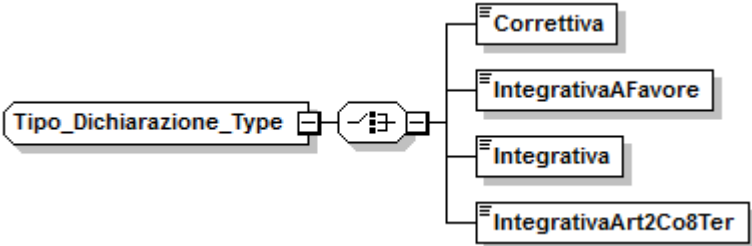
diagram	
namespace	urn:www.agenziaentrate.gov.it:specificheTecniche:sco:common
children	Correttiva IntegrativaAFavore Integrativa IntegrativaArt2Co8Ter

element **Tipo_Dichiarazione_Type/Correttiva**

diagram	
namespace	urn:www.agenziaentrate.gov.it:specificheTecniche:sco:common
type	DatoCB_Type
facets	Kind Value pattern [01]

element **Tipo_Dichiarazione_Type/IntegrativaAFavore**

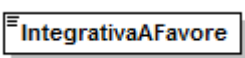
diagram	
namespace	urn:www.agenziaentrate.gov.it:specificheTecniche:sco:common
type	DatoCB_Type
facets	Kind Value pattern [01]

element Tipo_Dichiarazione_Type/Integrativa

diagram	
namespace	urn:www.agenziaentrate.gov.it:specificheTecniche:sco:common
type	DatoCB_Type
facets	Kind Value pattern [01]

element Tipo_Dichiarazione_Type/IntegrativaArt2Co8Ter

diagram	
namespace	urn:www.agenziaentrate.gov.it:specificheTecniche:sco:common
type	DatoCB_Type
facets	Kind Value pattern [01]

complexType Visto_Conformita_Type

diagram	
namespace	urn:www.agenziaentrate.gov.it:specificheTecniche:sco:common
children	VistoCAF CFprofessionista Firma

element Visto_Conformita_Type/VistoCAF

diagram	
namespace	urn:www.agenziaentrate.gov.it:specificheTecniche:sco:common
children	CFResp CF_CAF

element Visto_Conformita_Type/VistoCAF/CFResp

diagram	
namespace	urn:www.agenziaentrate.gov.it:specificheTecniche:sco:common
type	DatoCF_Type

facets	Kind	Value
	pattern	[0-9]{11}[A-Z]{6}[0-9LMNPQRSTUVWXYZ]{2}[A-Z]{1}[0-9LMNPQRSTUVWXYZ]{2}[A-Z]{1}[0-9LMNPQRSTUVWXYZ]{3}[A-Z]{1}

element **Visto_Conformita_Type/VistoCAF/CF_CAF**

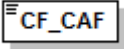
diagram		
namespace	urn:www.agenziaentrate.gov.it:specificheTecniche:sco:common	
type	DatoCN_Type	
facets	Kind	Value
	pattern	[0-9]{11}

element **Visto_Conformita_Type/CFprofessionista**

diagram		
namespace	urn:www.agenziaentrate.gov.it:specificheTecniche:sco:common	
type	DatoCF_Type	
facets	Kind	Value
	pattern	[0-9]{11}[A-Z]{6}[0-9LMNPQRSTUVWXYZ]{2}[A-Z]{1}[0-9LMNPQRSTUVWXYZ]{2}[A-Z]{1}[0-9LMNPQRSTUVWXYZ]{3}[A-Z]{1}

element **Visto_Conformita_Type/Firma**

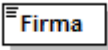
diagram		
namespace	urn:www.agenziaentrate.gov.it:specificheTecniche:sco:common	
type	DatoCB_Type	
facets	Kind	Value
	pattern	[01]

simpleType **Estero**

namespace	urn:www.agenziaentrate.gov.it:specificheTecniche:common	
type	restriction of xs:string	
facets	Kind	Value
	enumeration	EE

simpleType **PE_Type**

namespace	urn:www.agenziaentrate.gov.it:specificheTecniche:common
type	union of (ProvinciItaliane , Estero)

simpleType **PN_Type**

namespace	urn:www.agenziaentrate.gov.it:specificheTecniche:common
-----------	---

type	union of (ProvincieItaliane , ProvincieCroate , Estero , ProvincieSoppresse)
------	--

simpleType PR_Type

namespace	urn:www.agenziaentrate.gov.it:specificheTecniche:common
type	union of (ProvincieItaliane)

simpleType ProvincieCroate

namespace	urn:www.agenziaentrate.gov.it:specificheTecniche:common								
type	restriction of xs:string								
facets	<table border="1"> <thead> <tr> <th>Kind</th> <th>Value</th> </tr> </thead> <tbody> <tr> <td>enumeration</td> <td>FU</td> </tr> <tr> <td>enumeration</td> <td>PL</td> </tr> <tr> <td>enumeration</td> <td>ZA</td> </tr> </tbody> </table>	Kind	Value	enumeration	FU	enumeration	PL	enumeration	ZA
Kind	Value								
enumeration	FU								
enumeration	PL								
enumeration	ZA								

simpleType ProvincieItaliane

namespace	urn:www.agenziaentrate.gov.it:specificheTecniche:common																																																																														
type	restriction of xs:string																																																																														
facets	<table border="1"> <thead> <tr> <th>Kind</th> <th>Value</th> </tr> </thead> <tbody> <tr><td>enumeration</td><td>AG</td></tr> <tr><td>enumeration</td><td>AL</td></tr> <tr><td>enumeration</td><td>AN</td></tr> <tr><td>enumeration</td><td>AO</td></tr> <tr><td>enumeration</td><td>AP</td></tr> <tr><td>enumeration</td><td>AQ</td></tr> <tr><td>enumeration</td><td>AR</td></tr> <tr><td>enumeration</td><td>AT</td></tr> <tr><td>enumeration</td><td>AV</td></tr> <tr><td>enumeration</td><td>BA</td></tr> <tr><td>enumeration</td><td>BG</td></tr> <tr><td>enumeration</td><td>BI</td></tr> <tr><td>enumeration</td><td>BL</td></tr> <tr><td>enumeration</td><td>BN</td></tr> <tr><td>enumeration</td><td>BO</td></tr> <tr><td>enumeration</td><td>BR</td></tr> <tr><td>enumeration</td><td>BS</td></tr> <tr><td>enumeration</td><td>BT</td></tr> <tr><td>enumeration</td><td>BZ</td></tr> <tr><td>enumeration</td><td>CA</td></tr> <tr><td>enumeration</td><td>CB</td></tr> <tr><td>enumeration</td><td>CE</td></tr> <tr><td>enumeration</td><td>CH</td></tr> <tr><td>enumeration</td><td>CI</td></tr> <tr><td>enumeration</td><td>CL</td></tr> <tr><td>enumeration</td><td>CN</td></tr> <tr><td>enumeration</td><td>CO</td></tr> <tr><td>enumeration</td><td>CR</td></tr> <tr><td>enumeration</td><td>CS</td></tr> <tr><td>enumeration</td><td>CT</td></tr> <tr><td>enumeration</td><td>CZ</td></tr> <tr><td>enumeration</td><td>EN</td></tr> <tr><td>enumeration</td><td>FC</td></tr> <tr><td>enumeration</td><td>FE</td></tr> <tr><td>enumeration</td><td>FG</td></tr> <tr><td>enumeration</td><td>FI</td></tr> <tr><td>enumeration</td><td>FM</td></tr> <tr><td>enumeration</td><td>FR</td></tr> </tbody> </table>	Kind	Value	enumeration	AG	enumeration	AL	enumeration	AN	enumeration	AO	enumeration	AP	enumeration	AQ	enumeration	AR	enumeration	AT	enumeration	AV	enumeration	BA	enumeration	BG	enumeration	BI	enumeration	BL	enumeration	BN	enumeration	BO	enumeration	BR	enumeration	BS	enumeration	BT	enumeration	BZ	enumeration	CA	enumeration	CB	enumeration	CE	enumeration	CH	enumeration	CI	enumeration	CL	enumeration	CN	enumeration	CO	enumeration	CR	enumeration	CS	enumeration	CT	enumeration	CZ	enumeration	EN	enumeration	FC	enumeration	FE	enumeration	FG	enumeration	FI	enumeration	FM	enumeration	FR
Kind	Value																																																																														
enumeration	AG																																																																														
enumeration	AL																																																																														
enumeration	AN																																																																														
enumeration	AO																																																																														
enumeration	AP																																																																														
enumeration	AQ																																																																														
enumeration	AR																																																																														
enumeration	AT																																																																														
enumeration	AV																																																																														
enumeration	BA																																																																														
enumeration	BG																																																																														
enumeration	BI																																																																														
enumeration	BL																																																																														
enumeration	BN																																																																														
enumeration	BO																																																																														
enumeration	BR																																																																														
enumeration	BS																																																																														
enumeration	BT																																																																														
enumeration	BZ																																																																														
enumeration	CA																																																																														
enumeration	CB																																																																														
enumeration	CE																																																																														
enumeration	CH																																																																														
enumeration	CI																																																																														
enumeration	CL																																																																														
enumeration	CN																																																																														
enumeration	CO																																																																														
enumeration	CR																																																																														
enumeration	CS																																																																														
enumeration	CT																																																																														
enumeration	CZ																																																																														
enumeration	EN																																																																														
enumeration	FC																																																																														
enumeration	FE																																																																														
enumeration	FG																																																																														
enumeration	FI																																																																														
enumeration	FM																																																																														
enumeration	FR																																																																														

enumeration	GE
enumeration	GO
enumeration	GR
enumeration	IM
enumeration	IS
enumeration	KR
enumeration	LC
enumeration	LE
enumeration	LI
enumeration	LO
enumeration	LT
enumeration	LU
enumeration	MB
enumeration	MC
enumeration	ME
enumeration	MI
enumeration	MN
enumeration	MO
enumeration	MS
enumeration	MT
enumeration	NA
enumeration	NO
enumeration	NU
enumeration	OG
enumeration	OR
enumeration	OT
enumeration	PA
enumeration	PC
enumeration	PD
enumeration	PE
enumeration	PG
enumeration	PI
enumeration	PN
enumeration	PO
enumeration	PR
enumeration	PT
enumeration	PU
enumeration	PV
enumeration	PZ
enumeration	RA
enumeration	RC
enumeration	RE
enumeration	RG
enumeration	RI
enumeration	RM
enumeration	RN
enumeration	RO
enumeration	SA
enumeration	SI
enumeration	SO
enumeration	SP
enumeration	SR
enumeration	SS
enumeration	SV
enumeration	TA
enumeration	TE
enumeration	TN
enumeration	TO
enumeration	TP
enumeration	TR
enumeration	TS
enumeration	TV
enumeration	UD
enumeration	VA
enumeration	VB
enumeration	VC
enumeration	VE
enumeration	VI
enumeration	VR

	enumeration	VS
	enumeration	VT
	enumeration	VV

simpleType ProvincieSoppresse

namespace	urn:www.agenziaentrate.gov.it:specificheTecniche:common	
type	restriction of xs:string	
facets	Kind	Value
	enumeration	FO
	enumeration	PS

simpleType Casella_Quadro_Type

namespace	urn:www.agenziaentrate.gov.it:specificheTecniche:sco:common	
type	restriction of DatoAN_Type	
facets	Kind	Value
	pattern	([0-9A-Z\-\]]"){1}([0-9A-Z&]] ' -\. , /° ^\(\\) À È É ì ò ù Û " \\ \\ +)*
	enumeration	0
	enumeration	1
	enumeration	2
	enumeration	3

simpleType Codice_Carica_Type

namespace	urn:www.agenziaentrate.gov.it:specificheTecniche:sco:common	
type	restriction of DatoNP_Type	
facets	Kind	Value
	pattern	[1-9]{1}[0-9]*
	enumeration	1
	enumeration	2
	enumeration	3
	enumeration	4
	enumeration	5
	enumeration	6
	enumeration	7
	enumeration	8
	enumeration	9
	enumeration	10
	enumeration	11
	enumeration	12
	enumeration	13
	enumeration	14
	enumeration	15

simpleType Codice_Regione_Type

namespace	urn:www.agenziaentrate.gov.it:specificheTecniche:sco:common	
type	restriction of DatoAN_Type	
facets	Kind	Value
	pattern	([0-9A-Z\-\]]"){1}([0-9A-Z&]] ' -\. , /° ^\(\\) À È É ì ò ù Û " \\ \\ +)*
	enumeration	1
	enumeration	2
	enumeration	3
	enumeration	4
	enumeration	5
	enumeration	6

enumeration	7
enumeration	8
enumeration	9
enumeration	10
enumeration	11
enumeration	12
enumeration	13
enumeration	14
enumeration	15
enumeration	16
enumeration	17
enumeration	18
enumeration	19
enumeration	20
enumeration	21

simpleType **Natura_Giuridica_Type**

namespace	urn:www.agenziaentrate.gov.it:specificheTecniche:sco:common	
type	restriction of DatoNP_Type	
facets	Kind	Value
	pattern	[1-9]{1}[0-9]*
	enumeration	1
	enumeration	2
	enumeration	3
	enumeration	4
	enumeration	5
	enumeration	6
	enumeration	7
	enumeration	8
	enumeration	9
	enumeration	10
	enumeration	11
	enumeration	12
	enumeration	13
	enumeration	14
	enumeration	15
	enumeration	16
	enumeration	17
	enumeration	18
	enumeration	19
	enumeration	20
	enumeration	21
	enumeration	22
	enumeration	23
	enumeration	24
	enumeration	25
	enumeration	26
	enumeration	27
	enumeration	28
	enumeration	29
	enumeration	30
	enumeration	31
	enumeration	32
	enumeration	33
	enumeration	34
	enumeration	35
	enumeration	36
	enumeration	37
	enumeration	38
	enumeration	39
	enumeration	40
	enumeration	41
	enumeration	42
	enumeration	43
	enumeration	44

	enumeration	45
	enumeration	50
	enumeration	51
	enumeration	52
	enumeration	53
	enumeration	54
	enumeration	55
	enumeration	56
	enumeration	57
	enumeration	58
	enumeration	59

simpleType Sesso_Type

namespace	urn:www.agenziaentrate.gov.it:specificheTecniche:sco:common	
type	restriction of DatoAN_Type	
facets	Kind	Value
	pattern	(([0-9A-Z-] "){1}([0-9A-Z&] ' \- \., /° °\°\(\) À È É Ì Ò Ù Ü " \ \\ /+)*
	enumeration	M
	enumeration	F

simpleType Situazione_Type

namespace	urn:www.agenziaentrate.gov.it:specificheTecniche:sco:common	
type	restriction of DatoNP_Type	
facets	Kind	Value
	pattern	[1-9]{1}[0-9]*
	enumeration	1
	enumeration	2
	enumeration	3
	enumeration	4
	enumeration	5
	enumeration	6
	enumeration	7

simpleType Stato_Type

namespace	urn:www.agenziaentrate.gov.it:specificheTecniche:sco:common	
type	restriction of DatoNP_Type	
facets	Kind	Value
	pattern	[1-9]{1}[0-9]*
	enumeration	1
	enumeration	2
	enumeration	3
	enumeration	4

simpleType Eventi_Ecc_Type

namespace	urn:www.agenziaentrate.gov.it:specificheTecniche:sco:common	
type	restriction of xs:string	
facets	Kind	Value
	enumeration	1
	enumeration	2
	enumeration	3
	enumeration	4