

ALLEGATO A

-

**Specifiche tecniche per la trasmissione
telematica Modello 730/2012**

INDICE

1	AVVERTENZE GENERALI	3
2	BREVI CENNI SUL LINGUAGGIO XML.....	3
3	CONTENUTO DELLA FORNITURA	4
3.1	GENERALITÀ.....	4
3.2	COERENZA DEI DATI DELLA DICHIARAZIONE	5
3.3	IL TRATTAMENTO DEL CODICE FISCALE	5
3.4	SOGGETTO CHE PRESTA L'ASSISTENZA FISCALE.....	6
4	TRASMISSIONE TELEMATICA DEL MOD. 730-4 DA PARTE DEI CAF, DEL PROFESSIONISTA ABILITATO O DI UNA ASSOCIAZIONE PROFESSIONALE ALL'AGENZIA DELLE ENTRATE E DESTINATO AI SOSTITUTI D'IMPOSTA.....	6
4.1	TRASMISSIONE TELEMATICA DEL MOD. 730-4: CASI PARTICOLARI	6
4.2	DATI MOD. 730-4 RESI DISPONIBILI DALL'AGENZIA DELLE ENTRATE AI SOSTITUTI O INTERMEDIARI.....	7
5	SPECIFICHE TECNICHE IN FORMATO XML.....	7

CONTENUTO E CARATTERISTICHE TECNICHE DEI DATI DELLE DICHIARAZIONI DEI REDDITI MODELLO 730/2012 DA INVIARE ALL'AMMINISTRAZIONE FINANZIARIA IN VIA TELEMATICA

1 AVVERTENZE GENERALI

I Sostituti d'imposta, i Centri di Assistenza Fiscale, i professionisti abilitati, le società e gli enti di grandi dimensioni, nonché gli intermediari abilitati, trasmettono i dati delle dichiarazioni dei Mod.730, all'**Agenzia delle Entrate** in via telematica.

Il contenuto e le caratteristiche della fornitura dei dati da trasmettere sono riportati nelle specifiche tecniche di seguito esposte.

Si precisa che una dichiarazione da inviare, i cui dati non sono conformi alle indicazioni delle presenti specifiche tecniche, verrà scartata.

Le modalità per la trasmissione dei dati in via telematica sono stabilite con il decreto del 31 luglio 1998 (pubblicato nella G.U. del 12 agosto 1998, n. 187) e successive modificazioni.

2 Brevi cenni sul linguaggio XML

L'Agenzia delle Entrate ha scelto di adottare, per la definizione della fornitura relativa alle dichiarazioni 730 2012, il linguaggio XML (eXtensible Markup Language).

L'XML è un metalinguaggio, ossia una "grammatica", per la definizione di documenti da gestire con strumenti informatici.

Per "grammatica" si intende l'insieme standard di definizioni e di regole sintattiche mediante le quali la struttura logica di un documento viene tradotta in una corrispondente struttura fisica, composta di elementi sintattici chiamati **tag**, ossia sequenze di caratteri delimitate dai segni '<' e '>'.

Concretamente, un file XML è un file di testo costituito da diversi **elementi** individuati dai **tag**, ciascuno dei quali identifica un componente logico del documento.

Gli **elementi** sono organizzati secondo una **struttura gerarchica**: ciascun **elemento** può infatti contenere altri elementi (**sottoelementi**) oppure del testo. L'elemento principale della struttura "ad albero" così ottenuta è denominato **radice (root element)**.

Agli **elementi** possono essere associate altre informazioni che ne descrivono le proprietà, tali informazioni sono chiamate **attributi**.

La modellazione della fornitura delle dichiarazioni 730 2012 è stata realizzata definendo una radice denominata proprio **Fornitura**, che rappresenta la fornitura trasmessa telematicamente. All'interno dell'elemento Fornitura sono stati definiti i sottoelementi Intestazione e Documento730.

L'elemento **Intestazione** raccoglie i dati identificativi della fornitura e del soggetto responsabile dell'invio telematico, informazioni che nel tracciato telematico tradizionale erano esposte nel record di tipo A.

L'elemento **Documento730** contiene i seguenti sottoelementi:

- Dichiarazione Dichiarante
- Dichiarazione Coniuge
- Sostituto
- Conguaglio
- Soggetto Assistenza Fiscale
- Documento 730-4
- Altri dati

La struttura della fornitura xml è descritta, mediante l'**XML Schema**, in uno specifico documento (**schema document**), identificato dall'estensione "**xsd**". Il file XSD (XML Schema Definition) delinea il contenuto della fornitura definendone gli elementi ed evidenziandone attributi e relazioni reciproche.

In particolare, lo **schema** relativo alla fornitura xml identifica tre diverse tipologie di componenti: elementi di significato generale, ossia indipendenti dal tipo di documento contenuto nella fornitura stessa, elementi che rappresentano i componenti logici di una generica dichiarazione ed elementi che costituiscono, più specificamente, la struttura di una dichiarazione Modello 730.

Ciascuna delle suddette tipologie di componenti individua un "dominio di nomi" (**namespace**), un ambito nel quale gli elementi sono univoci ed hanno significato omogeneo.

Concretamente, lo schema relativo alla fornitura 730 si compone di un insieme di documenti xsd, associati ai tre diversi namespace, nei quali sono definiti, oltre agli elementi della fornitura, anche i tipi di dati ad essi associati ed alcuni elenchi di codici predefiniti previsti per gli elementi della dichiarazione.

3 CONTENUTO DELLA FORNITURA

3.1 Generalità

La fornitura oggetto della trasmissione telematica deve essere conforme alle specifiche dell'eXtensible Markup Language (XML) 1.0 (raccomandazione WC3 10 febbraio 1998) e deve essere codificata secondo la codifica UTF-8.

Il contenuto della fornitura xml, relativa al Modello 730 2012, deve inoltre soddisfare la sintassi descritta nel file XSD denominato "**fornitura73012_v1.xsd**", allegato al presente documento.

Il suddetto schema definisce la struttura della fornitura xml, delineando gli elementi permessi, i loro attributi, i tipi di dati ad essi associati e la relazione gerarchica tra gli elementi stessi.

La procedura distribuita dall'Agenzia delle Entrate esegue una prima fase di **validazione** della fornitura, ossia di verifica che il file sia conforme allo schema ad esso associato ed una successiva fase di **controllo**, nella quale esamina la correttezza dei dati indicati applicando regole specifiche per ciascun elemento.

L'esito negativo della validazione determina lo scarto dell'intera fornitura.

I diagnostici generati in fase di **controllo** possono avere una diversa gravità a seconda dell'elemento interessato e possono determinare lo scarto della singola dichiarazione o dell'intera fornitura.

3.2 Coerenza dei dati della dichiarazione

Da quest'anno nella “*Circolare per la liquidazione ed il controllo del modello 730 2012*” trovano esposizione anche le regole che definiscono l'accoglimento o meno della dichiarazione 730 2012 da trasmettere in via telematica all'Agenzia delle Entrate. In particolare sono riportati, oltre a tutti i criteri per la puntuale determinazione delle imposte, anche i criteri di accoglimento della dichiarazione. Tali criteri, sono suddivisi in confermabili e bloccanti. La dichiarazione 730 2012 predisposta con le modalità previste nelle presenti specifiche tecniche XML, deve essere conforme ai criteri sopra citati. La non conformità della dichiarazione ai suddetti criteri, determina il non accoglimento della stessa in sede di trasmissione telematica.

3.3 Il trattamento del Codice Fiscale

I codici fiscali riportati nelle dichiarazioni mod. 730/2012 devono essere formalmente corretti. Si precisa che in sede di accoglimento delle dichiarazioni trasmesse in via telematica, costituirà oggetto di scarto della dichiarazione stessa l'indicazione di un **codice fiscale del contribuente** che, anche se formalmente corretto, non risulti registrato presso l'Anagrafe Tributaria.

Nel caso di omocodia del codice fiscale del contribuente risolta dall'Agenzia delle Entrate con l'attribuzione di un nuovo codice fiscale, l'indicazione in dichiarazione del precedente codice fiscale (omocodice) comporta, in sede di accoglimento delle dichiarazioni trasmesse in via telematica, lo scarto della dichiarazione.

Il codice fiscale del rappresentante essere registrato in Anagrafe Tributaria; la non registrazione comporta lo scarto della dichiarazione in fase di accettazione **senza possibilità di conferma della stessa.**

Il codice fiscale del sostituto d'imposta che effettuerà le operazioni di conguaglio deve essere registrato in Anagrafe Tributaria; la non registrazione comporta lo scarto della dichiarazione in fase di accettazione senza possibilità di conferma della stessa.

3.4 Soggetto che presta l'assistenza fiscale

L'indicazione del soggetto che ha prestato l'assistenza fiscale con i relativi dati identificativi e l'indicazione della data di consegna del mod. 730/2012 sono obbligatori. Si rimanda alle istruzioni fornite nella circolare di liquidazione al paragrafo "13.1.2 Dati assistenza fiscale da riportare nel flusso telematico".

4 TRASMISSIONE TELEMATICA DEL MOD. 730-4 DA PARTE DEI CAF, DEL PROFESSIONISTA ABILITATO O DI UNA ASSOCIAZIONE PROFESSIONALE ALL'AGENZIA DELLE ENTRATE E DESTINATO AI SOSTITUTI D'IMPOSTA

Le modifiche normative apportate al D.M. n. 164 del 1999, prevedono che i soggetti che prestano l'assistenza fiscale trasmettano i risultati finali delle dichiarazioni relative al mod. 730 (mod. 730-4) non più direttamente ai sostituti d'imposta ma all'Agenzia delle Entrate la quale provvederà successivamente ad inviarli telematicamente al sostituto d'imposta.

Pertanto, in sede di trasmissione telematica delle dichiarazioni relative al modello 730 2012, qualora l'assistenza fiscale sia prestata da un CAF, da un professionista abilitato o da una associazione i dati relativi al suddetto mod. 730-4 dovranno essere allegati ai dati della dichiarazione mod. 730/2012 da trasmettere in via telematica.

In sede di accoglimento delle dichiarazioni trasmesse in via telematica, costituisce oggetto di controllo sia la presenza dei dati relativi al mod. 730-4 che la coerenza dei dati contenuti nel mod. 730-4 con quelli presenti nel modello 730/2012. Eventuali anomalie riscontrate determinano lo scarto della dichiarazione.

Ai sostituti d'imposta i dati relativi al mod. 730-4 saranno resi disponibili presso la sede telematica comunicata con l'apposito modello di comunicazione trasmesso all'Agenzia delle Entrate; si rimanda alle precisazioni contenute nel successivo paragrafo "Dati mod. 730-4 resi disponibili dall'Agenzia delle Entrate ai Sostituti o Intermediari".

4.1 Trasmissione telematica del mod. 730-4: Casi particolari

Nel caso in cui dalla liquidazione della dichiarazione (mod. 730 ordinario ovvero mod. 730 integrativo), risulti che non ci sia alcun importo da trattenere o da rimborsare a cura del sostituto d'imposta, i dati relativi al mod. 730-4 non devono essere riportati nel tracciato telematico della dichiarazione 730 2012 e deve essere impostato ad "1" l'apposito campo (**FlagAssenzaDati730-4**) previsto nelle presenti specifiche tecniche del modello 730/2012. La non corretta impostazione della suddetta casella determina lo scarto della dichiarazione 730/2012.



4.2 Dati mod. 730-4 resi disponibili dall’Agenzia delle Entrate ai Sostituti o Intermediari

I dati relativi al mod. 730-4 saranno resi disponibili da parte dell’Agenzia delle Entrate ai sostituti d’imposta ovvero agli intermediari da questi incaricati in conformità alle istruzioni contenute nelle presenti specifiche tecniche relative al mod. 730/2012 nella sezione riferita alla “**Fornitura 730-4**”. La sintassi della fornitura relativa ai mod. 730-4 è descritta nel file XSD denominato “**fornitura730-4_12_v1.xsd**” la cui documentazione è allegata al presente documento.

5 Specifiche tecniche in formato XML

Di seguito viene descritto il contenuto informativo dei dati della fornitura da trasmettere in via telematica (**fornitura73012_v1.xsd e fornitura730-4_12_v1.xsd**).

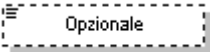
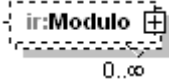
Per la rappresentazione grafica della struttura gerarchica sono utilizzati alcuni simboli grafici descritti nella seguente tabella:

	Elemento obbligatorio
	Elemento opzionale
	Elemento ripetuto 0 o più volte
	Sequenza ordinata di elementi (Sequence)
	Alternativa tra due o più elementi (Choice)

Schema **fornitura73012_v1.xsd**

schema location: [fornitura73012_v1.xsd](#)
attribute form default: **unqualified**
element form default: **qualified**
targetNamespace: **urn:www.agenziaentrate.gov.it:specificheTecniche:sco:730:v1**

Elements	Complex types
Fornitura	Acconti Altri Dati Type
	Acconti Irpef Anno Imposta Type
	Acconti Ritenute Type
	Addizionali Type
	Altre Detrazioni Type
	Altre Ritenute Type
	Altre Spese Type
	Altri Dati Type
	Altri Oneri Type
	Altri Redditi Ass Lavd Type
	Altri Redditi Diversi Detr Type
	Altri Redditi Diversi Type
	Altri Redditi Lavoro Autonomo Type
	Altri Redditi Type
	Altri Redditi Utili Type
	Annotazioni Prospetto Type
	Assegno Coniuge Type
	Casella Acconto Type
	Cedolare Secca Type
	Contributi Previdenza Complementare Type
	Contributo Solidarietà Type
	Cred Imp Estero Type
	Crediti Imposta
	Crediti Imposta Altri Sisma Abruzzo Type
	Crediti Imposta Fabbicati Type
	Crediti Imposta Fondi Pensione Type
	Crediti Imposta Redditi Esteri Type
	Credito Immobiliare Sisma Abruzzo Type
	Credito Stato Type
	Credito Type
	Dati 730Integrativo Type
	Dati Altre Detrazioni Modulo Type
	Dati Altre Detrazioni Type
	Dati Associazioni Professionale Type
	Dati CAF Type
	Dati Catastali Recupero Patrimonio Edilizio Type
	Dati Coniuge Type
	Dati Contabili Type
	Dati Contratto Type

[Dati F24 Imu Type](#)
[Dati Familiare Type](#)
[Dati Nascita PF Type](#)
[Dati Primo Figlio Type](#)
[Dati Professionista Type](#)
[Dati Registrazione Accatastamento Recupero Patrimonio Edilizio Type](#)
[Debito Type](#)
[Deduzioni Modulo Type](#)
[Deduzioni Type](#)
[Detrazione Crediti Type](#)
[Detrazioni Canoni Locazione Type](#)
[Detrazioni Modulo Type](#)
[Detrazioni Type](#)
[Dichiarazione Con Type](#)
[Dichiarazione Dich Type](#)
[Documento 730-4](#)
[Documento 730 Type](#)
[Domicilio Fiscale type](#)
[Domicilio Sogg Ass Fiscale Type](#)
[Eccedenze Type](#)
[Elemento Integrativo Type](#)
[Esenzione Add Comunale Type](#)
[Esito Liquidazione Type](#)
[FabbricatoAgev Type](#)
[FabbricatoOrd Type](#)
[Familiari PrimoModulo Type](#)
[Familiari Type](#)
[Firma Dichiarazione Type](#)
[Fondo Pensione Dipendenti Pubblici Type](#)
[Frontespizio 730 Type](#)
[Frontespizio Con Type](#)
[Frontespizio Dich Type](#)
[Fuori Assistenza Type](#)
[Giorni Percentuale Type](#)
[ICI Type](#)
[Importi Rimborsare730-4 Type](#)
[ImportiTrattenere730-4](#)
[Importo 730-4](#)
[Imposta Lorda Type](#)
[Imposta Netta Type](#)
[Imposte Rimborstate Type](#)
[Incremento Produttività Type](#)
[Inquilini Abitazione Principale Type](#)
[Intervento Recupero Patrimonio Edilizio Type](#)
[Intervento Risparmio Energetico Type](#)
[Intestazione 730 Type](#)
[Lavoro Dipendente Type](#)

[Misura Acconti Type](#)
[Modulo Altri Redditi Type](#)
[Modulo Crediti Imposta Type](#)
[Modulo Fabbricato Type](#)
[Modulo Familiari Type](#)
[Modulo Lavoro Dip Type](#)
[Modulo Oneri Type](#)
[Modulo PL Type](#)
[Modulo Terreno Type](#)
[N Rate Type](#)
[Oneri Type](#)
[Opzione Produttivita Type](#)
[Periodo Di Lavoro Type](#)
[Primo Modulo Acconti Ritenute Type](#)
[Primo Modulo Crediti Imposta Type](#)
[Primo Modulo Lavoro Dip Type](#)
[Primo Modulo PL Type](#)
[PrimoModulo Oneri Type](#)
[Prospetto Liquidazione Type](#)
[Redditi Capitale Type](#)
[Redditi Eredi Legatari Type](#)
[Redditi Fabbricati Type](#)
[Redditi Lavoro Dip Type](#)
[Redditi Ritenute Spese Type](#)
[Redditi Ritenute Type](#)
[Redditi Tassazione Separata Type](#)
[Redditi Terreni Type](#)
[Reddito Erede Type](#)
[Residenza Anagrafica 730 Type](#)
[Residenza Rappresentante Type](#)
[Residenza Type](#)
[Residuo Credito Compens AnnoImposta Type](#)
[Residuo Credito Compens Type](#)
[Riepilogo Redditi Type](#)
[Ritenute Acconti Sospesi Type](#)
[Ritenute Lavoro Dip Type](#)
[Scelte Type](#)
[Sezione Altri Redd Type](#)
[Sezione Dati Catastali Recupero Patrimonio Edilizio Type](#)
[Soggetto Assistenza FiscaliDoc type](#)
[Soggetto Fiscale 730 Type](#)
[Soglie Esenzione Type](#)
[Sostituto Type](#)
[Spese Rateizzate Anni Precedenti Type](#)
[Spese Rateizzate Type](#)
[Tassazione Separata Type](#)
[Terreno Type](#)

schema location: [types730_v1.xsd](#)
attribute form default: **unqualified**
element form default: **qualified**
targetNamespace: **urn:www.agenziaentrate.gov.it:specificheTecniche:sco:730:v1**

Simple types

[Anno Anticipazione Fondo Pensione Type](#)
[Anno Patrimonio Edilizio Situazioni Particolari Type](#)
[Anno Recupero Patrimonio Edilizio Type](#)
[Anno Risparmio Energetico Type](#)
[Casella Codice Type](#)
[Casella Istruzioni Type](#)
[Casi Particolari Risp Ener Type](#)
[CasiParticolariFabbricato Type](#)
[CasiParticolariTerreni Type](#)
[Codice Altre Detrazioni Type](#)
[Codice Altre Spese Type](#)
[Codice Altri Oneri Type](#)
[Codice Evento Eccezionale Type](#)
[Codice Spese Rateizzate Anni Precedenti Type](#)
[Codice Spese Rateizzate Type](#)
[CodiceCanone Type](#)
[FabbricatoAgev Numero Rigo Type](#)
[Indeterminato Determinato Type](#)
[Integrativo Type](#)
[Intero Porzione Type](#)
[Mesi Type](#)
[Numero Rata Risparmi Energetico Type](#)
[Numero Rate5o10 Type](#)
[Numero RateDa1A2 Type](#)
[Numero RateDa1A3 Type](#)
[Numero RateDa2A5 Type](#)
[Periodo 2006 Type](#)
[Rate10 Type](#)
[Rate3 Type](#)
[Rate5 Type](#)
[Rate Risparmio Energetico Type](#)
[Reintegro Totale Parziale Type](#)
[Rideterminazione Rate Type](#)
[Ripart Risparmio Energetico Type](#)
[Serie Registrazione Contratto Type](#)
[Stato Civile Coniuge Type](#)
[Stato Civile Type](#)
[Terreni Urbano Type](#)
[Tipo Fornitore 730 Type](#)
[Tipo Inquilino Type](#)
[Tipo Intervento Type](#)
[Tipo Reddito Da1a12 Type](#)
[Tipo Reddito Da1a3 Type](#)
[Tipo Reddito Da1a6 Type](#)
[Tipo Reddito Da1a7 Type](#)
[Tipo Reddito Da1a8 Type](#)
[Tipologia Soggetto AssFisc Type](#)
[TitoloTerreno Type](#)
[Utilizzo Fabbricato Type](#)

schema location: [fornitura_v2.xsd](#)
attribute form default: **unqualified**
element form default: **qualified**
targetNamespace: **urn:www.agenziaentrate.gov.it:specificheTecniche:common:v2**

Elements	Complex types	Simple types
Documento Fornitura	Dati Intestazione Type Documento Type Intestazione Type	CodiceFornitura Type Identificativo Type

schema location: [datiFiscali_v2.xsd](#)
attribute form default: **unqualified**
element form default: **qualified**
targetNamespace: **urn:www.agenziaentrate.gov.it:specificheTecniche:sco:common:v2**

Complex types

- [Dati Anagrafici Type](#)
- [Dati Sottoscrittore Type](#)
- [Domicilio EE Type](#)
- [Domicilio Fiscale Type](#)
- [Domicilio Ita Type](#)
- [Firma Revisore Type](#)
- [Firma Type](#)
- [Frontespizio Type](#)
- [Impegno A Trasmettere Type](#)
- [Persone Fisiche Type](#)
- [Residenza Anagrafica Type](#)
- [Residenza Estera Type](#)
- [Soggetti Diversi Da PF Type](#)
- [Soggetti Non Residenti Type](#)
- [Soggetto Fiscale Type](#)
- [Tipo Dichiarazione Type](#)
- [Visto Conformita Type](#)

schema location: [fornituraSCE12_v1.xsd](#)
attribute form default: **unqualified**
element form default: **qualified**
targetNamespace: **urn:www.agenziaentrate.gov.it:specificheTecniche:sco:sce:v1**

Elements	Complex types
Fornitura	DatiAnagraficiScelte Type Dichiarazione SCE Type Documento SCE Type Frontespizio SCE Type Intestazione SCE Type Scelta5PerMille Type Scelta8PerMille Type

schema location: [typesDati_v2.xsd](#)
attribute form default: **unqualified**
element form default: **qualified**
targetNamespace: **urn:www.agenziaentrate.gov.it:specificheTecniche:common:v2**

Simple types

[DatoAN_Type](#)
[DatoCB12_Type](#)
[DatoCB_Type](#)
[DatoCF_Type](#)
[DatoCN_Type](#)
[DatoCP_Type](#)
[DatoD6_Type](#)
[DatoDA_Type](#)
[DatoDN_Type](#)
[DatoDT_Type](#)
[DatoEM_Type](#)
[DatoGA_Type](#)
[DatoN1_Type](#)
[DatoNP_Type](#)
[DatoNU_Type](#)
[DatoPC_Type](#)
[DatoPI_Type](#)
[DatoQU_Type](#)
[DatoTL_Type](#)

schema location: [typesFiscali v2.xsd](#)
attribute form default: **unqualified**
element form default: **qualified**
targetNamespace: **urn:www.agenziaentrate.gov.it:specificheTecniche:sco:common:v2**

Simple types

[Casella_Quadro_Type](#)
[Codice_Carica_Type](#)
[Codice_Regione_Type](#)
[Natura_Giuridica_Type](#)
[Sesso_Type](#)
[Situazione_Type](#)
[Stato_Type](#)

schema location: [typeEventi v2.xsd](#)
attribute form default: **unqualified**
element form default: **qualified**
targetNamespace: **urn:www.agenziaentrate.gov.it:specificheTecniche:sco:common:v2**

Simple types

[Eventi_Ecc_Type](#)

schema location: [typesProvince v2.xsd](#)
attribute form default: **unqualified**
element form default: **qualified**
targetNamespace: **urn:www.agenziaentrate.gov.it:specificheTecniche:common:v2**

Simple types

[Esterio](#)
[PE_Type](#)
[PN_Type](#)

element **Fornitura**

diagram	
namespace	urn:www.agenziaentrate.gov.it:specificheTecniche:sco:730:v1
properties	content complex
children	m730:Intestazione m730:Documento730
source	<pre><xs:element name="Fornitura"> <xs:complexType> <xs:sequence> <xs:element name="Intestazione" type="m730:Intestazione_730_Type"/> <xs:element name="Documento730" type="m730:Documento_730_Type" maxOccurs="unbounded"/> </xs:sequence> </xs:complexType> </xs:element></pre>

element **Fornitura/Intestazione**

diagram	
namespace	urn:www.agenziaentrate.gov.it:specificheTecniche:sco:730:v1
type	m730:Intestazione_730_Type
properties	isRef 0 content complex

children	CodiceFiscaleFornitore SpazioUtente SpazioServizioTelematico m730:CodiceFornitura m730:TipoFornitore m730:UfficioPerifericoCaf
source	<code><xs:element name="Intestazione" type="m730:Intestazione_730_Type"/></code>

element **Fornitura/Documento730**

diagram													
namespace	urn:www.agenziaentrate.gov.it:specificheTecniche:sco:730:v1												
type	m730:Documento 730 Type												
properties	isRef 0 minOcc 1 maxOcc unbounded content complex												
children	m730:DichiarazioneDich m730:DichiarazioneCon m730:AltriDati m730:Sostituto m730:Conguaglio m730:SoggettoAssFiscaleDoc m730:Documento_730-4												
attributes	<table border="1"> <thead> <tr> <th>Name</th> <th>Type</th> <th>Use</th> <th>Default</th> <th>Fixed</th> <th>annotation</th> </tr> </thead> <tbody> <tr> <td>identificativo</td> <td>Identificativo_Type</td> <td>required</td> <td></td> <td></td> <td></td> </tr> </tbody> </table>	Name	Type	Use	Default	Fixed	annotation	identificativo	Identificativo_Type	required			
Name	Type	Use	Default	Fixed	annotation								
identificativo	Identificativo_Type	required											
source	<code><xs:element name="Documento730" type="m730:Documento_730_Type" maxOccurs="unbounded"/></code>												

complexType **Acconti_Altri_Dati_Type**

diagram	
namespace	urn:www.agenziaentrate.gov.it:specificheTecniche:sco:730:v1
children	m730:IncapientiDetrazioneFigli m730:IncapientiDetrazioneLocazione m730:RestituzioneBonusFiscale m730:RestituzioneBonusStraordinario m730:Pignoramento
used by	element Primo Modulo Acconti Ritenute Type/AccontiAltriDati
source	<pre> <xs:complexType name="Acconti_Altri_Dati_Type"> <xs:sequence> <xs:element name="IncapientiDetrazioneFigli" type="cm:DatoNP_Type" minOccurs="0"/> <xs:element name="IncapientiDetrazioneLocazione" type="cm:DatoNP_Type" minOccurs="0"/> <xs:element name="RestituzioneBonusFiscale" type="cm:DatoNP_Type" minOccurs="0"/> <xs:element name="RestituzioneBonusStraordinario" type="cm:DatoNP_Type" minOccurs="0"/> <xs:element name="Pignoramento" minOccurs="0"> <xs:complexType> <xs:sequence> <xs:element name="TipoRedditoPignoramento"> <xs:simpleType> <xs:restriction base="cm:DatoN1_Type"> <xs:enumeration value="1"/> <xs:enumeration value="2"/> <xs:enumeration value="3"/> <xs:enumeration value="4"/> <xs:enumeration value="5"/> <xs:enumeration value="6"/> </xs:restriction> </xs:simpleType> </xs:element> <xs:element name="RitenutePignoramento"/> </xs:sequence> </xs:complexType> </xs:element> </xs:sequence> </xs:complexType> </pre>

element **Acconti_Altri_Dati_Type/IncapientiDetrazioneFigli**

diagram	
namespace	urn:www.agenziaentrate.gov.it:specificheTecniche:sco:730:v1
type	DatoNP_Type
properties	isRef 0 minOcc 0 maxOcc 1 content simple
facets	Kind Value annotation pattern [1-9]{1}[0-9]*
source	<pre><xs:element name="IncapientiDetrazioneFigli" type="cm:DatoNP_Type" minOccurs="0"/></pre>

element **Acconti_Altri_Dati_Type/IncapientiDetrazioneLocazione**

diagram	
namespace	urn:www.agenziaentrate.gov.it:specificheTecniche:sco:730:v1
type	DatoNP_Type
properties	isRef 0 minOcc 0 maxOcc 1 content simple
facets	Kind Value annotation pattern [1-9]{1}[0-9]*
source	<pre><xs:element name="IncapientiDetrazioneLocazione" type="cm:DatoNP_Type" minOccurs="0"/></pre>

element **Acconti_Altri_Dati_Type/RestituzioneBonusFiscale**

diagram	
namespace	urn:www.agenziaentrate.gov.it:specificheTecniche:sco:730:v1
type	DatoNP_Type
properties	isRef 0 minOcc 0 maxOcc 1 content simple
facets	Kind Value annotation pattern [1-9]{1}[0-9]*
source	<pre><xs:element name="RestituzioneBonusFiscale" type="cm:DatoNP_Type" minOccurs="0"/></pre>

element **Acconti_Altri_Dati_Type/RestituzioneBonusStraordinario**

diagram	
namespace	urn:www.agenziaentrate.gov.it:specificheTecniche:sco:730:v1
type	DatoNP_Type
properties	isRef 0 minOcc 0 maxOcc 1 content simple
facets	Kind Value annotation pattern [1-9]{1}[0-9]*
source	<pre><xs:element name="RestituzioneBonusStraordinario" type="cm:DatoNP_Type" minOccurs="0"/></pre>

element **Acconti_Altri_Dati_Type/Pignoramento**

diagram	
namespace	urn:www.agenziaentrate.gov.it:specificheTecniche:sco:730:v1
properties	isRef 0 minOcc 0 maxOcc 1 content complex
children	m730:TipoRedditoPignoramento m730:RitenutePignoramento
source	<pre><xs:element name="Pignoramento" minOccurs="0"> <xs:complexType> <xs:sequence> <xs:element name="TipoRedditoPignoramento"> <xs:simpleType> <xs:restriction base="cm:DatoN1_Type"> <xs:enumeration value="1"/> <xs:enumeration value="2"/> <xs:enumeration value="3"/> <xs:enumeration value="4"/> <xs:enumeration value="5"/> <xs:enumeration value="6"/> </xs:restriction> </xs:simpleType> </xs:element> <xs:element name="RitenutePignoramento"/> </xs:sequence> </xs:complexType> </xs:element></pre>

element **Acconti_Altri_Dati_Type/Pignoramento/TipoRedditoPignoramento**

diagram																												
namespace	urn:www.agenziaentrate.gov.it:specificheTecniche:sco:730:v1																											
type	restriction of DatoN1_Type																											
properties	isRef 0 content simple																											
facets	<table border="1"> <thead> <tr> <th>Kind</th> <th>Value</th> <th>annotation</th> </tr> </thead> <tbody> <tr> <td>maxLength</td> <td>1</td> <td></td> </tr> <tr> <td>pattern</td> <td>[1-9]</td> <td></td> </tr> <tr> <td>enumeration</td> <td>1</td> <td></td> </tr> <tr> <td>enumeration</td> <td>2</td> <td></td> </tr> <tr> <td>enumeration</td> <td>3</td> <td></td> </tr> <tr> <td>enumeration</td> <td>4</td> <td></td> </tr> <tr> <td>enumeration</td> <td>5</td> <td></td> </tr> <tr> <td>enumeration</td> <td>6</td> <td></td> </tr> </tbody> </table>	Kind	Value	annotation	maxLength	1		pattern	[1-9]		enumeration	1		enumeration	2		enumeration	3		enumeration	4		enumeration	5		enumeration	6	
Kind	Value	annotation																										
maxLength	1																											
pattern	[1-9]																											
enumeration	1																											
enumeration	2																											
enumeration	3																											
enumeration	4																											
enumeration	5																											
enumeration	6																											
source	<pre> <xs:element name="TipoRedditoPignoramento"> <xs:simpleType> <xs:restriction base="cm:DatoN1_Type"> <xs:enumeration value="1"/> <xs:enumeration value="2"/> <xs:enumeration value="3"/> <xs:enumeration value="4"/> <xs:enumeration value="5"/> <xs:enumeration value="6"/> </xs:restriction> </xs:simpleType> </xs:element> </pre>																											

element **Acconti_Altri_Dati_Type/Pignoramento/RitenutePignoramento**

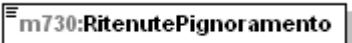
diagram	
namespace	urn:www.agenziaentrate.gov.it:specificheTecniche:sco:730:v1
properties	isRef 0
source	<pre> <xs:element name="RitenutePignoramento"/> </pre>

complexType **Acconti_Irpef_Anno_Imposta_Type**

<p>diagram</p>	
<p>namespace</p>	<p>urn:www.agenziaentrate.gov.it:specificheTecniche:sco:730:v1</p>
<p>children</p>	<p>m730:PrimaRataAccontoIrpef m730:SecondaRataAccontoIrpef m730:EccedenzaAccontoIrpef m730:AccontoAddComunale m730:AccontoAddComunaleF24 m730:PrimaRataAccontoCedolare m730:SecondaRataAccontoCedolare m730:EccedenzaAccontoCedolare</p>
<p>used by</p>	<p>element Primo Modulo Acconti Ritenute Type/Accontilrpef</p>
<p>source</p>	<pre><xs:complexType name="Acconti_Irpef_Anno_Imposta_Type"> <xs:sequence> <xs:element name="PrimaRataAccontoIrpef" type="cm:DatoNP_Type" minOccurs="0"/> <xs:element name="SecondaRataAccontoIrpef" type="cm:DatoNP_Type" minOccurs="0"/> <xs:element name="EccedenzaAccontoIrpef" type="cm:DatoNP_Type" minOccurs="0"/> <xs:element name="AccontoAddComunale" type="cm:DatoNP_Type" minOccurs="0"/> <xs:element name="AccontoAddComunaleF24" type="cm:DatoNP_Type" minOccurs="0"/> <xs:element name="PrimaRataAccontoCedolare" type="cm:DatoNP_Type" minOccurs="0"/> <xs:element name="SecondaRataAccontoCedolare" type="cm:DatoNP_Type" minOccurs="0"/> <xs:element name="EccedenzaAccontoCedolare" type="cm:DatoNP_Type" minOccurs="0"/> </xs:sequence> </xs:complexType></pre>

element **Acconti_Irpef_Anno_Imposta_Type/PrimaRataAccontoIrpef**

<p>diagram</p>	
----------------	--

namespace	urn:www.agenziaentrate.gov.it:specificheTecniche:sco:730:v1
type	DatoNP_Type
properties	isRef 0 minOcc 0 maxOcc 1 content simple
facets	Kind Value annotation pattern [1-9]{1}[0-9]*
source	<pre><xs:element name="PrimaRataAccontoIrpef" type="cm:DatoNP_Type" minOccurs="0"/></pre>

element **Acconti_Irpef_Anno_Imposta_Type/SecondaRataAccontoIrpef**

diagram	
namespace	urn:www.agenziaentrate.gov.it:specificheTecniche:sco:730:v1
type	DatoNP_Type
properties	isRef 0 minOcc 0 maxOcc 1 content simple
facets	Kind Value annotation pattern [1-9]{1}[0-9]*
source	<pre><xs:element name="SecondaRataAccontoIrpef" type="cm:DatoNP_Type" minOccurs="0"/></pre>

element **Acconti_Irpef_Anno_Imposta_Type/EccedenzaAccontoIrpef**

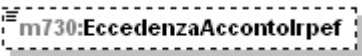
diagram	
namespace	urn:www.agenziaentrate.gov.it:specificheTecniche:sco:730:v1
type	DatoNP_Type
properties	isRef 0 minOcc 0 maxOcc 1 content simple
facets	Kind Value annotation pattern [1-9]{1}[0-9]*
source	<pre><xs:element name="EccedenzaAccontoIrpef" type="cm:DatoNP_Type" minOccurs="0"/></pre>

element **Acconti_Irpef_Anno_Imposta_Type/AccontoAddComunale**

diagram	
namespace	urn:www.agenziaentrate.gov.it:specificheTecniche:sco:730:v1
type	DatoNP_Type

properties	isRef 0 minOcc 0 maxOcc 1 content simple
facets	Kind Value annotation pattern [1-9]{1}[0-9]*
source	<code><xs:element name="AccontoAddComunale" type="cm:DatoNP_Type" minOccurs="0"/></code>

element **Acconti_Irpef_Anno_Imposta_Type/AccontoAddComunaleF24**

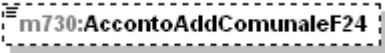
diagram	
namespace	urn:www.agenziaentrate.gov.it:specificheTecniche:sco:730:v1
type	DatoNP_Type
properties	isRef 0 minOcc 0 maxOcc 1 content simple
facets	Kind Value annotation pattern [1-9]{1}[0-9]*
source	<code><xs:element name="AccontoAddComunaleF24" type="cm:DatoNP_Type" minOccurs="0"/></code>

element **Acconti_Irpef_Anno_Imposta_Type/PrimaRataAccontoCedolare**

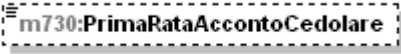
diagram	
namespace	urn:www.agenziaentrate.gov.it:specificheTecniche:sco:730:v1
type	DatoNP_Type
properties	isRef 0 minOcc 0 maxOcc 1 content simple
facets	Kind Value annotation pattern [1-9]{1}[0-9]*
source	<code><xs:element name="PrimaRataAccontoCedolare" type="cm:DatoNP_Type" minOccurs="0"/></code>

element **Acconti_Irpef_Anno_Imposta_Type/SecondaRataAccontoCedolare**

diagram	
namespace	urn:www.agenziaentrate.gov.it:specificheTecniche:sco:730:v1
type	DatoNP_Type
properties	isRef 0 minOcc 0 maxOcc 1

	content simple
facets	Kind Value annotation pattern [1-9]{1}[0-9]*
source	<code><xs:element name="SecondaRataAccontoCedolare" type="cm:DatoNP_Type" minOccurs="0"/></code>

element **Acconti_Irpef_Anno_Imposta_Type/EccedenzaAccontoCedolare**

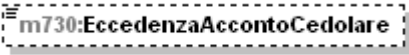
diagram	
namespace	urn:www.agenziaentrate.gov.it:specificheTecniche:sco:730:v1
type	DatoNP_Type
properties	isRef 0 minOcc 0 maxOcc 1 content simple
facets	Kind Value annotation pattern [1-9]{1}[0-9]*
source	<code><xs:element name="EccedenzaAccontoCedolare" type="cm:DatoNP_Type" minOccurs="0"/></code>

complexType **Acconti_Ritenute_Type**

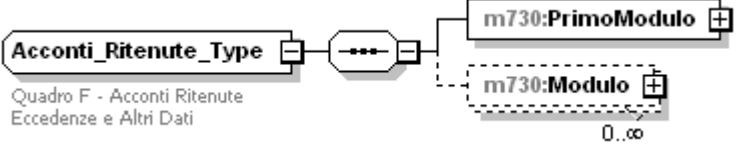
diagram	
namespace	urn:www.agenziaentrate.gov.it:specificheTecniche:sco:730:v1
children	m730:PrimoModulo m730:Modulo
used by	element Dati_Contabili_Type/QuadroF
annotation	documentation Quadro F - Acconti Ritenute Eccedenze e Altri Dati
source	<pre><xs:complexType name="Acconti_Ritenute_Type"> <xs:annotation> <xs:documentation>Quadro F - Acconti Ritenute Eccedenze e Altri Dati</xs:documentation> </xs:annotation> <xs:sequence> <xs:element name="PrimoModulo" type="m730:Primo_Modulo_Acconti_Ritenute_Type"/> <xs:element name="Modulo" minOccurs="0" maxOccurs="unbounded"> <xs:complexType> <xs:sequence> <xs:element name="Pignoramento" minOccurs="0"> <xs:complexType></pre>

```

<xs:sequence>
  <xs:element name="TipoRedditoPignoramento">
    <xs:simpleType>
      <xs:restriction base="cm:DatoN1_Type">
        <xs:enumeration value="1"/>
        <xs:enumeration value="2"/>
        <xs:enumeration value="3"/>
        <xs:enumeration value="4"/>
        <xs:enumeration value="5"/>
        <xs:enumeration value="6"/>
      </xs:restriction>
    </xs:simpleType>
  </xs:element>
  <xs:element name="RitenutePignoramento"/>
</xs:sequence>
</xs:complexType>
</xs:element>
</xs:sequence>
</xs:complexType>
</xs:element>
</xs:sequence>
</xs:complexType>

```

element **Acconti_Ritenute_Type/PrimoModulo**

<p>diagram</p>	
<p>namespace</p>	<p>urn:www.agenziaentrate.gov.it:specificheTecniche:sco:730:v1</p>
<p>type</p>	<p>m730:Primo Modulo Acconti Ritenute Type</p>
<p>properties</p>	<p>isRef 0 content complex</p>

children	m730:Accontilrpef m730:AltreRitenute m730:Eccedenze m730:RitenuteAccontiSospesi m730:MisuraAcconti m730:EsenzioneAddComunale m730:Dati730Integrativo m730:AccontiAltriDati
source	<code><xs:element name="PrimoModulo" type="m730:Primo_Modulo_Acconti_Ritenute_Type"/></code>

element **Acconti_Ritenute_Type/Modulo**

diagram									
namespace	urn:www.agenziaentrate.gov.it:specificheTecniche:sco:730:v1								
properties	<table border="0"> <tr><td>isRef</td><td>0</td></tr> <tr><td>minOcc</td><td>0</td></tr> <tr><td>maxOcc</td><td>unbounded</td></tr> <tr><td>content</td><td>complex</td></tr> </table>	isRef	0	minOcc	0	maxOcc	unbounded	content	complex
isRef	0								
minOcc	0								
maxOcc	unbounded								
content	complex								
children	m730:Pignoramento								
source	<pre> <xs:element name="Modulo" minOccurs="0" maxOccurs="unbounded"> <xs:complexType> <xs:sequence> <xs:element name="Pignoramento" minOccurs="0"> <xs:complexType> <xs:sequence> <xs:element name="TipoRedditoPignoramento"> <xs:simpleType> <xs:restriction base="cm:DatoN1_Type"> <xs:enumeration value="1"/> <xs:enumeration value="2"/> <xs:enumeration value="3"/> <xs:enumeration value="4"/> <xs:enumeration value="5"/> <xs:enumeration value="6"/> </xs:restriction> </xs:simpleType> </xs:element> <xs:element name="RitenutePignoramento"/> </xs:sequence> </xs:complexType> </xs:element> </xs:sequence> </xs:complexType> </xs:element> </pre>								

element **Acconti_Ritenute_Type/Modulo/Pignoramento**

diagram	
namespace	urn:www.agenziaentrate.gov.it:specificheTecniche:sco:730:v1
properties	isRef 0 minOcc 0 maxOcc 1 content complex
children	m730:TipoRedditoPignoramento m730:RitenutePignoramento
source	<pre> <xs:element name="Pignoramento" minOccurs="0"> <xs:complexType> <xs:sequence> <xs:element name="TipoRedditoPignoramento"> <xs:simpleType> <xs:restriction base="cm:DatoN1_Type"> <xs:enumeration value="1"/> <xs:enumeration value="2"/> <xs:enumeration value="3"/> <xs:enumeration value="4"/> <xs:enumeration value="5"/> <xs:enumeration value="6"/> </xs:restriction> </xs:simpleType> </xs:element> <xs:element name="RitenutePignoramento"/> </xs:sequence> </xs:complexType> </xs:element> </pre>

element **Acconti_Ritenute_Type/Modulo/Pignoramento/TipoRedditoPignoramento**

diagram																									
namespace	urn:www.agenziaentrate.gov.it:specificheTecniche:sco:730:v1																								
type	restriction of DatoN1_Type																								
properties	isRef 0 content simple																								
facets	<table border="1"> <thead> <tr> <th>Kind</th> <th>Value</th> <th>annotation</th> </tr> </thead> <tbody> <tr> <td>maxLength</td> <td>1</td> <td></td> </tr> <tr> <td>pattern</td> <td>[1-9]</td> <td></td> </tr> <tr> <td>enumeration</td> <td>1</td> <td></td> </tr> <tr> <td>enumeration</td> <td>2</td> <td></td> </tr> <tr> <td>enumeration</td> <td>3</td> <td></td> </tr> <tr> <td>enumeration</td> <td>4</td> <td></td> </tr> <tr> <td>enumeration</td> <td>5</td> <td></td> </tr> </tbody> </table>	Kind	Value	annotation	maxLength	1		pattern	[1-9]		enumeration	1		enumeration	2		enumeration	3		enumeration	4		enumeration	5	
Kind	Value	annotation																							
maxLength	1																								
pattern	[1-9]																								
enumeration	1																								
enumeration	2																								
enumeration	3																								
enumeration	4																								
enumeration	5																								

	enumeration 6
source	<pre> <xs:element name="TipoRedditoPignoramento"> <xs:simpleType> <xs:restriction base="cm:DatoN1_Type"> <xs:enumeration value="1"/> <xs:enumeration value="2"/> <xs:enumeration value="3"/> <xs:enumeration value="4"/> <xs:enumeration value="5"/> <xs:enumeration value="6"/> </xs:restriction> </xs:simpleType> </xs:element> </pre>

element **Acconti_Ritenute_Type/Modulo/Pignoramento/RitenutePignoramento**

diagram	
namespace	urn:www.agenziaentrate.gov.it:specificheTecniche:sco:730:v1
properties	isRef 0
source	<pre><xs:element name="RitenutePignoramento"/></pre>

complexType **Addizionali_Type**

diagram	
namespace	urn:www.agenziaentrate.gov.it:specificheTecniche:sco:730:v1
children	m730:Imponibile m730:AddRegDovuta m730:AddRegCertif m730:EccedenzaAddReg m730:AddComDovuta m730:AddComCertif m730:EccedenzaAddCom m730:AccontoAddCom2012 m730:AccontoAddCom2012Certif
used by	element Primo Modulo PL Type/Addizionali

source	<pre> <xs:complexType name="Addizionali_Type"> <xs:sequence> <xs:element name="Imponibile" type="cm:DatoNP_Type" minOccurs="0"/> <xs:element name="AddRegDovuta" type="cm:DatoNP_Type" minOccurs="0"/> <xs:element name="AddRegCertif" type="cm:DatoNP_Type" minOccurs="0"/> <xs:element name="EccedenzaAddReg" type="cm:DatoNP_Type" minOccurs="0"/> <xs:element name="AddComDovuta" type="cm:DatoNP_Type" minOccurs="0"/> <xs:element name="AddComCertif" type="cm:DatoNP_Type" minOccurs="0"/> <xs:element name="EccedenzaAddCom" type="cm:DatoNP_Type" minOccurs="0"/> <xs:element name="AccontoAddCom2012" type="cm:DatoNP_Type" minOccurs="0"/> <xs:element name="AccontoAddCom2012Certif" type="cm:DatoNP_Type" minOccurs="0"/> </xs:sequence> </xs:complexType> </pre>
--------	--

element **Addizionali_Type/Imponibile**

diagram									
namespace	urn:www.agenziaentrate.gov.it:specificheTecniche:sco:730:v1								
type	DatoNP_Type								
properties	<table border="0"> <tr><td>isRef</td><td>0</td></tr> <tr><td>minOcc</td><td>0</td></tr> <tr><td>maxOcc</td><td>1</td></tr> <tr><td>content</td><td>simple</td></tr> </table>	isRef	0	minOcc	0	maxOcc	1	content	simple
isRef	0								
minOcc	0								
maxOcc	1								
content	simple								
facets	<table border="0"> <tr><td>Kind</td><td>Value</td><td>annotation</td></tr> <tr><td>pattern</td><td>[1-9]{1}[0-9]*</td><td></td></tr> </table>	Kind	Value	annotation	pattern	[1-9]{1}[0-9]*			
Kind	Value	annotation							
pattern	[1-9]{1}[0-9]*								
source	<pre> <xs:element name="Imponibile" type="cm:DatoNP_Type" minOccurs="0"/> </pre>								

element **Addizionali_Type/AddRegDovuta**

diagram							
namespace	urn:www.agenziaentrate.gov.it:specificheTecniche:sco:730:v1						
type	DatoNP_Type						
properties	<table border="0"> <tr><td>isRef</td><td>0</td></tr> <tr><td>minOcc</td><td>0</td></tr> <tr><td>maxOcc</td><td>1</td></tr> </table>	isRef	0	minOcc	0	maxOcc	1
isRef	0						
minOcc	0						
maxOcc	1						

	content simple
facets	Kind Value annotation pattern [1-9]{1}[0-9]*
source	<code><xs:element name="AddRegDovuta" type="cm:DatoNP_Type" minOccurs="0"/></code>

element **Additionali_Type/AddRegCertif**

diagram	
namespace	urn:www.agenziaentrate.gov.it:specificheTecniche:sco:730:v1
type	DatoNP_Type
properties	isRef 0 minOcc 0 maxOcc 1 content simple
facets	Kind Value annotation pattern [1-9]{1}[0-9]*
source	<code><xs:element name="AddRegCertif" type="cm:DatoNP_Type" minOccurs="0"/></code>

element **Additionali_Type/EccedenzaAddReg**

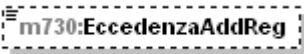
diagram	
namespace	urn:www.agenziaentrate.gov.it:specificheTecniche:sco:730:v1
type	DatoNP_Type
properties	isRef 0 minOcc 0 maxOcc 1 content simple
facets	Kind Value annotation pattern [1-9]{1}[0-9]*
source	<code><xs:element name="EccedenzaAddReg" type="cm:DatoNP_Type" minOccurs="0"/></code>

element **Additionali_Type/AddComDovuta**

diagram	
namespace	urn:www.agenziaentrate.gov.it:specificheTecniche:sco:730:v1
type	DatoNP_Type
properties	isRef 0 minOcc 0 maxOcc 1 content simple
facets	Kind Value annotation pattern [1-9]{1}[0-9]*

source	<code><xs:element name="AddComDovuta" type="cm:DatoNP_Type" minOccurs="0"/></code>
--------	--

element **Additionali_Type/AddComCertif**

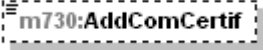
diagram	
namespace	urn:www.agenziaentrate.gov.it:specificheTecniche:sco:730:v1
type	DatoNP_Type
properties	isRef 0 minOcc 0 maxOcc 1 content simple
facets	Kind Value annotation pattern [1-9]{1}[0-9]*
source	<code><xs:element name="AddComCertif" type="cm:DatoNP_Type" minOccurs="0"/></code>

element **Additionali_Type/EccedenzaAddCom**

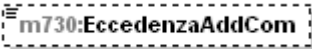
diagram	
namespace	urn:www.agenziaentrate.gov.it:specificheTecniche:sco:730:v1
type	DatoNP_Type
properties	isRef 0 minOcc 0 maxOcc 1 content simple
facets	Kind Value annotation pattern [1-9]{1}[0-9]*
source	<code><xs:element name="EccedenzaAddCom" type="cm:DatoNP_Type" minOccurs="0"/></code>

element **Additionali_Type/AccontoAddCom2012**

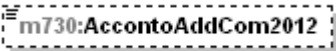
diagram	
namespace	urn:www.agenziaentrate.gov.it:specificheTecniche:sco:730:v1
type	DatoNP_Type
properties	isRef 0 minOcc 0 maxOcc 1 content simple
facets	Kind Value annotation pattern [1-9]{1}[0-9]*
source	<code><xs:element name="AccontoAddCom2012" type="cm:DatoNP_Type" minOccurs="0"/></code>

element **Additionali_Type/AccontoAddCom2012Certif**

diagram	
namespace	urn:www.agenziaentrate.gov.it:specificheTecniche:sco:730:v1
type	DatoNP_Type
properties	isRef 0 minOcc 0 maxOcc 1 content simple
facets	Kind Value annotation pattern [1-9]{1}[0-9]*
source	<pre><xs:element name="AccontoAddCom2012Certif" type="cm:DatoNP_Type" minOccurs="0"/></pre>

complexType **Altre_Detrazioni_Type**

diagram	
namespace	urn:www.agenziaentrate.gov.it:specificheTecniche:sco:730:v1
children	m730:Codice m730:Importo
used by	elements Dati_Altre_Detrazioni_Type/AltreDetrazioni Dati_Altre_Detrazioni_Modulo_Type/AltreDetrazioni
source	<pre><xs:complexType name="Altre_Detrazioni_Type"> <xs:sequence> <xs:element name="Codice" type="m730:Codice_Altre_Detrazioni_Type"/> <xs:element name="Importo" type="cm:DatoNP_Type"/> </xs:sequence> </xs:complexType></pre>

element **Altre_Detrazioni_Type/Codice**

diagram	
namespace	urn:www.agenziaentrate.gov.it:specificheTecniche:sco:730:v1
type	m730:Codice_Altre_Detrazioni_Type
properties	isRef 0 content simple
facets	Kind Value annotation pattern [1-9]{1}[0-9]* enumeration 1 enumeration 2

source	<code><xs:element name="Codice" type="m730:Codice_Altre_Detrazioni_Type"/></code>
--------	---

element **Altre_Detrazioni_Type/Importo**

diagram	
namespace	urn:www.agenziaentrate.gov.it:specificheTecniche:sco:730:v1
type	DatoNP_Type
properties	isRef 0 content simple
facets	Kind Value annotation pattern [1-9]{1}[0-9]*
source	<code><xs:element name="Importo" type="cm:DatoNP_Type"/></code>

complexType **Altre_Ritenute_Type**

diagram	
namespace	urn:www.agenziaentrate.gov.it:specificheTecniche:sco:730:v1
children	m730:AltreRitenuteIrpef m730:AddizionaleRegionale m730:AddizionaleComunale m730:AddRegionaleIrpefAttivitaSport m730:IrpefLavoriSocialmenteUtili m730:AddRegionaleIrpefLavoriSoc Utili
used by	element Primo Modulo Acconti Ritenute_Type/AltreRitenute
source	<pre><xs:complexType name="Altre_Ritenute_Type"> <xs:sequence> <xs:element name="AltreRitenuteIrpef" type="cm:DatoNP_Type" minOccurs="0"/> <xs:element name="AddizionaleRegionale" type="cm:DatoNP_Type" minOccurs="0"/> <xs:element name="AddizionaleComunale" type="cm:DatoNP_Type" minOccurs="0"/> <xs:element name="AddRegionaleIrpefAttivitaSport" type="cm:DatoNP_Type" minOccurs="0"/> <xs:element name="IrpefLavoriSocialmenteUtili" type="cm:DatoNP_Type" minOccurs="0"/> <xs:element name="AddRegionaleIrpefLavoriSoc Utili" type="cm:DatoNP_Type" minOccurs="0"/> </xs:sequence> </xs:complexType></pre>

	<pre> type="cm:DatoNP_Type" minOccurs="0"/> </xs:sequence> </xs:complexType> </pre>
--	--

element **Altre_Ritenute_Type/AltreRitenuteIrpef**

diagram	
namespace	urn:www.agenziaentrate.gov.it:specificheTecniche:sco:730:v1
type	DatoNP_Type
properties	isRef 0 minOcc 0 maxOcc 1 content simple
facets	Kind Value annotation pattern [1-9]{1}[0-9]*
source	<pre> <xs:element name="AltreRitenuteIrpef" type="cm:DatoNP_Type" minOccurs="0"/> </pre>

element **Altre_Ritenute_Type/AddizionaleRegionale**

diagram	
namespace	urn:www.agenziaentrate.gov.it:specificheTecniche:sco:730:v1
type	DatoNP_Type
properties	isRef 0 minOcc 0 maxOcc 1 content simple
facets	Kind Value annotation pattern [1-9]{1}[0-9]*
source	<pre> <xs:element name="AddizionaleRegionale" type="cm:DatoNP_Type" minOccurs="0"/> </pre>

element **Altre_Ritenute_Type/AddizionaleComunale**

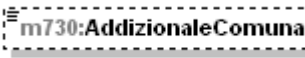
diagram	
namespace	urn:www.agenziaentrate.gov.it:specificheTecniche:sco:730:v1
type	DatoNP_Type
properties	isRef 0 minOcc 0 maxOcc 1 content simple
facets	Kind Value annotation pattern [1-9]{1}[0-9]*
source	<pre> <xs:element name="AddizionaleComunale" type="cm:DatoNP_Type" </pre>

	<code>minOccurs="0"/></code>
--	---------------------------------

element Altre_Ritenute_Type/AddRegionaleIrpefAttivitaSport

diagram	
namespace	urn:www.agenziaentrate.gov.it:specificheTecniche:sco:730:v1
type	DatoNP_Type
properties	isRef 0 minOcc 0 maxOcc 1 content simple
facets	Kind Value annotation pattern [1-9]{1}[0-9]*
source	<code><xs:element name="AddRegionaleIrpefAttivitaSport" type="cm:DatoNP_Type" minOccurs="0"/></code>

element Altre_Ritenute_Type/IrpefLavoriSocialmenteUtili

diagram	
namespace	urn:www.agenziaentrate.gov.it:specificheTecniche:sco:730:v1
type	DatoNP_Type
properties	isRef 0 minOcc 0 maxOcc 1 content simple
facets	Kind Value annotation pattern [1-9]{1}[0-9]*
source	<code><xs:element name="IrpefLavoriSocialmenteUtili" type="cm:DatoNP_Type" minOccurs="0"/></code>

element Altre_Ritenute_Type/AddRegionaleIrpefLavoriSoc_Utili

diagram	
namespace	urn:www.agenziaentrate.gov.it:specificheTecniche:sco:730:v1
type	DatoNP_Type
properties	isRef 0 minOcc 0 maxOcc 1 content simple
facets	Kind Value annotation pattern [1-9]{1}[0-9]*
source	<code><xs:element name="AddRegionaleIrpefLavoriSoc_Utili" type="cm:DatoNP_Type" minOccurs="0"/></code>

complexType Altre_Spese_Type

diagram	
namespace	urn:www.agenziaentrate.gov.it:specificheTecniche:sco:730:v1
children	m730:Codice m730:Importo
used by	elements Detrazioni_Type/AltreSpese Detrazioni_Modulo_Type/AltreSpese
source	<pre><xs:complexType name="Altre_Spese_Type"> <xs:sequence> <xs:element name="Codice" type="m730:Codice_Altre_Spese_Type"/> <xs:element name="Importo" type="cm:DatoNP_Type"/> </xs:sequence> </xs:complexType></pre>

element Altre_Spese_Type/Codice

diagram																																																													
namespace	urn:www.agenziaentrate.gov.it:specificheTecniche:sco:730:v1																																																												
type	m730:Codice_Altre_Spese_Type																																																												
properties	isRef 0 content simple																																																												
facets	<table border="1"> <thead> <tr> <th>Kind</th> <th>Value</th> <th>annotation</th> </tr> </thead> <tbody> <tr> <td>pattern</td> <td>[1-9]{1}[0-9]*</td> <td></td> </tr> <tr><td>enumeration</td><td>17</td><td></td></tr> <tr><td>enumeration</td><td>18</td><td></td></tr> <tr><td>enumeration</td><td>19</td><td></td></tr> <tr><td>enumeration</td><td>20</td><td></td></tr> <tr><td>enumeration</td><td>21</td><td></td></tr> <tr><td>enumeration</td><td>22</td><td></td></tr> <tr><td>enumeration</td><td>23</td><td></td></tr> <tr><td>enumeration</td><td>24</td><td></td></tr> <tr><td>enumeration</td><td>25</td><td></td></tr> <tr><td>enumeration</td><td>26</td><td></td></tr> <tr><td>enumeration</td><td>27</td><td></td></tr> <tr><td>enumeration</td><td>28</td><td></td></tr> <tr><td>enumeration</td><td>29</td><td></td></tr> <tr><td>enumeration</td><td>30</td><td></td></tr> <tr><td>enumeration</td><td>31</td><td></td></tr> <tr><td>enumeration</td><td>32</td><td></td></tr> <tr><td>enumeration</td><td>33</td><td></td></tr> <tr><td>enumeration</td><td>34</td><td></td></tr> </tbody> </table>	Kind	Value	annotation	pattern	[1-9]{1}[0-9]*		enumeration	17		enumeration	18		enumeration	19		enumeration	20		enumeration	21		enumeration	22		enumeration	23		enumeration	24		enumeration	25		enumeration	26		enumeration	27		enumeration	28		enumeration	29		enumeration	30		enumeration	31		enumeration	32		enumeration	33		enumeration	34	
Kind	Value	annotation																																																											
pattern	[1-9]{1}[0-9]*																																																												
enumeration	17																																																												
enumeration	18																																																												
enumeration	19																																																												
enumeration	20																																																												
enumeration	21																																																												
enumeration	22																																																												
enumeration	23																																																												
enumeration	24																																																												
enumeration	25																																																												
enumeration	26																																																												
enumeration	27																																																												
enumeration	28																																																												
enumeration	29																																																												
enumeration	30																																																												
enumeration	31																																																												
enumeration	32																																																												
enumeration	33																																																												
enumeration	34																																																												

source	<code><xs:element name="Codice" type="m730:Codice_Altre_Spese_Type"/></code>
--------	--

element Altre_Spese_Type/Importo

diagram	
namespace	urn:www.agenziaentrate.gov.it:specificheTecniche:sco:730:v1
type	DatoNP_Type
properties	isRef 0 content simple
facets	Kind Value annotation pattern [1-9]{1}[0-9]*
source	<code><xs:element name="Importo" type="cm:DatoNP_Type"/></code>

complexType Altri_Dati_Type

diagram	
namespace	urn:www.agenziaentrate.gov.it:specificheTecniche:sco:730:v1
children	m730:ResiduoCreditoPrimaCasa m730:ResiduoCreditoOccupazione m730:ResiduoCreditoSisma m730:ResiduoCreditoFondiPensione m730:ResiduoCreditoMediazioni m730:TotSpeseSanitarieRateizzate m730:RedditoAgevolazioniFiscali
used by	element Primo Modulo PL_Type/AltriDati
source	<pre><xs:complexType name="Altri_Dati_Type"> <xs:sequence> <xs:element name="ResiduoCreditoPrimaCasa" type="cm:DatoNP_Type" minOccurs="0"/> <xs:element name="ResiduoCreditoOccupazione" type="cm:DatoNP_Type" minOccurs="0"/> <xs:element name="ResiduoCreditoSisma" type="cm:DatoNP_Type" minOccurs="0"/> <xs:element name="ResiduoCreditoFondiPensione" type="cm:DatoNP_Type" minOccurs="0"/> </xs:sequence> </xs:complexType></pre>

	<pre> <xs:element name="ResiduoCreditoMediazioni" type="cm:DatoNP_Type" minOccurs="0"/> <xs:element name="TotSpeseSanitarieRateizzate" type="cm:DatoNP_Type" minOccurs="0"/> <xs:element name="RedditoAgevolazioniFiscali" type="cm:DatoNP_Type" minOccurs="0"/> </xs:sequence> </xs:complexType> </pre>
--	--

element Altri_Dati_Type/ResiduoCreditoPrimaCasa

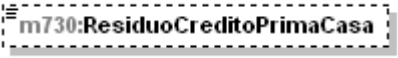
diagram									
namespace	urn:www.agenziaentrate.gov.it:specificheTecniche:sco:730:v1								
type	DatoNP_Type								
properties	<table border="0"> <tr><td>isRef</td><td>0</td></tr> <tr><td>minOcc</td><td>0</td></tr> <tr><td>maxOcc</td><td>1</td></tr> <tr><td>content</td><td>simple</td></tr> </table>	isRef	0	minOcc	0	maxOcc	1	content	simple
isRef	0								
minOcc	0								
maxOcc	1								
content	simple								
facets	<table border="0"> <tr><td>Kind</td><td>Value</td><td>annotation</td></tr> <tr><td>pattern</td><td>[1-9]{1}[0-9]*</td><td></td></tr> </table>	Kind	Value	annotation	pattern	[1-9]{1}[0-9]*			
Kind	Value	annotation							
pattern	[1-9]{1}[0-9]*								
source	<pre> <xs:element name="ResiduoCreditoPrimaCasa" type="cm:DatoNP_Type" minOccurs="0"/> </pre>								

element Altri_Dati_Type/ResiduoCreditoOccupazione

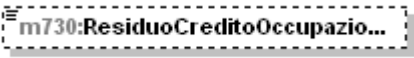
diagram									
namespace	urn:www.agenziaentrate.gov.it:specificheTecniche:sco:730:v1								
type	DatoNP_Type								
properties	<table border="0"> <tr><td>isRef</td><td>0</td></tr> <tr><td>minOcc</td><td>0</td></tr> <tr><td>maxOcc</td><td>1</td></tr> <tr><td>content</td><td>simple</td></tr> </table>	isRef	0	minOcc	0	maxOcc	1	content	simple
isRef	0								
minOcc	0								
maxOcc	1								
content	simple								
facets	<table border="0"> <tr><td>Kind</td><td>Value</td><td>annotation</td></tr> <tr><td>pattern</td><td>[1-9]{1}[0-9]*</td><td></td></tr> </table>	Kind	Value	annotation	pattern	[1-9]{1}[0-9]*			
Kind	Value	annotation							
pattern	[1-9]{1}[0-9]*								
source	<pre> <xs:element name="ResiduoCreditoOccupazione" type="cm:DatoNP_Type" minOccurs="0"/> </pre>								

element Altri_Dati_Type/ResiduoCreditoSisma

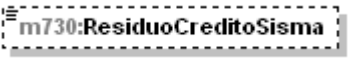
diagram					
namespace	urn:www.agenziaentrate.gov.it:specificheTecniche:sco:730:v1				
type	DatoNP_Type				
properties	<table border="0"> <tr><td>isRef</td><td>0</td></tr> <tr><td>minOcc</td><td>0</td></tr> </table>	isRef	0	minOcc	0
isRef	0				
minOcc	0				

	maxOcc 1 content simple
facets	Kind Value annotation pattern [1-9]{1}[0-9]*
source	<code><xs:element name="ResiduoCreditoSisma" type="cm:DatoNP_Type" minOccurs="0"/></code>

element Altri_Dati_Type/ResiduoCreditoFondiPensione

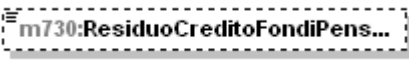
diagram	
namespace	urn:www.agenziaentrate.gov.it:specificheTecniche:sco:730:v1
type	DatoNP_Type
properties	isRef 0 minOcc 0 maxOcc 1 content simple
facets	Kind Value annotation pattern [1-9]{1}[0-9]*
source	<code><xs:element name="ResiduoCreditoFondiPensione" type="cm:DatoNP_Type" minOccurs="0"/></code>

element Altri_Dati_Type/ResiduoCreditoMediazioni

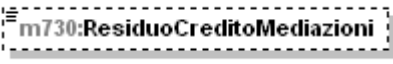
diagram	
namespace	urn:www.agenziaentrate.gov.it:specificheTecniche:sco:730:v1
type	DatoNP_Type
properties	isRef 0 minOcc 0 maxOcc 1 content simple
facets	Kind Value annotation pattern [1-9]{1}[0-9]*
source	<code><xs:element name="ResiduoCreditoMediazioni" type="cm:DatoNP_Type" minOccurs="0"/></code>

element Altri_Dati_Type/TotSpeseSanitarieRateizzate

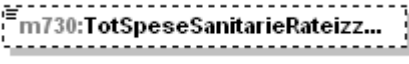
diagram	
namespace	urn:www.agenziaentrate.gov.it:specificheTecniche:sco:730:v1
type	DatoNP_Type
properties	isRef 0 minOcc 0 maxOcc 1 content simple
facets	Kind Value annotation

	pattern [1-9]{1}[0-9]*
source	<code><xs:element name="TotSpeseSanitarieRateizzate" type="cm:DatoNP_Type" minOccurs="0"/></code>

element Altri_Dati_Type/RedditoAgevolazioniFiscali

diagram	
namespace	urn:www.agenziaentrate.gov.it:specificheTecniche:sco:730:v1
type	DatoNP_Type
properties	isRef 0 minOcc 0 maxOcc 1 content simple
facets	Kind Value annotation pattern [1-9]{1}[0-9]*
source	<code><xs:element name="RedditoAgevolazioniFiscali" type="cm:DatoNP_Type" minOccurs="0"/></code>

complexType Altri_Oneri_Type

diagram	
namespace	urn:www.agenziaentrate.gov.it:specificheTecniche:sco:730:v1
children	m730:Codice m730:Importo
used by	elements Deduzioni_Type/AltriOneri Deduzioni_Modulo_Type/AltriOneri
source	<code><xs:complexType name="Altri_Oneri_Type"> <xs:sequence> <xs:element name="Codice" type="m730:Codice_Altri_Oneri_Type"/> <xs:element name="Importo" type="cm:DatoNP_Type"/> </xs:sequence> </xs:complexType></code>

element Altri_Oneri_Type/Codice

diagram	
namespace	urn:www.agenziaentrate.gov.it:specificheTecniche:sco:730:v1
type	m730:Codice Altri_Oneri_Type
properties	isRef 0 content simple

facets	Kind pattern	Value [1-9]{1}[0-9]*	annotation
	enumeration	1	
	enumeration	2	
	enumeration	3	
	enumeration	4	
	enumeration	5	
source	<pre><xs:element name="Codice" type="m730:Codice_Altri_Oneri_Type"/></pre>		

element Altri_Oneri_Type/Importo

diagram			
namespace	urn:www.agenziaentrate.gov.it:specificheTecniche:sco:730:v1		
type	DatoNP_Type		
properties	isRef	0	
	content	simple	
facets	Kind pattern	Value [1-9]{1}[0-9]*	annotation
source	<pre><xs:element name="Importo" type="cm:DatoNP_Type"/></pre>		

complexType Altri_Reddito_Ass_Lavd_Type

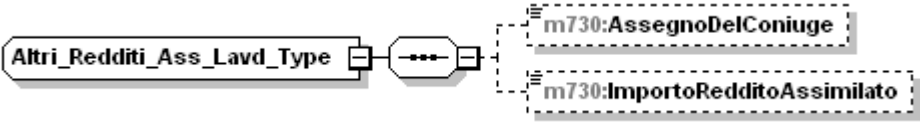
diagram			
namespace	urn:www.agenziaentrate.gov.it:specificheTecniche:sco:730:v1		
children	m730:AssegnoDelConiuge m730:ImportoRedditoAssimilato		
used by	elements	Primo Modulo Lavoro Dip_Type/AltriRedditiAssLavDip Modulo Lavoro Dip_Type/AltriRedditiAssLavDip	
source	<pre><xs:complexType name="Altri_Reddito_Ass_Lavd_Type"> <xs:sequence> <xs:element name="AssegnoDelConiuge" type="cm:DatoCB_Type" minOccurs="0"/> <xs:element name="ImportoRedditoAssimilato" type="cm:DatoNP_Type" minOccurs="0"/> </xs:sequence> </xs:complexType></pre>		

element Altri_Reddito_Ass_Lavd_Type/AssegnoDelConiuge

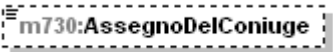
diagram			
---------	---	--	--

namespace	urn:www.agenziaentrate.gov.it:specificheTecniche:sco:730:v1
type	DatoCB_Type
properties	isRef 0 minOcc 0 maxOcc 1 content simple
facets	Kind Value annotation pattern [01]
source	<pre><xs:element name="AssegnoDelConiuge" type="cm:DatoCB_Type" minOccurs="0"/></pre>

element Altri_Reddito_Ass_Lavd_Type/ImportoRedditoAssimilato

diagram	
namespace	urn:www.agenziaentrate.gov.it:specificheTecniche:sco:730:v1
type	DatoNP_Type
properties	isRef 0 minOcc 0 maxOcc 1 content simple
facets	Kind Value annotation pattern [1-9]{1}[0-9]*
source	<pre><xs:element name="ImportoRedditoAssimilato" type="cm:DatoNP_Type" minOccurs="0"/></pre>

complexType Altri_Reddito_Diversi_Detr_Type

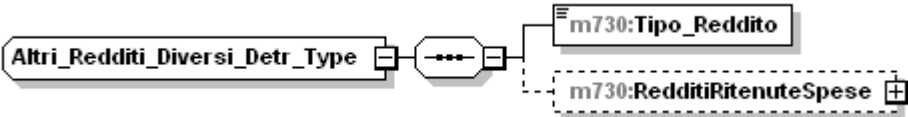
diagram	
namespace	urn:www.agenziaentrate.gov.it:specificheTecniche:sco:730:v1
children	m730:Tipo_Reddito m730:RedditiRitenuteSpese
used by	element Redditi_Capitale_Type/RedditiDiversiDetraz
source	<pre><xs:complexType name="Altri_Reddito_Diversi_Detr_Type"> <xs:sequence> <xs:element name="Tipo_Reddito" type="m730:Tipo_Reddito_Dala3_Type"/> <xs:element name="RedditiRitenuteSpese" type="m730:Redditi_Ritenute_Spese_Type" minOccurs="0"/> </xs:sequence> </xs:complexType></pre>

element **Altri_Reddito_Diversi_Detr_Type/Tipo_Reddito**

diagram	
namespace	urn:www.agenziaentrate.gov.it:specificheTecniche:sco:730:v1
type	m730:Tipo_Reddito_Da1a3_Type
properties	isRef 0 content simple
facets	Kind Value annotation maxLength 1 pattern [1-9] enumeration 1 enumeration 2 enumeration 3
source	<pre><xs:element name="Tipo_Reddito" type="m730:Tipo_Reddito_Da1a3_Type"/></pre>

element **Altri_Reddito_Diversi_Detr_Type/RedditiRitenuteSpese**

diagram	
namespace	urn:www.agenziaentrate.gov.it:specificheTecniche:sco:730:v1
type	m730:Redditi_Ritenute_Spese_Type
properties	isRef 0 minOcc 0 maxOcc 1 content complex
children	m730:ImportoRedditi m730:ImportoRitenute m730:ImportoSpese
source	<pre><xs:element name="RedditiRitenuteSpese" type="m730:Redditi_Ritenute_Spese_Type" minOccurs="0"/></pre>

complexType **Altri_Reddito_Diversi_Type**

diagram	
namespace	urn:www.agenziaentrate.gov.it:specificheTecniche:sco:730:v1
children	m730:TipoReddito m730:RedditiRitenuteSpese
used by	element Redditi_Capitale_Type/RedditiDiversi

source	<pre> <xs:complexType name="Altri_Redditi_Diversi_Type"> <xs:sequence> <xs:element name="TipoReddito" type="m730:Tipo_Reddito_Dala7_Type"/> <xs:element name="RedditiRitenuteSpese" type="m730:Redditi_Ritenute_Spese_Type" minOccurs="0"/> </xs:sequence> </xs:complexType> </pre>
--------	---

element Altri_Redditi_Diversi_Type/TipoReddito

diagram																															
namespace	urn:www.agenziaentrate.gov.it:specificheTecniche:sco:730:v1																														
type	m730:Tipo_Reddito_Dala7_Type																														
properties	isRef 0 content simple																														
facets	<table border="1"> <thead> <tr> <th>Kind</th> <th>Value</th> <th>annotation</th> </tr> </thead> <tbody> <tr> <td>maxLength</td> <td>1</td> <td></td> </tr> <tr> <td>pattern</td> <td>[1-9]</td> <td></td> </tr> <tr> <td>enumeration</td> <td>1</td> <td></td> </tr> <tr> <td>enumeration</td> <td>2</td> <td></td> </tr> <tr> <td>enumeration</td> <td>3</td> <td></td> </tr> <tr> <td>enumeration</td> <td>4</td> <td></td> </tr> <tr> <td>enumeration</td> <td>5</td> <td></td> </tr> <tr> <td>enumeration</td> <td>6</td> <td></td> </tr> <tr> <td>enumeration</td> <td>7</td> <td></td> </tr> </tbody> </table>	Kind	Value	annotation	maxLength	1		pattern	[1-9]		enumeration	1		enumeration	2		enumeration	3		enumeration	4		enumeration	5		enumeration	6		enumeration	7	
Kind	Value	annotation																													
maxLength	1																														
pattern	[1-9]																														
enumeration	1																														
enumeration	2																														
enumeration	3																														
enumeration	4																														
enumeration	5																														
enumeration	6																														
enumeration	7																														
source	<pre> <xs:element name="TipoReddito" type="m730:Tipo_Reddito_Dala7_Type"/> </pre>																														

element Altri_Redditi_Diversi_Type/RedditiRitenuteSpese

diagram	
namespace	urn:www.agenziaentrate.gov.it:specificheTecniche:sco:730:v1
type	m730:Redditi_Ritenute_Spese_Type
properties	isRef 0 minOcc 0 maxOcc 1 content complex

children	m730:ImportoRedditi m730:ImportoRitenute m730:ImportoSpese
source	<pre><xs:element name="RedditiRitenuteSpese" type="m730:Redditi_Ritenute_Spese_Type" minOccurs="0"/></pre>

complexType Altri_Redditi_Lavoro_Autonomo_Type

diagram	
namespace	urn:www.agenziaentrate.gov.it:specificheTecniche:sco:730:v1
children	m730:TipoReddito m730:RedditiRitenute
used by	element Redditi_Capitale_Type/LavoroAutonomo
source	<pre><xs:complexType name="Altri_Redditi_Lavoro_Autonomo_Type"> <xs:sequence> <xs:element name="TipoReddito" type="m730:Tipo_Reddito_Da1a3_Type"/> <xs:element name="RedditiRitenute" type="m730:Redditi_Ritenute_Type" minOccurs="0"/> </xs:sequence> </xs:complexType></pre>

element Altri_Redditi_Lavoro_Autonomo_Type/TipoReddito

diagram																			
namespace	urn:www.agenziaentrate.gov.it:specificheTecniche:sco:730:v1																		
type	m730:Tipo_Reddito_Da1a3_Type																		
properties	isRef 0 content simple																		
facets	<table border="1"> <thead> <tr> <th>Kind</th> <th>Value</th> <th>annotation</th> </tr> </thead> <tbody> <tr> <td>maxLength</td> <td>1</td> <td></td> </tr> <tr> <td>pattern</td> <td>[1-9]</td> <td></td> </tr> <tr> <td>enumeration</td> <td>1</td> <td></td> </tr> <tr> <td>enumeration</td> <td>2</td> <td></td> </tr> <tr> <td>enumeration</td> <td>3</td> <td></td> </tr> </tbody> </table>	Kind	Value	annotation	maxLength	1		pattern	[1-9]		enumeration	1		enumeration	2		enumeration	3	
Kind	Value	annotation																	
maxLength	1																		
pattern	[1-9]																		
enumeration	1																		
enumeration	2																		
enumeration	3																		
source	<pre><xs:element name="TipoReddito" type="m730:Tipo_Reddito_Da1a3_Type"/></pre>																		

element Altri_Reddito_Lavoro_Autonomo_Type/RedditoRitenute

diagram	
namespace	urn:www.agenziaentrate.gov.it:specificheTecniche:sco:730:v1
type	m730:RedditoRitenute_Type
properties	isRef 0 minOcc 0 maxOcc 1 content complex
children	m730:ImportoReddito m730:ImportoRitenute
source	<pre><xs:element name="RedditoRitenute" type="m730:RedditoRitenute_Type" minOccurs="0"/></pre>

complexType Altri_Reddito_Type

diagram	
namespace	urn:www.agenziaentrate.gov.it:specificheTecniche:sco:730:v1
children	m730:Modulo
used by	element Dati Contabili Type/QuadroD
annotation	documentation Quadro D - Altri Redditi
source	<pre><xs:complexType name="Altri_Reddito_Type"> <xs:annotation> <xs:documentation>Quadro D - Altri Redditi</xs:documentation> </xs:annotation> <xs:sequence> <xs:element name="Modulo" type="m730:Modulo_Altri_Reddito_Type" maxOccurs="unbounded"/> </xs:sequence> </xs:complexType></pre>

element Altri_Reddito_Type/Modulo

diagram	
namespace	urn:www.agenziaentrate.gov.it:specificheTecniche:sco:730:v1
type	m730:Modulo_Altri_Reddito_Type
properties	isRef 0 minOcc 1 maxOcc unbounded content complex
children	m730:RedditiDiCapitale m730:RedditiTassazioneSeparata
source	<pre><xs:element name="Modulo" type="m730:Modulo_Altri_Reddito_Type" maxOccurs="unbounded"/></pre>

complexType Altri_Reddito_Utili_Type

diagram	
namespace	urn:www.agenziaentrate.gov.it:specificheTecniche:sco:730:v1
children	m730:Tipo_Reddito m730:RedditiRitenute
used by	element Redditi_Capitale_Type/Utili
source	<pre><xs:complexType name="Altri_Reddito_Utili_Type"> <xs:sequence> <xs:element name="Tipo_Reddito" type="m730:Tipo_Reddito_Da1a6_Type"/> <xs:element name="RedditiRitenute" type="m730:Redditi_Ritenute_Type" minOccurs="0"/> </xs:sequence> </xs:complexType></pre>

element Altri_Reddito_Utili_Type/Tipo_Reddito

diagram							
namespace	urn:www.agenziaentrate.gov.it:specificheTecniche:sco:730:v1						
type	m730:Tipo_Reddito_Da1a6_Type						
properties	isRef 0 content simple						
facets	<table border="1"> <thead> <tr> <th>Kind</th> <th>Value</th> <th>annotation</th> </tr> </thead> <tbody> <tr> <td>maxLength</td> <td>1</td> <td></td> </tr> </tbody> </table>	Kind	Value	annotation	maxLength	1	
Kind	Value	annotation					
maxLength	1						

	pattern [1-9] enumeration 1 enumeration 2 enumeration 3 enumeration 4 enumeration 5 enumeration 6
source	<pre><xs:element name="Tipo_Reddito" type="m730:Tipo_Reddito_Dala6_Type"/></pre>

element Altri_Redditi_Utili_Type/RedditiRitenute

diagram	
namespace	urn:www.agenziaentrate.gov.it:specificheTecniche:sco:730:v1
type	m730:Redditi_Ritenute_Type
properties	isRef 0 minOcc 0 maxOcc 1 content complex
children	m730:ImportoRedditi m730:ImportoRitenute
source	<pre><xs:element name="RedditiRitenute" type="m730:Redditi_Ritenute_Type" minOccurs="0"/></pre>

complexType Annotazioni_Prospetto_Type

diagram	
namespace	urn:www.agenziaentrate.gov.it:specificheTecniche:sco:730:v1
children	m730:Codice m730:RigoQuadro m730:ModuloQuadro m730:Importo
used by	element Dati_Contabili_Type/Annotazioni
source	<pre><xs:complexType name="Annotazioni_Prospetto_Type"> <xs:sequence> <xs:element name="Codice" type="cm:DatoAN_Type"/> <xs:element name="RigoQuadro" type="cm:DatoNP_Type"/> </xs:sequence> </xs:complexType></pre>

	<pre> <xs:element name="ModuloQuadro" type="cm:DatoNP_Type"/> <xs:element name="Importo" type="cm:DatoNP_Type" minOccurs="0"/> </xs:sequence> </xs:complexType> </pre>
--	--

element Annotazioni_Prospetto_Type/Codice

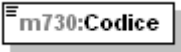
diagram	
namespace	urn:www.agenziaentrate.gov.it:specificheTecniche:sco:730:v1
type	DatoAN_Type
properties	isRef 0 content simple
facets	Kind Value annotation pattern [0-9A-Z]{1}([0-9A-Z] \- \. & _ / \° \^ \()*)
source	<pre><xs:element name="Codice" type="cm:DatoAN_Type"/></pre>

element Annotazioni_Prospetto_Type/RigoQuadro

diagram	
namespace	urn:www.agenziaentrate.gov.it:specificheTecniche:sco:730:v1
type	DatoNP_Type
properties	isRef 0 content simple
facets	Kind Value annotation pattern [1-9]{1}[0-9]*
source	<pre><xs:element name="RigoQuadro" type="cm:DatoNP_Type"/></pre>

element Annotazioni_Prospetto_Type/ModuloQuadro

diagram	
namespace	urn:www.agenziaentrate.gov.it:specificheTecniche:sco:730:v1
type	DatoNP_Type
properties	isRef 0 content simple
facets	Kind Value annotation pattern [1-9]{1}[0-9]*
source	<pre><xs:element name="ModuloQuadro" type="cm:DatoNP_Type"/></pre>

element **Annotazioni_Prospetto_Type/Importo**

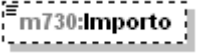
diagram	
namespace	urn:www.agenziaentrate.gov.it:specificheTecniche:sco:730:v1
type	DatoNP_Type
properties	isRef 0 minOcc 0 maxOcc 1 content simple
facets	Kind Value annotation pattern [1-9]{1}[0-9]*
source	<pre><xs:element name="Importo" type="cm:DatoNP_Type" minOccurs="0"/></pre>

complexType **Assegno_Coniuge_Type**

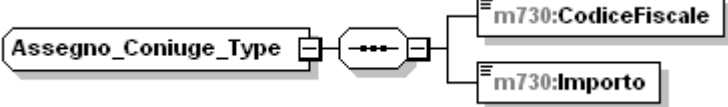
diagram	
namespace	urn:www.agenziaentrate.gov.it:specificheTecniche:sco:730:v1
children	m730:CodiceFiscale m730:Importo
used by	elements Deduzioni_Type/AssegnoConiuge Deduzioni_Modulo_Type/AssegnoConiuge
source	<pre><xs:complexType name="Assegno_Coniuge_Type"> <xs:sequence> <xs:element name="CodiceFiscale" type="cm:DatoCF_Type"/> <xs:element name="Importo" type="cm:DatoNP_Type"/> </xs:sequence> </xs:complexType></pre>

element **Assegno_Coniuge_Type/CodiceFiscale**

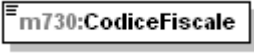
diagram	
namespace	urn:www.agenziaentrate.gov.it:specificheTecniche:sco:730:v1
type	DatoCF_Type
properties	isRef 0 content simple
facets	Kind Value annotation pattern [0-9]{11}[A-Z]{6}[0-9LMNPQRSTUVWXYZ]{2}[A-Z]{1}[0-9LMNPQRSTUVWXYZ]{2}[A-Z]{1}[0-9LMNPQRSTUVWXYZ]{3}[A-Z]{1}
source	<pre><xs:element name="CodiceFiscale" type="cm:DatoCF_Type"/></pre>

element **Assegno_Coniuge_Type/Importo**

diagram	
namespace	urn:www.agenziaentrate.gov.it:specificheTecniche:sco:730:v1
type	DatoNP_Type
properties	isRef 0 content simple
facets	Kind Value annotation pattern [1-9]{1}[0-9]*
source	<code><xs:element name="Importo" type="cm:DatoNP_Type"/></code>

complexType **Casella_Acconto_Type**

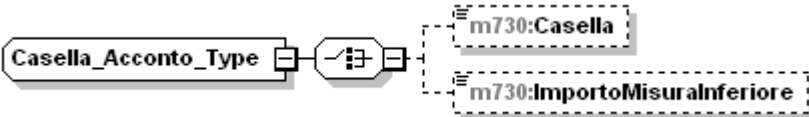
diagram	
namespace	urn:www.agenziaentrate.gov.it:specificheTecniche:sco:730:v1
children	m730:Casella m730:ImportoMisuralInferiore
used by	elements Misura_Acconti_Type/AddComunaleMisuralInferiore Misura_Acconti_Type/CedolareSeccaMisuralInferiore Misura_Acconti_Type/IrpefMisuralInferiore
source	<pre><xs:complexType name="Casella_Acconto_Type"> <xs:choice> <xs:element name="Casella" type="cm:DatoCB_Type" minOccurs="0"/> <xs:element name="ImportoMisuraInferiore" type="cm:DatoNP_Type" minOccurs="0"/> </xs:choice> </xs:complexType></pre>

element **Casella_Acconto_Type/Casella**

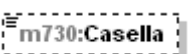
diagram	
namespace	urn:www.agenziaentrate.gov.it:specificheTecniche:sco:730:v1
type	DatoCB_Type
properties	isRef 0 minOcc 0 maxOcc 1 content simple
facets	Kind Value annotation pattern [01]
source	<code><xs:element name="Casella" type="cm:DatoCB_Type" minOccurs="0"/></code>

element **Casella_Acconto_Type/ImportoMisuraInferiore**

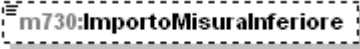
diagram	
namespace	urn:www.agenziaentrate.gov.it:specificheTecniche:sco:730:v1
type	DatoNP_Type
properties	isRef 0 minOcc 0 maxOcc 1 content simple
facets	Kind Value annotation pattern [1-9]{1}[0-9]*
source	<pre><xs:element name="ImportoMisuraInferiore" type="cm:DatoNP_Type" minOccurs="0"/></pre>

complexType **Cedolare_Secca_Type**

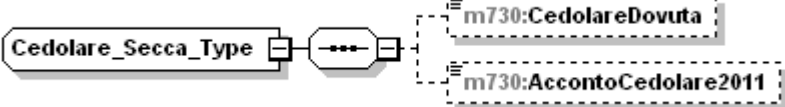
diagram	
namespace	urn:www.agenziaentrate.gov.it:specificheTecniche:sco:730:v1
children	m730:CedolareDovuta m730:AccontoCedolare2011
used by	element Primo Modulo_PL_Type/CedolareSecca
source	<pre><xs:complexType name="Cedolare_Secca_Type"> <xs:sequence> <xs:element name="CedolareDovuta" type="cm:DatoNP_Type" minOccurs="0"/> <xs:element name="AccontoCedolare2011" type="cm:DatoNP_Type" minOccurs="0"/> </xs:sequence> </xs:complexType></pre>

element **Cedolare_Secca_Type/CedolareDovuta**

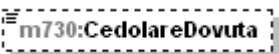
diagram	
namespace	urn:www.agenziaentrate.gov.it:specificheTecniche:sco:730:v1
type	DatoNP_Type
properties	isRef 0 minOcc 0 maxOcc 1 content simple
facets	Kind Value annotation pattern [1-9]{1}[0-9]*
source	<pre><xs:element name="CedolareDovuta" type="cm:DatoNP_Type" minOccurs="0"/></pre>

element **Cedolare_Secca_Type/AcontoCedolare2011**

diagram	
namespace	urn:www.agenziaentrate.gov.it:specificheTecniche:sco:730:v1
type	DatoNP_Type
properties	isRef 0 minOcc 0 maxOcc 1 content simple
facets	Kind Value annotation pattern [1-9]{1}[0-9]*
source	<pre><xs:element name="AcontoCedolare2011" type="cm:DatoNP_Type" minOccurs="0"/></pre>

complexType **Contributi_Previdenza_Complementare_Type**

diagram	
namespace	urn:www.agenziaentrate.gov.it:specificheTecniche:sco:730:v1
children	m730:EsclusiDalSostituto m730:NonEsclusiDalSostituto
used by	elements Fondo Pensione Dipendenti Pubblici Type/Contributi Deduzioni Type/Deducibilita Ordinaria Deduzioni Type/Familiari A Carico Deduzioni Type/Fondi In Squilibrio Finanziario Deduzioni Type/Lavoratori Prima Occupazione
source	<pre><xs:complexType name="Contributi_Previdenza_Complementare_Type"> <xs:sequence> <xs:element name="EsclusiDalSostituto" type="cm:DatoNP_Type"/> <xs:element name="NonEsclusiDalSostituto" type="cm:DatoNP_Type"/> </xs:sequence> </xs:complexType></pre>

element **Contributi_Previdenza_Complementare_Type/EsclusiDalSostituto**

diagram	
namespace	urn:www.agenziaentrate.gov.it:specificheTecniche:sco:730:v1
type	DatoNP_Type
properties	isRef 0 content simple
facets	Kind Value annotation pattern [1-9]{1}[0-9]*

source	<code><xs:element name="EsclusiDalSostituto" type="cm:DatoNP_Type"/></code>
--------	---

element **Contributi_Previdenza_Complementare_Type/NonEsclusiDalSostituto**

diagram	
namespace	urn:www.agenziaentrate.gov.it:specificheTecniche:sco:730:v1
type	DatoNP_Type
properties	isRef 0 content simple
facets	Kind Value annotation pattern [1-9]{1}[0-9]*
source	<code><xs:element name="NonEsclusiDalSostituto" type="cm:DatoNP_Type"/></code>

complexType **Contributo_Solidarietà_Type**

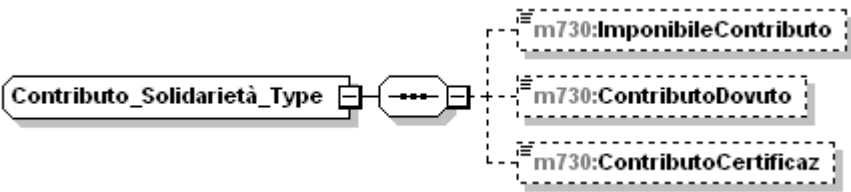
diagram	
namespace	urn:www.agenziaentrate.gov.it:specificheTecniche:sco:730:v1
children	m730:ImponibileContributo m730:ContributoDovuto m730:ContributoCertificaz
used by	element Primo Modulo_PL_Type/ContributoSolidarietà
source	<pre><xs:complexType name="Contributo_Solidarietà_Type"> <xs:sequence> <xs:element name="ImponibileContributo" type="cm:DatoNP_Type" minOccurs="0"/> <xs:element name="ContributoDovuto" type="cm:DatoNP_Type" minOccurs="0"/> <xs:element name="ContributoCertificaz" type="cm:DatoNP_Type" minOccurs="0"/> </xs:sequence> </xs:complexType></pre>

element **Contributo_Solidarietà_Type/ImponibileContributo**

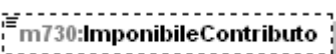
diagram	
namespace	urn:www.agenziaentrate.gov.it:specificheTecniche:sco:730:v1
type	DatoNP_Type

properties	isRef 0 minOcc 0 maxOcc 1 content simple
facets	Kind Value annotation pattern [1-9]{1}[0-9]*
source	<code><xs:element name="ImponibileContributo" type="cm:DatoNP_Type" minOccurs="0"/></code>

element Contributo_Solidarietà_Type/ContributoDovuto

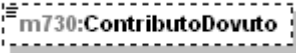
diagram	
namespace	urn:www.agenziaentrate.gov.it:specificheTecniche:sco:730:v1
type	DatoNP_Type
properties	isRef 0 minOcc 0 maxOcc 1 content simple
facets	Kind Value annotation pattern [1-9]{1}[0-9]*
source	<code><xs:element name="ContributoDovuto" type="cm:DatoNP_Type" minOccurs="0"/></code>

element Contributo_Solidarietà_Type/ContributoCertificaz

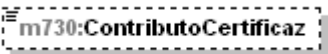
diagram	
namespace	urn:www.agenziaentrate.gov.it:specificheTecniche:sco:730:v1
type	DatoNP_Type
properties	isRef 0 minOcc 0 maxOcc 1 content simple
facets	Kind Value annotation pattern [1-9]{1}[0-9]*
source	<code><xs:element name="ContributoCertificaz" type="cm:DatoNP_Type" minOccurs="0"/></code>

complexType Cred_Imp_Estero_Type

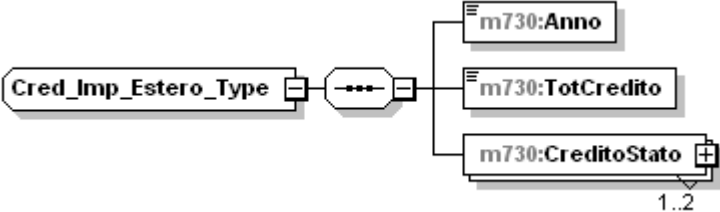
diagram	 <pre> graph LR Cred_Imp_Estero_Type --> m730_Anno[m730:Anno] Cred_Imp_Estero_Type --> m730_TotCredito[m730:TotCredito] Cred_Imp_Estero_Type --> m730_CreditoStato[m730:CreditoStato] m730_CreditoStato --- 1..2 </pre>
---------	--

namespace	urn:www.agenziaentrate.gov.it:specificheTecniche:sco:730:v1
children	m730:Anno m730:TotCredito m730:CreditoStato
used by	elements Primo Modulo PL Type/CredImpEsteri Modulo PL Type/CredImpEsteri
source	<pre> <xs:complexType name="Cred_Imp_Estero_Type"> <xs:sequence> <xs:element name="Anno" type="cm:DatoDN_Type"/> <xs:element name="TotCredito" type="cm:DatoNP_Type"/> <xs:element name="CreditoStato" type="m730:Credito_Stato_Type" maxOccurs="2"/> </xs:sequence> </xs:complexType> </pre>

element Cred_Imp_Estero_Type/Anno

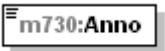
diagram	
namespace	urn:www.agenziaentrate.gov.it:specificheTecniche:sco:730:v1
type	DatoDN_Type
properties	isRef 0 content simple
facets	Kind Value annotation length 8 pattern (((([0-9]{12}[0-9]{3}[01])(0[13578][10]12)\d{4})) ((([0-9]{12}[0-9]{30}(0[469][11]\d{4})) ((0[1-9][10-9]{2}[0-8])(02)\d{4})) ((29)(02)([02468][048]00)) ((29)(02)([13579][26]00)) ((29)(02)([0-9][0-9][0][48])) ((29)(02)([0-9][0-9][2468][048])) ((29)(02)([0-9][0-9][13579][26]))))
source	<pre><xs:element name="Anno" type="cm:DatoDN_Type"/></pre>

element Cred_Imp_Estero_Type/TotCredito

diagram	
namespace	urn:www.agenziaentrate.gov.it:specificheTecniche:sco:730:v1
type	DatoNP_Type
properties	isRef 0 content simple
facets	Kind Value annotation pattern [1-9]{1}[0-9]*
source	<pre><xs:element name="TotCredito" type="cm:DatoNP_Type"/></pre>

element Cred_Imp_Estero_Type/CreditoStato

diagram	
namespace	urn:www.agenziaentrate.gov.it:specificheTecniche:sco:730:v1
type	m730:Credito_Stato_Type
properties	isRef 0 minOcc 1 maxOcc 2 content complex
children	m730:Stato m730:Credito
source	<pre><xs:element name="CreditoStato" type="m730:Credito_Stato_Type" maxOccurs="2"/></pre>

complexType Crediti_Imposta

diagram	
namespace	urn:www.agenziaentrate.gov.it:specificheTecniche:sco:730:v1
children	m730:Primo_Modulo m730:Modulo
used by	element Dati_Contabili_Type/QuadroG
annotation	documentation Quadro G - Crediti d'Imposta
source	<pre><xs:complexType name="Crediti_Imposta"> <xs:annotation> <xs:documentation>Quadro G - Crediti d'Imposta</xs:documentation> </xs:annotation> <xs:sequence> <xs:element name="Primo_Modulo" type="m730:Primo_Modulo_Crediti_Imposta_Type"/> <xs:element name="Modulo" type="m730:Modulo_Crediti_Imposta_Type" minOccurs="0" maxOccurs="unbounded"/> </xs:sequence> </xs:complexType></pre>

element **Crediti_Imposta/Primo_Modulo**

diagram	
namespace	urn:www.agenziaentrate.gov.it:specificheTecniche:sco:730:v1
type	m730:Primo_Modulo_Crediti_Imposta_Type
properties	isRef 0 content complex
children	m730:CreditoImpostaFabbicati m730:CreditoImpostaFondiPensione m730:CreditoImpostaRedditiEsteri m730:CreditoPrimaCasaSismaAbruzzo m730:CreditoAltriSismaAbruzzo m730:CreditoIncrementoOccupazione m730:CreditoImpostaMediazioni
source	<pre><xs:element name="Primo_Modulo" type="m730:Primo_Modulo_Crediti_Imposta_Type"/></pre>

element **Crediti_Imposta/Modulo**

diagram	
namespace	urn:www.agenziaentrate.gov.it:specificheTecniche:sco:730:v1
type	m730:Modulo_Crediti_Imposta_Type
properties	isRef 0 minOcc 0 maxOcc unbounded content complex
children	m730:CreditoImpostaFondiPensione m730:CreditoImpostaRedditiEsteri m730:CreditoPrimaCasaSismaAbruzzo m730:CreditoAltriSismaAbruzzo

source	<pre><xs:element name="Modulo" type="m730:Modulo_Crediti_Imposta_Type" minOccurs="0" maxOccurs="unbounded"/></pre>
--------	--

complexType **Crediti_Imposta_Altri_Sisma_Abruzzo_Type**

diagram	
namespace	urn:www.agenziaentrate.gov.it:specificheTecniche:sco:730:v1
children	m730:Impresa_Professione m730:CreditoImmobileSismaAbruzzo m730:Rateazione
used by	elements Primo_Modulo_Crediti_Imposta_Type/CreditoAltriSismaAbruzzo Modulo_Crediti_Imposta_Type/CreditoAltriSismaAbruzzo
source	<pre><xs:complexType name="Crediti_Imposta_Altri_Sisma_Abruzzo_Type"> <xs:sequence> <xs:element name="Impresa_Professione" type="cm:DatoCB_Type" minOccurs="0"/> <xs:element name="CreditoImmobileSismaAbruzzo" type="m730:Credito_Immobile_Sisma_Abruzzo_Type" minOccurs="0"/> <xs:element name="Rateazione" type="m730:Numero_Rate5o10_Type" minOccurs="0"/> </xs:sequence> </xs:complexType></pre>

element **Crediti_Imposta_Altri_Sisma_Abruzzo_Type/Impresa_Professione**

diagram	
namespace	urn:www.agenziaentrate.gov.it:specificheTecniche:sco:730:v1
type	DatoCB_Type
properties	isRef 0 minOcc 0 maxOcc 1 content simple
facets	Kind Value annotation pattern [01]
source	<pre><xs:element name="Impresa_Professione" type="cm:DatoCB_Type" minOccurs="0"/></pre>

element **Crediti Imposta Altri Sisma Abruzzo Type/CreditoImmobilSismaAbruzzo**

diagram									
namespace	urn:www.agenziaentrate.gov.it:specificheTecniche:sco:730:v1								
type	m730:Credito_ImmobilSismaAbruzzo_Type								
properties	<table border="0"> <tr><td>isRef</td><td>0</td></tr> <tr><td>minOcc</td><td>0</td></tr> <tr><td>maxOcc</td><td>1</td></tr> <tr><td>content</td><td>complex</td></tr> </table>	isRef	0	minOcc	0	maxOcc	1	content	complex
isRef	0								
minOcc	0								
maxOcc	1								
content	complex								
children	m730:CodiceFiscale m730:NumeroRata m730:TotaleCredito								
source	<pre><xs:element name="CreditoImmobilSismaAbruzzo" type="m730:Credito_ImmobilSismaAbruzzo_Type" minOccurs="0"/></pre>								

element **Crediti Imposta Altri Sisma Abruzzo Type/Rateazione**

diagram																
namespace	urn:www.agenziaentrate.gov.it:specificheTecniche:sco:730:v1															
type	m730:Numero_Rate5o10_Type															
properties	<table border="0"> <tr><td>isRef</td><td>0</td></tr> <tr><td>minOcc</td><td>0</td></tr> <tr><td>maxOcc</td><td>1</td></tr> <tr><td>content</td><td>simple</td></tr> </table>	isRef	0	minOcc	0	maxOcc	1	content	simple							
isRef	0															
minOcc	0															
maxOcc	1															
content	simple															
facets	<table border="0"> <tr><td>Kind</td><td>Value</td><td>annotation</td></tr> <tr><td>maxLength</td><td>2</td><td></td></tr> <tr><td>pattern</td><td>[1-9]{1}[0-9]*</td><td></td></tr> <tr><td>enumeration</td><td>5</td><td></td></tr> <tr><td>enumeration</td><td>10</td><td></td></tr> </table>	Kind	Value	annotation	maxLength	2		pattern	[1-9]{1}[0-9]*		enumeration	5		enumeration	10	
Kind	Value	annotation														
maxLength	2															
pattern	[1-9]{1}[0-9]*															
enumeration	5															
enumeration	10															
source	<pre><xs:element name="Rateazione" type="m730:Numero_Rate5o10_Type" minOccurs="0"/></pre>															

complexType **Crediti Imposta Fabbicati Type**

diagram	
namespace	urn:www.agenziaentrate.gov.it:specificheTecniche:sco:730:v1
children	m730:ResiduoFabbicati m730:CanoniLocazioneNonPercepti

used by	element Primo Modulo Crediti Imposta Type/CreditImpostaFabbicati
source	<pre><xs:complexType name="Crediti_Imposta_Fabbicati_Type"> <xs:sequence> <xs:element name="ResiduoFabbicati" type="m730:Residuo_Credito_Compens_AnnoImposta_Type" minOccurs="0"/> <xs:element name="CanoniLocazioneNonPercepiti" type="cm:DatoNP_Type" minOccurs="0"/> </xs:sequence> </xs:complexType></pre>

element [Crediti_Imposta_Fabbicati_Type/ResiduoFabbicati](#)

diagram	
namespace	urn:www.agenziaentrate.gov.it:specificheTecniche:sco:730:v1
type	m730:Residuo_Credito_Compens_AnnoImposta_Type
properties	isRef 0 minOcc 0 maxOcc 1 content complex
children	m730:ResiduoPrecedenteDichiarazione m730:CreditoAnno m730:DiCuiCompensatoF24
source	<pre><xs:element name="ResiduoFabbicati" type="m730:Residuo_Credito_Compens_AnnoImposta_Type" minOccurs="0"/></pre>

element [Crediti_Imposta_Fabbicati_Type/CanoniLocazioneNonPercepiti](#)

diagram	
namespace	urn:www.agenziaentrate.gov.it:specificheTecniche:sco:730:v1
type	DatoNP_Type
properties	isRef 0 minOcc 0 maxOcc 1 content simple
facets	Kind Value annotation pattern [1-9]{1}[0-9]*
source	<pre><xs:element name="CanoniLocazioneNonPercepiti" type="cm:DatoNP_Type" minOccurs="0"/></pre>

complexType **Crediti_Imposta_Fondi_Pensione_Type**

diagram	
namespace	urn:www.agenziaentrate.gov.it:specificheTecniche:sco:730:v1
children	m730:AnnoAnticipazione m730:Reintegro m730:SommaReintegrata m730:CreditoAnno
used by	elements Primo Modulo Crediti Imposta Type/CreditiImpostaFondiPensione Modulo Crediti Imposta Type/CreditiImpostaFondiPensione
source	<pre><xs:complexType name="Crediti_Imposta_Fondi_Pensione_Type"> <xs:sequence> <xs:element name="AnnoAnticipazione" type="m730:Anno_Anticipazione_Fondo_Pensione_Type" minOccurs="0"/> <xs:element name="Reintegro" type="m730:Reintegro_Totale_Parziale_Type" minOccurs="0"/> <xs:element name="SommaReintegrata" type="cm:DatoNP_Type" minOccurs="0"/> <xs:element name="CreditoAnno" type="cm:DatoNP_Type" minOccurs="0"/> </xs:sequence> </xs:complexType></pre>

element **Crediti_Imposta_Fondi_Pensione_Type/AnnoAnticipazione**

diagram																						
namespace	urn:www.agenziaentrate.gov.it:specificheTecniche:sco:730:v1																					
type	m730:Anno_Anticipazione_Fondo_Pensione_Type																					
properties	<table border="0"> <tr><td>isRef</td><td>0</td></tr> <tr><td>minOcc</td><td>0</td></tr> <tr><td>maxOcc</td><td>1</td></tr> <tr><td>content</td><td>simple</td></tr> </table>	isRef	0	minOcc	0	maxOcc	1	content	simple													
isRef	0																					
minOcc	0																					
maxOcc	1																					
content	simple																					
facets	<table border="0"> <tr><td>Kind</td><td>Value</td><td>annotation</td></tr> <tr><td>length</td><td>4</td><td></td></tr> <tr><td>pattern</td><td>[1-9]{1}[0-9]*</td><td></td></tr> <tr><td>enumeration</td><td>2008</td><td></td></tr> <tr><td>enumeration</td><td>2009</td><td></td></tr> <tr><td>enumeration</td><td>2010</td><td></td></tr> <tr><td>enumeration</td><td>2011</td><td></td></tr> </table>	Kind	Value	annotation	length	4		pattern	[1-9]{1}[0-9]*		enumeration	2008		enumeration	2009		enumeration	2010		enumeration	2011	
Kind	Value	annotation																				
length	4																					
pattern	[1-9]{1}[0-9]*																					
enumeration	2008																					
enumeration	2009																					
enumeration	2010																					
enumeration	2011																					
source	<pre><xs:element name="AnnoAnticipazione"</pre>																					

	<code>type="m730:Anno_Anticipazione_Fondo_Pensione_Type" minOccurs="0"/></code>
--	--

element **Crediti Imposta Fondi Pensione_Type/Reintegro**

diagram	
namespace	urn:www.agenziaentrate.gov.it:specificheTecniche:sco:730:v1
type	m730:Reintegro_Totale_Parziale_Type
properties	isRef 0 minOcc 0 maxOcc 1 content simple
facets	Kind Value annotation maxLength 1 pattern [1-9] enumeration 1 enumeration 2
source	<code><xs:element name="Reintegro" type="m730:Reintegro_Totale_Parziale_Type" minOccurs="0"/></code>

element **Crediti Imposta Fondi Pensione_Type/SommaReintegrata**

diagram	
namespace	urn:www.agenziaentrate.gov.it:specificheTecniche:sco:730:v1
type	DatoNP_Type
properties	isRef 0 minOcc 0 maxOcc 1 content simple
facets	Kind Value annotation pattern [1-9]{1}[0-9]*
source	<code><xs:element name="SommaReintegrata" type="cm:DatoNP_Type" minOccurs="0"/></code>

element **Crediti Imposta Fondi Pensione_Type/CreditoAnno**

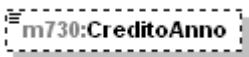
diagram	
namespace	urn:www.agenziaentrate.gov.it:specificheTecniche:sco:730:v1
type	DatoNP_Type
properties	isRef 0 minOcc 0 maxOcc 1 content simple
facets	Kind Value annotation

	pattern [1-9]{1}[0-9]*
source	<code><xs:element name="CreditoAnno" type="cm:DatoNP_Type" minOccurs="0"/></code>

complexType **Crediti_Imposta_Reddito_Esteri_Type**

diagram	
namespace	urn:www.agenziaentrate.gov.it:specificheTecniche:sco:730:v1
children	m730:StatoEstero m730:Anno m730:RedditoEstero m730:ImpostaEstera m730:RedditoComplessivo m730:Imposta_Lorda m730:ImpostaNetta m730:CreditoDichiarazioniPrecedenti m730:DiCuiStatoEstero
used by	elements Primo Modulo Crediti Imposta Type/CreditiImpostaRedditiEsteri Modulo Crediti Imposta Type/CreditiImpostaRedditiEsteri
source	<pre> <xs:complexType name="Crediti_Imposta_Reddito_Esteri_Type"> <xs:sequence> <xs:element name="StatoEstero"> <xs:simpleType> <xs:restriction base="cm:DatoNP_Type"> <xs:length value="3"/> </xs:restriction> </xs:simpleType> </xs:element> <xs:element name="Anno"> <xs:simpleType> <xs:restriction base="cm:DatoNP_Type"> <xs:length value="4"/> </xs:restriction> </xs:simpleType> </xs:element> <xs:element name="RedditoEstero" type="cm:DatoNP_Type"/> <xs:element name="ImpostaEstera" type="cm:DatoNP_Type" minOccurs="0"/> </pre>

	<pre> <xs:element name="RedditoComplessivo" type="cm:DatoNP_Type" minOccurs="0"/> <xs:element name="Imposta_Lorda" type="cm:DatoNP_Type" minOccurs="0"/> <xs:element name="ImpostaNetta" type="cm:DatoNP_Type" minOccurs="0"/> <xs:element name="CreditoDichiarazioniPrecedenti" type="cm:DatoNP_Type" minOccurs="0"/> <xs:element name="DiCuiStatoEestero" type="cm:DatoNP_Type" minOccurs="0"/> </xs:sequence> </xs:complexType> </pre>
--	---

element **Crediti_Imposta_Reddi_Esteri_Type/StatoEestero**

diagram	
namespace	urn:www.agenziaentrate.gov.it:specificheTecniche:sco:730:v1
type	restriction of DatoNP_Type
properties	isRef 0 content simple
facets	Kind Value annotation length 3 pattern [1-9]{1}[0-9]*
source	<pre> <xs:element name="StatoEestero"> <xs:simpleType> <xs:restriction base="cm:DatoNP_Type"> <xs:length value="3"/> </xs:restriction> </xs:simpleType> </xs:element> </pre>

element **Crediti_Imposta_Reddi_Esteri_Type/Anno**

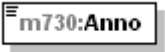
diagram	
namespace	urn:www.agenziaentrate.gov.it:specificheTecniche:sco:730:v1
type	restriction of DatoNP_Type
properties	isRef 0 content simple
facets	Kind Value annotation length 4 pattern [1-9]{1}[0-9]*
source	<pre> <xs:element name="Anno"> <xs:simpleType> <xs:restriction base="cm:DatoNP_Type"> </pre>

	<pre> <xs:length value="4"/> </xs:restriction> </xs:simpleType> </xs:element> </pre>
--	--

element Crediti_Imposta_Redditi_Esteri_Type/RedditoEstero

diagram	
namespace	urn:www.agenziaentrate.gov.it:specificheTecniche:sco:730:v1
type	DatoNP_Type
properties	isRef 0 content simple
facets	Kind Value annotation pattern [1-9]{1}[0-9]*
source	<pre><xs:element name="RedditoEstero" type="cm:DatoNP_Type"/></pre>

element Crediti_Imposta_Redditi_Esteri_Type/ImpostaEstera

diagram	
namespace	urn:www.agenziaentrate.gov.it:specificheTecniche:sco:730:v1
type	DatoNP_Type
properties	isRef 0 minOcc 0 maxOcc 1 content simple
facets	Kind Value annotation pattern [1-9]{1}[0-9]*
source	<pre><xs:element name="ImpostaEstera" type="cm:DatoNP_Type" minOccurs="0"/></pre>

element Crediti_Imposta_Redditi_Esteri_Type/RedditoComplessivo

diagram	
namespace	urn:www.agenziaentrate.gov.it:specificheTecniche:sco:730:v1
type	DatoNP_Type
properties	isRef 0 minOcc 0 maxOcc 1 content simple
facets	Kind Value annotation pattern [1-9]{1}[0-9]*
source	<pre><xs:element name="RedditoComplessivo" type="cm:DatoNP_Type" minOccurs="0"/></pre>

element **Crediti_Imposta_Reddito_Esteri_Type/Imposta_Lorda**

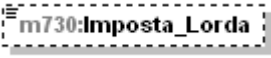
diagram	
namespace	urn:www.agenziaentrate.gov.it:specificheTecniche:sco:730:v1
type	DatoNP_Type
properties	isRef 0 minOcc 0 maxOcc 1 content simple
facets	Kind Value annotation pattern [1-9]{1}[0-9]*
source	<pre><xs:element name="Imposta_Lorda" type="cm:DatoNP_Type" minOccurs="0"/></pre>

element **Crediti_Imposta_Reddito_Esteri_Type/ImpostaNetta**

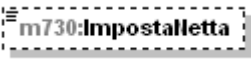
diagram	
namespace	urn:www.agenziaentrate.gov.it:specificheTecniche:sco:730:v1
type	DatoNP_Type
properties	isRef 0 minOcc 0 maxOcc 1 content simple
facets	Kind Value annotation pattern [1-9]{1}[0-9]*
source	<pre><xs:element name="ImpostaNetta" type="cm:DatoNP_Type" minOccurs="0"/></pre>

element **Crediti_Imposta_Reddito_Esteri_Type/CreditoDichiarazioniPrecedenti**

diagram	
namespace	urn:www.agenziaentrate.gov.it:specificheTecniche:sco:730:v1
type	DatoNP_Type
properties	isRef 0 minOcc 0 maxOcc 1 content simple
facets	Kind Value annotation pattern [1-9]{1}[0-9]*
source	<pre><xs:element name="CreditoDichiarazioniPrecedenti" type="cm:DatoNP_Type" minOccurs="0"/></pre>

element **Crediti Imposta Redditi Esteri Type/DiCuiStatoEstero**

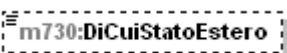
diagram	
namespace	urn:www.agenziaentrate.gov.it:specificheTecniche:sco:730:v1
type	DatoNP_Type
properties	isRef 0 minOcc 0 maxOcc 1 content simple
facets	Kind Value annotation pattern [1-9]{1}[0-9]*
source	<pre><xs:element name="DiCuiStatoEstero" type="cm:DatoNP_Type" minOccurs="0"/></pre>

complexType **Credito Immobile Sisma Abruzzo Type**

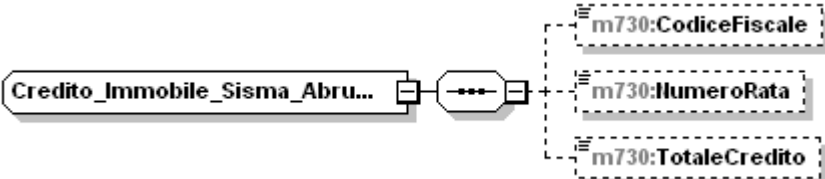
diagram	
namespace	urn:www.agenziaentrate.gov.it:specificheTecniche:sco:730:v1
children	m730:CodiceFiscale m730:NumeroRata m730:TotaleCredito
used by	elements Crediti Imposta Altri Sisma Abruzzo Type/CreditoImmobileSismaAbruzzo Primo Modulo Crediti Imposta Type/CreditoPrimaCasaSismaAbruzzo Modulo Crediti Imposta Type/CreditoPrimaCasaSismaAbruzzo
source	<pre><xs:complexType name="Credito_Immobile_Sisma_Abruzzo_Type"> <xs:sequence> <xs:element name="CodiceFiscale" type="cm:DatoCF_Type" minOccurs="0"/> <xs:element name="NumeroRata" type="m730:Numero_RateDalA3_Type" minOccurs="0"/> <xs:element name="TotaleCredito" type="cm:DatoNP_Type" minOccurs="0"/> </xs:sequence> </xs:complexType></pre>

element **Credito Immobile Sisma Abruzzo Type/CodiceFiscale**

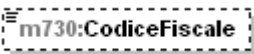
diagram	
namespace	urn:www.agenziaentrate.gov.it:specificheTecniche:sco:730:v1
type	DatoCF_Type
properties	isRef 0 minOcc 0 maxOcc 1

	content simple							
facets	<table border="1"> <tr> <td>Kind</td> <td>Value</td> <td>annotation</td> </tr> <tr> <td>pattern</td> <td>[0-9]{11}[[A-Z]{6}[0-9LMNPQRSTUUV]{2}[A-Z]{1}[0-9LMNPQRSTUUV]{2}[A-Z]{1}[0-9LMNPQRSTUUV]{3}[A-Z]{1}</td> <td></td> </tr> </table>	Kind	Value	annotation	pattern	[0-9]{11}[[A-Z]{6}[0-9LMNPQRSTUUV]{2}[A-Z]{1}[0-9LMNPQRSTUUV]{2}[A-Z]{1}[0-9LMNPQRSTUUV]{3}[A-Z]{1}		
Kind	Value	annotation						
pattern	[0-9]{11}[[A-Z]{6}[0-9LMNPQRSTUUV]{2}[A-Z]{1}[0-9LMNPQRSTUUV]{2}[A-Z]{1}[0-9LMNPQRSTUUV]{3}[A-Z]{1}							
source	<pre><xs:element name="CodiceFiscale" type="cm:DatoCF_Type" minOccurs="0"/></pre>							

element Credito_Immobile_Sisma_Abruzzo_Type/NumeroRata

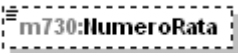
diagram																				
namespace	urn:www.agenziaentrate.gov.it:specificheTecniche:sco:730:v1																			
type	m730:Numero_RateDa1A3_Type																			
properties	<table border="1"> <tr> <td>isRef</td> <td>0</td> </tr> <tr> <td>minOcc</td> <td>0</td> </tr> <tr> <td>maxOcc</td> <td>1</td> </tr> <tr> <td>content</td> <td>simple</td> </tr> </table>		isRef	0	minOcc	0	maxOcc	1	content	simple										
isRef	0																			
minOcc	0																			
maxOcc	1																			
content	simple																			
facets	<table border="1"> <tr> <td>Kind</td> <td>Value</td> <td>annotation</td> </tr> <tr> <td>maxLength</td> <td>1</td> <td></td> </tr> <tr> <td>pattern</td> <td>[1-9]</td> <td></td> </tr> <tr> <td>enumeration</td> <td>1</td> <td></td> </tr> <tr> <td>enumeration</td> <td>2</td> <td></td> </tr> <tr> <td>enumeration</td> <td>3</td> <td></td> </tr> </table>		Kind	Value	annotation	maxLength	1		pattern	[1-9]		enumeration	1		enumeration	2		enumeration	3	
Kind	Value	annotation																		
maxLength	1																			
pattern	[1-9]																			
enumeration	1																			
enumeration	2																			
enumeration	3																			
source	<pre><xs:element name="NumeroRata" type="m730:Numero_RateDa1A3_Type" minOccurs="0"/></pre>																			

element Credito_Immobile_Sisma_Abruzzo_Type/TotaleCredito

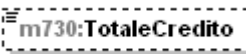
diagram										
namespace	urn:www.agenziaentrate.gov.it:specificheTecniche:sco:730:v1									
type	DatoNP_Type									
properties	<table border="1"> <tr> <td>isRef</td> <td>0</td> </tr> <tr> <td>minOcc</td> <td>0</td> </tr> <tr> <td>maxOcc</td> <td>1</td> </tr> <tr> <td>content</td> <td>simple</td> </tr> </table>		isRef	0	minOcc	0	maxOcc	1	content	simple
isRef	0									
minOcc	0									
maxOcc	1									
content	simple									
facets	<table border="1"> <tr> <td>Kind</td> <td>Value</td> <td>annotation</td> </tr> <tr> <td>pattern</td> <td>[1-9]{1}[0-9]*</td> <td></td> </tr> </table>		Kind	Value	annotation	pattern	[1-9]{1}[0-9]*			
Kind	Value	annotation								
pattern	[1-9]{1}[0-9]*									
source	<pre><xs:element name="TotaleCredito" type="cm:DatoNP_Type" minOccurs="0"/></pre>									

complexType Credito_Stato_Type

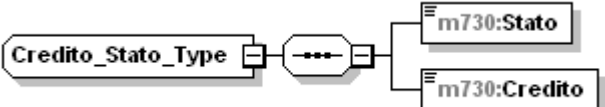
diagram		
---------	---	--

namespace	urn:www.agenziaentrate.gov.it:specificheTecniche:sco:730:v1
children	m730:Stato m730:Credito
used by	element Cred Imp Estero Type/CreditoStato
source	<pre><xs:complexType name="Credito_Stato_Type"> <xs:sequence> <xs:element name="Stato" type="cm:DatoNP_Type"/> <xs:element name="Credito" type="cm:DatoNP_Type"/> </xs:sequence> </xs:complexType></pre>

element [Credito_Stato_Type/Stato](#)

diagram	
namespace	urn:www.agenziaentrate.gov.it:specificheTecniche:sco:730:v1
type	DatoNP_Type
properties	isRef 0 content simple
facets	Kind Value annotation pattern [1-9]{1}[0-9]*
source	<pre><xs:element name="Stato" type="cm:DatoNP_Type"/></pre>

element [Credito_Stato_Type/Credito](#)

diagram	
namespace	urn:www.agenziaentrate.gov.it:specificheTecniche:sco:730:v1
type	DatoNP_Type
properties	isRef 0 content simple
facets	Kind Value annotation pattern [1-9]{1}[0-9]*
source	<pre><xs:element name="Credito" type="cm:DatoNP_Type"/></pre>

complexType [Credito_Type](#)

diagram	
---------	--

namespace	urn:www.agenziaentrate.gov.it:specificheTecniche:sco:730:v1
children	m730:NonRimborsabile m730:Credito m730:CreditoF24 m730:CreditoRimborso
used by	element Esito Liquidazione Type/Credito
source	<pre><xs:complexType name="Credito_Type"> <xs:sequence> <xs:element name="NonRimborsabile" type="cm:DatoNP_Type" minOccurs="0"/> <xs:element name="Credito" type="cm:DatoNP_Type" minOccurs="0"/> <xs:element name="CreditoF24" type="cm:DatoNP_Type" minOccurs="0"/> <xs:element name="CreditoRimborso" type="cm:DatoNP_Type" minOccurs="0"/> </xs:sequence> </xs:complexType></pre>

element **Credito_Type/NonRimborsabile**

diagram									
namespace	urn:www.agenziaentrate.gov.it:specificheTecniche:sco:730:v1								
type	DatoNP_Type								
properties	<table border="0"> <tr><td>isRef</td><td>0</td></tr> <tr><td>minOcc</td><td>0</td></tr> <tr><td>maxOcc</td><td>1</td></tr> <tr><td>content</td><td>simple</td></tr> </table>	isRef	0	minOcc	0	maxOcc	1	content	simple
isRef	0								
minOcc	0								
maxOcc	1								
content	simple								
facets	<table border="0"> <tr><td>Kind</td><td>Value</td><td>annotation</td></tr> <tr><td>pattern</td><td>[1-9]{1}[0-9]*</td><td></td></tr> </table>	Kind	Value	annotation	pattern	[1-9]{1}[0-9]*			
Kind	Value	annotation							
pattern	[1-9]{1}[0-9]*								
source	<pre><xs:element name="NonRimborsabile" type="cm:DatoNP_Type" minOccurs="0"/></pre>								

element **Credito_Type/Credito**

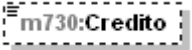
diagram									
namespace	urn:www.agenziaentrate.gov.it:specificheTecniche:sco:730:v1								
type	DatoNP_Type								
properties	<table border="0"> <tr><td>isRef</td><td>0</td></tr> <tr><td>minOcc</td><td>0</td></tr> <tr><td>maxOcc</td><td>1</td></tr> <tr><td>content</td><td>simple</td></tr> </table>	isRef	0	minOcc	0	maxOcc	1	content	simple
isRef	0								
minOcc	0								
maxOcc	1								
content	simple								
facets	<table border="0"> <tr><td>Kind</td><td>Value</td><td>annotation</td></tr> <tr><td>pattern</td><td>[1-9]{1}[0-9]*</td><td></td></tr> </table>	Kind	Value	annotation	pattern	[1-9]{1}[0-9]*			
Kind	Value	annotation							
pattern	[1-9]{1}[0-9]*								
source	<pre><xs:element name="Credito" type="cm:DatoNP_Type" minOccurs="0"/></pre>								

element Credito_Type/CreditoF24

diagram	
namespace	urn:www.agenziaentrate.gov.it:specificheTecniche:sco:730:v1
type	DatoNP_Type
properties	isRef 0 minOcc 0 maxOcc 1 content simple
facets	Kind Value annotation pattern [1-9]{1}[0-9]*
source	<pre><xs:element name="CreditoF24" type="cm:DatoNP_Type" minOccurs="0"/></pre>

element Credito_Type/CreditoRimborso

diagram	
namespace	urn:www.agenziaentrate.gov.it:specificheTecniche:sco:730:v1
type	DatoNP_Type
properties	isRef 0 minOcc 0 maxOcc 1 content simple
facets	Kind Value annotation pattern [1-9]{1}[0-9]*
source	<pre><xs:element name="CreditoRimborso" type="cm:DatoNP_Type" minOccurs="0"/></pre>

complexType Dati_730Integrativo_Type

diagram	
namespace	urn:www.agenziaentrate.gov.it:specificheTecniche:sco:730:v1
children	m730:Rimborso m730:Credito
used by	element Primo Modulo Acconti Ritenute Type/Dati730Integrativo
source	<pre><xs:complexType name="Dati_730Integrativo_Type"> <xs:sequence> <xs:element name="Rimborso" type="m730:Elemento_Integrativo_Type" minOccurs="0"/> <xs:element name="Credito" type="m730:Elemento_Integrativo_Type" minOccurs="0"/> </xs:sequence> </complexType></pre>

```
</xs:complexType>
```

element Dati_730Integrativo_Type/Rimborso

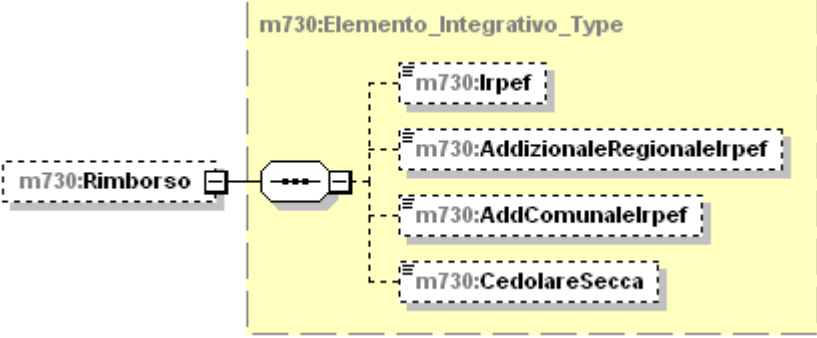
diagram	
namespace	urn:www.agenziaentrate.gov.it:specificheTecniche:sco:730:v1
type	m730:Elemento_Integrativo_Type
properties	isRef 0 minOcc 0 maxOcc 1 content complex
children	m730:lrpef m730:AddizionaleRegionalelrpef m730:AddComunalelrpef m730:CedolareSecca
source	<pre><xs:element name="Rimborso" type="m730:Elemento_Integrativo_Type" minOccurs="0"/></pre>

element Dati_730Integrativo_Type/Credito

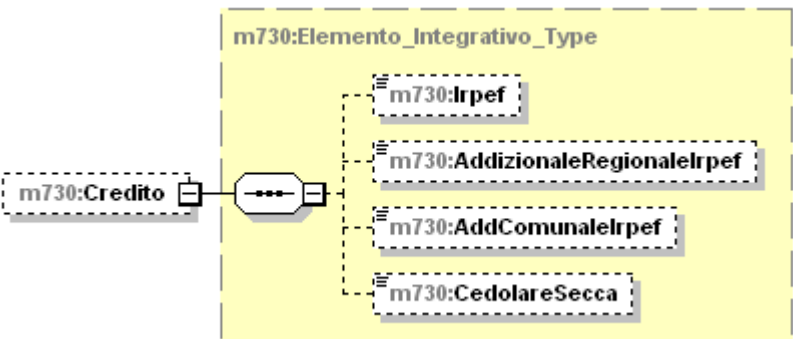
diagram	
namespace	urn:www.agenziaentrate.gov.it:specificheTecniche:sco:730:v1
type	m730:Elemento_Integrativo_Type
properties	isRef 0 minOcc 0 maxOcc 1 content complex
children	m730:lrpef m730:AddizionaleRegionalelrpef m730:AddComunalelrpef m730:CedolareSecca
source	<pre><xs:element name="Credito" type="m730:Elemento_Integrativo_Type" minOccurs="0"/></pre>

complexType Dati_Altre_Detrazioni_Modulo_Type

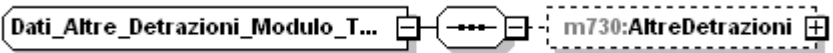
diagram	
namespace	urn:www.agenziaentrate.gov.it:specificheTecniche:sco:730:v1
children	m730:AltreDetrazioni
used by	element Modulo_Oneri_Type/DatiAltreDetrazioni
source	<pre><xs:complexType name="Dati_Altre_Detrazioni_Modulo_Type"> <xs:sequence> <xs:element name="AltreDetrazioni" type="m730:Altre_Detrazioni_Type" minOccurs="0"/> </xs:sequence> </xs:complexType></pre>

element Dati_Altre_Detrazioni_Modulo_Type/AltreDetrazioni

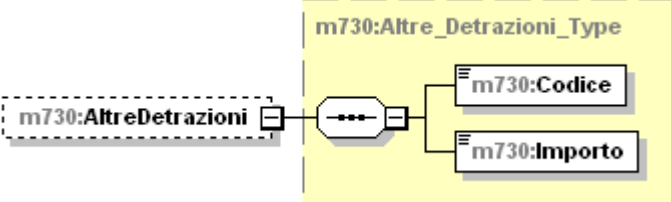
diagram	
namespace	urn:www.agenziaentrate.gov.it:specificheTecniche:sco:730:v1
type	m730:Altre_Detrazioni_Type
properties	isRef 0 minOcc 0 maxOcc 1 content complex
children	m730:Codice m730:Importo
source	<pre><xs:element name="AltreDetrazioni" type="m730:Altre_Detrazioni_Type" minOccurs="0"/></pre>

complexType Dati_Altre_Detrazioni_Type

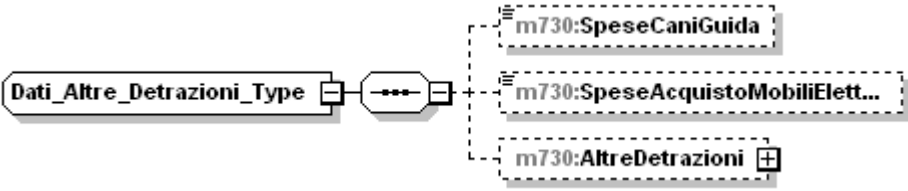
diagram	
namespace	urn:www.agenziaentrate.gov.it:specificheTecniche:sco:730:v1
children	m730:SpeseCaniGuida m730:SpeseAcquistoMobiliElett...TVPC m730:AltreDetrazioni
used by	element PrimoModulo_Oneri_Type/DatiAltreDetrazioni

source	<pre> <xs:complexType name="Dati_Altre_Detrazioni_Type"> <xs:sequence> <xs:element name="SpeseCaniGuida" type="cm:DatoCB_Type" minOccurs="0"/> <xs:element name="SpeseAcquistoMobiliElettTVPC" type="cm:DatoNP_Type" minOccurs="0"/> <xs:element name="AltreDetrazioni" type="m730:Altre_Detrazioni_Type" minOccurs="0"/> </xs:sequence> </xs:complexType> </pre>
--------	---

element Dati_Altre_Detrazioni_Type/SpeseCaniGuida

diagram									
namespace	urn:www.agenziaentrate.gov.it:specificheTecniche:sco:730:v1								
type	DatoCB_Type								
properties	<table border="0"> <tr><td>isRef</td><td>0</td></tr> <tr><td>minOcc</td><td>0</td></tr> <tr><td>maxOcc</td><td>1</td></tr> <tr><td>content</td><td>simple</td></tr> </table>	isRef	0	minOcc	0	maxOcc	1	content	simple
isRef	0								
minOcc	0								
maxOcc	1								
content	simple								
facets	<table border="0"> <tr><td>Kind</td><td>Value</td><td>annotation</td></tr> <tr><td>pattern</td><td>[01]</td><td></td></tr> </table>	Kind	Value	annotation	pattern	[01]			
Kind	Value	annotation							
pattern	[01]								
source	<pre> <xs:element name="SpeseCaniGuida" type="cm:DatoCB_Type" minOccurs="0"/> </pre>								

element Dati_Altre_Detrazioni_Type/SpeseAcquistoMobiliElettTVPC

diagram									
namespace	urn:www.agenziaentrate.gov.it:specificheTecniche:sco:730:v1								
type	DatoNP_Type								
properties	<table border="0"> <tr><td>isRef</td><td>0</td></tr> <tr><td>minOcc</td><td>0</td></tr> <tr><td>maxOcc</td><td>1</td></tr> <tr><td>content</td><td>simple</td></tr> </table>	isRef	0	minOcc	0	maxOcc	1	content	simple
isRef	0								
minOcc	0								
maxOcc	1								
content	simple								
facets	<table border="0"> <tr><td>Kind</td><td>Value</td><td>annotation</td></tr> <tr><td>pattern</td><td>[1-9]{1}[0-9]*</td><td></td></tr> </table>	Kind	Value	annotation	pattern	[1-9]{1}[0-9]*			
Kind	Value	annotation							
pattern	[1-9]{1}[0-9]*								
source	<pre> <xs:element name="SpeseAcquistoMobiliElettTVPC" type="cm:DatoNP_Type" minOccurs="0"/> </pre>								

element **Dati_Altre_Detrazioni_Type/AltreDetrazioni**

diagram	
namespace	urn:www.agenziaentrate.gov.it:specificheTecniche:sco:730:v1
type	m730:Altre_Detrazioni_Type
properties	isRef 0 minOcc 0 maxOcc 1 content complex
children	m730:Codice m730:Importo
source	<pre><xs:element name="AltreDetrazioni" type="m730:Altre_Detrazioni_Type" minOccurs="0"/></pre>

complexType **Dati_Associazioni_Professionale_Type**

diagram	
namespace	urn:www.agenziaentrate.gov.it:specificheTecniche:sco:730:v1
children	m730:CFAssociazione m730:DenominazioneAssociazione m730:CFProfessionista m730:CognomeProfessionista m730:NomeProfessionista
used by	elements Documento_730-4/SoggettoAssFiscale730-4/DatiAssociazione730-4 Soggetto_Assistenza_FiscaliDoc type/DatiAssociazioneDoc
source	<pre><xs:complexType name="Dati_Associazioni_Professionale_Type"> <xs:sequence> <xs:element name="CFAssociazione" type="cm:DatoCN_Type"/> <xs:element name="DenominazioneAssociazione" type="cm:DatoAN_Type"/> <xs:element name="CFProfessionista" type="cm:DatoCF_Type"/> <xs:element name="CognomeProfessionista" type="cm:DatoAN_Type"/> <xs:element name="NomeProfessionista" type="cm:DatoAN_Type"/> </xs:sequence></pre>

	<code></xs:complexType></code>
--	--------------------------------------

element Dati_Associazioni_Professionale_Type/CFAssociazione

diagram	
namespace	urn:www.agenziaentrate.gov.it:specificheTecniche:sco:730:v1
type	DatoCN_Type
properties	isRef 0 content simple
facets	Kind Value annotation length 11 pattern [0-9]{11}
source	<code><xs:element name="CFAssociazione" type="cm:DatoCN_Type"/></code>

element Dati_Associazioni_Professionale_Type/DenominazioneAssociazione

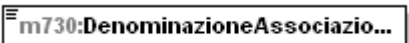
diagram	
namespace	urn:www.agenziaentrate.gov.it:specificheTecniche:sco:730:v1
type	DatoAN_Type
properties	isRef 0 content simple
facets	Kind Value annotation pattern [0-9A-Z]{1}([0-9A-Z] \- \. & . \s / \^ \)*
source	<code><xs:element name="DenominazioneAssociazione" type="cm:DatoAN_Type"/></code>

element Dati_Associazioni_Professionale_Type/CFProfessionista

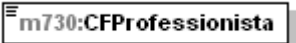
diagram	
namespace	urn:www.agenziaentrate.gov.it:specificheTecniche:sco:730:v1
type	DatoCF_Type
properties	isRef 0 content simple
facets	Kind Value annotation pattern [0-9]{11}[A-Z]{6}[0-9LMNPQRSTUUV]{2}[A-Z]{1}[0-9LMNPQRSTUUV]{2}[A-Z]{1}[0-9LMNPQRSTUUV]{3}[A-Z]{1}
source	<code><xs:element name="CFProfessionista" type="cm:DatoCF_Type"/></code>

element Dati_Associazioni_Professionale_Type/CognomeProfessionista

diagram	
---------	---

namespace	urn:www.agenziaentrate.gov.it:specificheTecniche:sco:730:v1
type	DatoAN_Type
properties	isRef 0 content simple
facets	Kind Value annotation pattern [0-9A-Z-]{1}([0-9A-Z] \\ \\. & _ \\s / ^ \\(\\))*
source	<pre><xs:element name="CognomeProfessionista" type="cm:DatoAN_Type"/></pre>

element Dati_Associazioni_Professionale_Type/NomeProfessionista

diagram	
namespace	urn:www.agenziaentrate.gov.it:specificheTecniche:sco:730:v1
type	DatoAN_Type
properties	isRef 0 content simple
facets	Kind Value annotation pattern [0-9A-Z-]{1}([0-9A-Z] \\ \\. & _ \\s / ^ \\(\\))*
source	<pre><xs:element name="NomeProfessionista" type="cm:DatoAN_Type"/></pre>

complexType Dati_CAF_Type

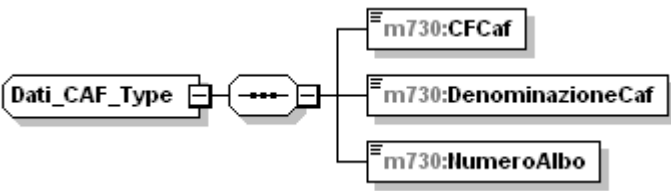
diagram	
namespace	urn:www.agenziaentrate.gov.it:specificheTecniche:sco:730:v1
children	m730:CFCaf m730:DenominazioneCaf m730:NumeroAlbo
used by	elements Documento_730-4/SoggettoAssFiscale730-4/DatiCaf730-4 Soggetto_Assistenza_FiscaliDoc_type/DatiCafDoc
source	<pre><xs:complexType name="Dati_CAF_Type"> <xs:sequence> <xs:element name="CFCaf" type="cm:DatoCN_Type"/> <xs:element name="DenominazioneCaf" type="cm:DatoAN_Type"/> <xs:element name="NumeroAlbo" type="cm:DatoN1_Type"/> </xs:sequence> </xs:complexType></pre>

element **Dati_CAF_Type/CFCaf**

diagram	
namespace	urn:www.agenziaentrate.gov.it:specificheTecniche:sco:730:v1
type	DatoCN_Type
properties	isRef 0 content simple
facets	Kind Value annotation length 11 pattern [0-9]{11}
source	<code><xs:element name="CFCaf" type="cm:DatoCN_Type"/></code>

element **Dati_CAF_Type/DenominazioneCaf**

diagram	
namespace	urn:www.agenziaentrate.gov.it:specificheTecniche:sco:730:v1
type	DatoAN_Type
properties	isRef 0 content simple
facets	Kind Value annotation pattern [0-9A-Z-]{1}([0-9A-Z] \\- \\. & _ \\s / ^ \\(\\))*
source	<code><xs:element name="DenominazioneCaf" type="cm:DatoAN_Type"/></code>

element **Dati_CAF_Type/NumeroAlbo**

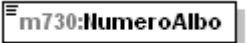
diagram	
namespace	urn:www.agenziaentrate.gov.it:specificheTecniche:sco:730:v1
type	DatoN1_Type
properties	isRef 0 content simple
facets	Kind Value annotation maxLength 1 pattern [1-9]
source	<code><xs:element name="NumeroAlbo" type="cm:DatoN1_Type"/></code>

complexType **Dati_Catastali_Recupero_Patrimonio_Edilizio_Type**

<p>diagram</p>	
<p>namespace</p>	<p>urn:www.agenziaentrate.gov.it:specificheTecniche:sco:730:v1</p>
<p>children</p>	<p>m730:NOrdImmobilabile m730:COPescaraCondominio m730:CodiceComune m730:TerreniUrbano m730:InteroPorzione m730:SezioneUrbanaComuneCatastale m730:Foglio m730:Particella m730:Subalterno</p>
<p>used by</p>	<p>element Sezione Dati Catastali Recupero Patrimonio Edilizio Type/DatiCatastaliRecuperoPatrimonioEdilizio</p>
<p>source</p>	<pre> <xs:complexType name="Dati_Catastali_Recupero_Patrimonio_Edilizio_Type"> <xs:sequence> <xs:element name="NOrdImmobilabile" type="cm:DatoNP_Type"/> <xs:choice> <xs:element name="COPescaraCondominio" type="cm:DatoCB_Type" minOccurs="0"/> <xs:sequence> <xs:element name="CodiceComune" type="cm:DatoAN_Type" minOccurs="0"/> <xs:element name="TerreniUrbano" type="m730:Terreni_Urbano_Type" minOccurs="0"/> <xs:element name="InteroPorzione" type="m730:Intero_Porzione_Type" minOccurs="0"/> <xs:element name="SezioneUrbanaComuneCatastale" type="cm:DatoAN_Type" minOccurs="0"/> <xs:element name="Foglio" type="cm:DatoAN_Type" minOccurs="0"/> <xs:element name="Particella" minOccurs="0"> <xs:complexType> <xs:sequence minOccurs="0"> <xs:element name="Numeratore" type="cm:DatoAN_Type" minOccurs="0"/> <xs:element name="Denominatore" type="cm:DatoAN_Type" minOccurs="0"/> </xs:sequence> </xs:complexType> </xs:element> </xs:sequence> </xs:choice> </xs:sequence> </xs:complexType> </pre>

	<pre> </xs:complexType> </xs:element> <xs:element name="Subalterno" type="cm:DatoAN_Type" minOccurs="0"/> </xs:sequence> </xs:choice> </xs:sequence> </xs:complexType> </pre>
--	---

element Dati_Catastali_Recupero_Patrimonio_Edilizio_Type/NOrdImmobile

diagram	
namespace	urn:www.agenziaentrate.gov.it:specificheTecniche:sco:730:v1
type	DatoNP_Type
properties	isRef 0 content simple
facets	Kind Value annotation pattern [1-9]{1}[0-9]*
source	<pre><xs:element name="NOrdImmobile" type="cm:DatoNP_Type"/></pre>

element Dati_Catastali_Recupero_Patrimonio_Edilizio_Type/COPescaraCondominio

diagram	
namespace	urn:www.agenziaentrate.gov.it:specificheTecniche:sco:730:v1
type	DatoCB_Type
properties	isRef 0 minOcc 0 maxOcc 1 content simple
facets	Kind Value annotation pattern [01]
source	<pre><xs:element name="COPescaraCondominio" type="cm:DatoCB_Type" minOccurs="0"/></pre>

element Dati_Catastali_Recupero_Patrimonio_Edilizio_Type/CodiceComune

diagram	
namespace	urn:www.agenziaentrate.gov.it:specificheTecniche:sco:730:v1
type	DatoAN_Type
properties	isRef 0 minOcc 0 maxOcc 1 content simple

facets	Kind Value annotation pattern [0-9A-Z-]{1}([0-9A-Z] \\- \\. & _ \\s / ^ \\(\\))*
source	<code><xs:element name="CodiceComune" type="cm:DatoAN_Type" minOccurs="0"/></code>

element Dati_Catastali_Recupero_Patrimonio_Edilizio_Type/TerreniUrbano

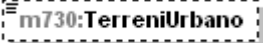
diagram	
namespace	urn:www.agenziaentrate.gov.it:specificheTecniche:sco:730:v1
type	m730:Terreni Urbano Type
properties	isRef 0 minOcc 0 maxOcc 1 content simple
facets	Kind Value annotation pattern [0-9A-Z-]{1}([0-9A-Z] \\- \\. & _ \\s / ^ \\(\\))* enumeration T enumeration U
source	<code><xs:element name="TerreniUrbano" type="m730:Terreni_Urbano_Type" minOccurs="0"/></code>

element Dati_Catastali_Recupero_Patrimonio_Edilizio_Type/InteroPorzione

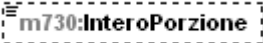
diagram	
namespace	urn:www.agenziaentrate.gov.it:specificheTecniche:sco:730:v1
type	m730:Intero Porzione Type
properties	isRef 0 minOcc 0 maxOcc 1 content simple
facets	Kind Value annotation pattern [0-9A-Z-]{1}([0-9A-Z] \\- \\. & _ \\s / ^ \\(\\))* enumeration I enumeration P
source	<code><xs:element name="InteroPorzione" type="m730:Intero_Porzione_Type" minOccurs="0"/></code>

element Dati_Catastali_Recupero_Patrimonio_Edilizio_Type/SezioneUrbanaComuneCatastale

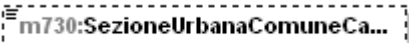
diagram	
namespace	urn:www.agenziaentrate.gov.it:specificheTecniche:sco:730:v1
type	DatoAN_Type
properties	isRef 0 minOcc 0

	maxOcc 1 content simple
facets	Kind Value annotation pattern [0-9A-Z-]{1}([0-9A-Z] \\- \\. & \\s / ° \\^ \\(\\))*
source	<code><xs:element name="SezioneUrbanaComuneCatastale" type="cm:DatoAN_Type" minOccurs="0"/></code>

element Dati_Catastali_Recupero_Patrimonio_Edilizio_Type/Foglio

diagram	
namespace	urn:www.agenziaentrate.gov.it:specificheTecniche:sco:730:v1
type	DatoAN_Type
properties	isRef 0 minOcc 0 maxOcc 1 content simple
facets	Kind Value annotation pattern [0-9A-Z-]{1}([0-9A-Z] \\- \\. & \\s / ° \\^ \\(\\))*
source	<code><xs:element name="Foglio" type="cm:DatoAN_Type" minOccurs="0"/></code>

element Dati_Catastali_Recupero_Patrimonio_Edilizio_Type/Particella

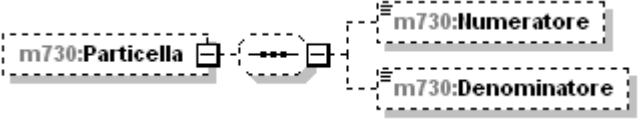
diagram	
namespace	urn:www.agenziaentrate.gov.it:specificheTecniche:sco:730:v1
properties	isRef 0 minOcc 0 maxOcc 1 content complex
children	m730:Numeratore m730:Denominatore
source	<code><xs:element name="Particella" minOccurs="0"> <xs:complexType> <xs:sequence minOccurs="0"> <xs:element name="Numeratore" type="cm:DatoAN_Type" minOccurs="0"/> <xs:element name="Denominatore" type="cm:DatoAN_Type" minOccurs="0"/> </xs:sequence> </xs:complexType> </xs:element></code>

element **Dati_Catastali_Recupero_Patrimonio_Edilizio_Type/Particella/Numeratore**

diagram	
namespace	urn:www.agenziaentrate.gov.it:specificheTecniche:sco:730:v1
type	DatoAN_Type
properties	isRef 0 minOcc 0 maxOcc 1 content simple
facets	Kind Value annotation pattern [0-9A-Z-]{1}([0-9A-Z] \\ \\. & \\s / ^ \\(\\))*
source	<pre><xs:element name="Numeratore" type="cm:DatoAN_Type" minOccurs="0"/></pre>

element **Dati_Catastali_Recupero_Patrimonio_Edilizio_Type/Particella/Denominatore**

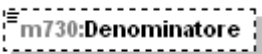
diagram	
namespace	urn:www.agenziaentrate.gov.it:specificheTecniche:sco:730:v1
type	DatoAN_Type
properties	isRef 0 minOcc 0 maxOcc 1 content simple
facets	Kind Value annotation pattern [0-9A-Z-]{1}([0-9A-Z] \\ \\. & \\s / ^ \\(\\))*
source	<pre><xs:element name="Denominatore" type="cm:DatoAN_Type" minOccurs="0"/></pre>

element **Dati_Catastali_Recupero_Patrimonio_Edilizio_Type/Subalterno**

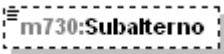
diagram	
namespace	urn:www.agenziaentrate.gov.it:specificheTecniche:sco:730:v1
type	DatoAN_Type
properties	isRef 0 minOcc 0 maxOcc 1 content simple
facets	Kind Value annotation pattern [0-9A-Z-]{1}([0-9A-Z] \\ \\. & \\s / ^ \\(\\))*
source	<pre><xs:element name="Subalterno" type="cm:DatoAN_Type" minOccurs="0"/></pre>

complexType Dati_Coniuge_Type

diagram	
namespace	urn:www.agenziaentrate.gov.it:specificheTecniche:sco:730:v1
children	m730:Tipo m730:CodiceFiscale m730:Mesi
used by	elements Familiari PrimoModulo_Type/Coniuge Modulo Familiari_Type/Coniuge
source	<pre><xs:complexType name="Dati_Coniuge_Type"> <xs:sequence> <xs:element name="Tipo" type="cm:DatoCB_Type"/> <xs:element name="CodiceFiscale" type="cm:DatoCF_Type" minOccurs="0"/> <xs:element name="Mesi" type="m730:Mesi_Type" minOccurs="0"/> </xs:sequence> </xs:complexType></pre>

element Dati_Coniuge_Type/Tipo

diagram	
namespace	urn:www.agenziaentrate.gov.it:specificheTecniche:sco:730:v1
type	DatoCB_Type
properties	isRef 0 content simple
facets	Kind Value annotation pattern [01]
source	<pre><xs:element name="Tipo" type="cm:DatoCB_Type"/></pre>

element Dati_Coniuge_Type/CodiceFiscale

diagram	
namespace	urn:www.agenziaentrate.gov.it:specificheTecniche:sco:730:v1
type	DatoCF_Type
properties	isRef 0 minOcc 0 maxOcc 1 content simple
facets	Kind Value annotation pattern [0-9]{11}[A-Z]{6}[0-9LMNPQRSTU]{2}[A-Z]{1}[0-9LMNPQRSTU]{2}[A-Z]{1}[0-9LMNPQRSTU]{3}[A-Z]{1}
source	<pre><xs:element name="CodiceFiscale" type="cm:DatoCF_Type"></pre>

	<code>minOccurs="0"/></code>
--	---------------------------------

element **Dati_Coniuge_Type/Mesi**

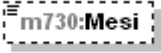
diagram	
namespace	urn:www.agenziaentrate.gov.it:specificheTecniche:sco:730:v1
type	m730:Mesi_Type
properties	isRef 0 minOcc 0 maxOcc 1 content simple
facets	Kind Value annotation pattern [1-9]{1}[0-9]* enumeration 1 enumeration 2 enumeration 3 enumeration 4 enumeration 5 enumeration 6 enumeration 7 enumeration 8 enumeration 9 enumeration 10 enumeration 11 enumeration 12
source	<code><xs:element name="Mesi" type="m730:Mesi_Type" minOccurs="0"/></code>

complexType **Dati_Contabili_Type**

<p>diagram</p>	
<p>namespace</p>	<p>urn:www.agenziaentrate.gov.it:specificheTecniche:sco:730:v1</p>
<p>children</p>	<p>m730:Familiari m730:QuadroA m730:QuadroB m730:QuadroC m730:QuadroD m730:QuadroE m730:QuadroF m730:QuadroG m730:QuadroI m730:ProspettoLiquidazione m730:Annotazioni</p>
<p>used by</p>	<p>elements Dichiarazione Dich_Type/DatiContabili Dichiarazione Con_Type/DatiContabili</p>
<p>source</p>	<pre> <xs:complexType name="Dati_Contabili_Type"> <xs:sequence> <xs:element name="Familiari" type="m730:Familiari_Type" minOccurs="0"/> <xs:element name="QuadroA" type="m730:Redditi_Terreni_Type" minOccurs="0"/> <xs:element name="QuadroB" type="m730:Redditi_Fabbricati_Type" minOccurs="0"/> <xs:element name="QuadroC" type="m730:Redditi_Lavoro_Dip_Type" minOccurs="0"/> <xs:element name="QuadroD" minOccurs="0"> <xs:complexType> <xs:complexContent> <xs:extension base="m730:Altri_Redditi_Type"/> </xs:complexContent> </xs:complexType> </xs:element> <xs:element name="QuadroE" type="m730:Oneri_Type" minOccurs="0"/> <xs:element name="QuadroF" type="m730:Acconti_Ritenute_Type" minOccurs="0"/> </pre>

	<pre> <xs:element name="QuadroG" type="m730:Crediti_Imposta" minOccurs="0"/> <xs:element name="QuadroI" type="m730:ICI_Type" minOccurs="0"/> <xs:element name="ProspettoLiquidazione" type="m730:Prospetto_Liquidazione_Type" minOccurs="0"/> <xs:element name="Annotazioni" type="m730:Annotazioni_Prospetto_Type"/> </xs:sequence> </xs:complexType> </pre>
--	---

element Dati_Contabili_Type/Familiari

diagram	
namespace	urn:www.agenziaentrate.gov.it:specificheTecniche:sco:730:v1
type	m730:Familiari_Type
properties	isRef 0 minOcc 0 maxOcc 1 content complex
children	m730:PrimoModulo m730:Modulo
source	<pre> <xs:element name="Familiari" type="m730:Familiari_Type" minOccurs="0"/> </pre>

element Dati_Contabili_Type/QuadroA

diagram	
namespace	urn:www.agenziaentrate.gov.it:specificheTecniche:sco:730:v1
type	m730:Redditi_Terreni_Type
properties	isRef 0 minOcc 0 maxOcc 1 content complex
children	m730:Modulo
source	<pre> <xs:element name="QuadroA" type="m730:Redditi_Terreni_Type" minOccurs="0"/> </pre>

element **Dati_Contabili_Type/QuadroB**

diagram	<p>The diagram shows a dashed box labeled 'm730:QuadroB' connected to a solid box labeled 'm730:Modulo'. The 'm730:Modulo' box has a multiplicity of '1..∞'. Both are contained within a larger dashed box labeled 'm730:Redditi_Fabbricati_Type'.</p>
namespace	urn:www.agenziaentrate.gov.it:specificheTecniche:sco:730:v1
type	m730:Redditi_Fabbricati_Type
properties	isRef 0 minOcc 0 maxOcc 1 content complex
children	m730:Modulo
source	<pre><xs:element name="QuadroB" type="m730:Redditi_Fabbricati_Type" minOccurs="0"/></pre>

element **Dati_Contabili_Type/QuadroC**

diagram	<p>The diagram shows a dashed box labeled 'm730:QuadroC' connected to a solid box labeled 'm730:Primo_Modulo' and a dashed box labeled 'm730:Modulo'. The 'm730:Modulo' box has a multiplicity of '0..∞'. All three are contained within a larger dashed box labeled 'm730:Redditi_Lavoro_Dip_Type'.</p>
namespace	urn:www.agenziaentrate.gov.it:specificheTecniche:sco:730:v1
type	m730:Redditi_Lavoro_Dip_Type
properties	isRef 0 minOcc 0 maxOcc 1 content complex
children	m730:Primo_Modulo m730:Modulo
source	<pre><xs:element name="QuadroC" type="m730:Redditi_Lavoro_Dip_Type" minOccurs="0"/></pre>

element **Dati_Contabili_Type/QuadroD**

diagram	<p>The diagram shows a dashed box labeled 'm730:QuadroD' connected to a solid box labeled 'm730:Modulo'. The 'm730:Modulo' box has a multiplicity of '1..∞'. Both are contained within a larger dashed box labeled 'm730:Altri_Redditi_Type (extension)'.</p>
namespace	urn:www.agenziaentrate.gov.it:specificheTecniche:sco:730:v1

type	extension of m730:Altri_Reddito_Type
properties	isRef 0 minOcc 0 maxOcc 1 content complex
children	m730:Modulo
source	<pre><xs:element name="QuadroD" minOccurs="0"> <xs:complexType> <xs:complexContent> <xs:extension base="m730:Altri_Reddito_Type"/> </xs:complexContent> </xs:complexType> </xs:element></pre>

element Dati_Contabili_Type/QuadroE

diagram	
namespace	urn:www.agenziaentrate.gov.it:specificheTecniche:sco:730:v1
type	m730:Oneri_Type
properties	isRef 0 minOcc 0 maxOcc 1 content complex
children	m730:PrimoModulo m730:Modulo
source	<pre><xs:element name="QuadroE" type="m730:Oneri_Type" minOccurs="0"/></pre>

element Dati_Contabili_Type/QuadroF

diagram	
namespace	urn:www.agenziaentrate.gov.it:specificheTecniche:sco:730:v1
type	m730:Acconti_Ritenute_Type
properties	isRef 0 minOcc 0

	maxOcc 1 content complex
children	m730:PrimoModulo m730:Modulo
source	<code><xs:element name="QuadroF" type="m730:Acconti_Ritenute_Type" minOccurs="0"/></code>

element Dati_Contabili_Type/QuadroG

diagram	
namespace	urn:www.agenziaentrate.gov.it:specificheTecniche:sco:730:v1
type	m730:Crediti_Imposta
properties	isRef 0 minOcc 0 maxOcc 1 content complex
children	m730:Primo_Modulo m730:Modulo
source	<code><xs:element name="QuadroG" type="m730:Crediti_Imposta" minOccurs="0"/></code>

element Dati_Contabili_Type/QuadroI

diagram	
namespace	urn:www.agenziaentrate.gov.it:specificheTecniche:sco:730:v1
type	m730:ICI_Type
properties	isRef 0 minOcc 0 maxOcc 1 content complex
children	m730:Casella m730:Importo
source	<code><xs:element name="QuadroI" type="m730:ICI_Type" minOccurs="0"/></code>

element **Dati_Contabili_Type/ProspettoLiquidazione**

diagram	
namespace	urn:www.agenziaentrate.gov.it:specificheTecniche:sco:730:v1
type	m730:Prospetto_Liquidazione_Type
properties	isRef 0 minOcc 0 maxOcc 1 content complex
children	m730:PrimoModulo m730:Modulo
source	<pre><xs:element name="ProspettoLiquidazione" type="m730:Prospetto_Liquidazione_Type" minOccurs="0"/></pre>

element **Dati_Contabili_Type/Annotazioni**

diagram	
namespace	urn:www.agenziaentrate.gov.it:specificheTecniche:sco:730:v1
type	m730:Annotazioni_Prospetto_Type
properties	isRef 0 content complex
children	m730:Codice m730:RigoQuadro m730:ModuloQuadro m730:Importo
source	<pre><xs:element name="Annotazioni" type="m730:Annotazioni_Prospetto_Type"/></pre>

complexType Dati_Contratto_Type

diagram					
namespace	urn:www.agenziaentrate.gov.it:specificheTecniche:sco:730:v1				
children	m730:DataRegContratto m730:SerieContratto m730:NumeroContratto m730:Sottonumero m730:CodiceUfficio				
used by	<table border="0"> <tr> <td>element</td> <td>FabbricatoAgev_Type/DatiContratto</td> </tr> <tr> <td>s</td> <td>Dati_Registrazione_Accatastamento_Recupero_Patrimonio_Edilizio_Type/EstremiRegistrazioneContratto</td> </tr> </table>	element	FabbricatoAgev_Type/DatiContratto	s	Dati_Registrazione_Accatastamento_Recupero_Patrimonio_Edilizio_Type/EstremiRegistrazioneContratto
element	FabbricatoAgev_Type/DatiContratto				
s	Dati_Registrazione_Accatastamento_Recupero_Patrimonio_Edilizio_Type/EstremiRegistrazioneContratto				
source	<pre> <xs:complexType name="Dati_Contratto_Type"> <xs:sequence> <xs:element name="DataRegContratto" type="cm:DatoDT_Type"/> <xs:element name="SerieContratto" type="m730:Serie_Registrazione_Contratto_Type"/> <xs:element name="NumeroContratto" type="cm:DatoAN_Type"/> <xs:element name="Sottonumero" type="cm:DatoAN_Type" minOccurs="0"/> <xs:element name="CodiceUfficio"> <xs:simpleType> <xs:restriction base="cm:DatoAN_Type"> <xs:length value="3"/> </xs:restriction> </xs:simpleType> </xs:element> </xs:sequence> </xs:complexType> </pre>				

element Dati_Contratto_Type/DataRegContratto

diagram										
namespace	urn:www.agenziaentrate.gov.it:specificheTecniche:sco:730:v1									
type	DatoDT_Type									
properties	<table border="0"> <tr> <td>isRef</td> <td>0</td> </tr> <tr> <td>content</td> <td>simple</td> </tr> </table>	isRef	0	content	simple					
isRef	0									
content	simple									
facets	<table border="0"> <tr> <td>Kind</td> <td>Value</td> <td>annotation</td> </tr> <tr> <td>length</td> <td>8</td> <td></td> </tr> <tr> <td>pattern</td> <td colspan="2">(((0[1-9]][12][0-9]][301])(0[13578][1012](\d{4})) (((0[1-9]][12][0-9]][30](0[469][11](\d{4})) ((0[1-</td> </tr> </table>	Kind	Value	annotation	length	8		pattern	(((0[1-9]][12][0-9]][301])(0[13578][1012](\d{4})) (((0[1-9]][12][0-9]][30](0[469][11](\d{4})) ((0[1-	
Kind	Value	annotation								
length	8									
pattern	(((0[1-9]][12][0-9]][301])(0[13578][1012](\d{4})) (((0[1-9]][12][0-9]][30](0[469][11](\d{4})) ((0[1-									

	9][1[0-9]2[0-8](02)(\d{4}))((29)(02)([02468][048]00))((29)(02)([13579][26]00))((29)(02)([0-9][0-9][0][48]))((29)(02)([0-9][0-9][2468][048]))((29)(02)([0-9][0-9][13579][26]))
source	<code><xs:element name="DataRegContratto" type="cm:DatoDT_Type"/></code>

element Dati_Contratto_Type/SerieContratto

diagram	
namespace	urn:www.agenziaentrate.gov.it:specificheTecniche:sco:730:v1
type	m730:Serie_Registrazione_Contratto_Type
properties	isRef 0 content simple
facets	Kind Value annotation pattern [0-9A-Z-]{1}([0-9A-Z] \- \. & , s / ° °\ (\))* enumeration 3 enumeration 3A enumeration 3B enumeration 3P enumeration 3T
source	<code><xs:element name="SerieContratto" type="m730:Serie_Registrazione_Contratto_Type"/></code>

element Dati_Contratto_Type/NumeroContratto

diagram	
namespace	urn:www.agenziaentrate.gov.it:specificheTecniche:sco:730:v1
type	DatoAN_Type
properties	isRef 0 content simple
facets	Kind Value annotation pattern [0-9A-Z-]{1}([0-9A-Z] \- \. & , s / ° °\ (\))*
source	<code><xs:element name="NumeroContratto" type="cm:DatoAN_Type"/></code>

element Dati_Contratto_Type/Sottonumero

diagram	
namespace	urn:www.agenziaentrate.gov.it:specificheTecniche:sco:730:v1
type	DatoAN_Type
properties	isRef 0 minOcc 0 maxOcc 1 content simple
facets	Kind Value annotation pattern [0-9A-Z-]{1}([0-9A-Z] \- \. & , s / ° °\ (\))*

source	<pre><xs:element name="Sottonumero" type="cm:DatoAN_Type" minOccurs="0"/></pre>
--------	---

element Dati_Contratto_Type/CodiceUfficio

diagram	
namespace	urn:www.agenziaentrate.gov.it:specificheTecniche:sco:730:v1
type	restriction of DatoAN_Type
properties	isRef 0 content simple
facets	Kind Value annotation length 3 pattern [0-9A-Z]{1}([0-9A-Z] \- \. & _ / \° \^\ \)*
source	<pre><xs:element name="CodiceUfficio"> <xs:simpleType> <xs:restriction base="cm:DatoAN_Type"> <xs:length value="3"/> </xs:restriction> </xs:simpleType> </xs:element></pre>

complexType Dati_F24_Imu_Type

diagram	
namespace	urn:www.agenziaentrate.gov.it:specificheTecniche:sco:730:v1
children	m730:ImportoIrpef m730:CodAddReg m730:ImportoAddReg m730:CodiceAddCom m730:ImportoAddCom m730:ImportoCedolare m730:m730Totale
used by	element Primo Modulo_PL_Type/DatiF24IMU
source	<pre><xs:complexType name="Dati_F24_Imu_Type"> <xs:sequence> <xs:element name="ImportoIrpef" type="cm:DatoNP_Type" minOccurs="0"/></pre>

	<pre> <xs:element name="CodAddReg" type="cm:DatoNP_Type" minOccurs="0"/> <xs:element name="ImportoAddReg" type="cm:DatoNP_Type" minOccurs="0"/> <xs:element name="CodiceAddCom" type="cm:DatoNP_Type" minOccurs="0"/> <xs:element name="ImportoAddCom" type="cm:DatoNP_Type" minOccurs="0"/> <xs:element name="ImportoCedolare" type="cm:DatoNP_Type" minOccurs="0"/> <xs:element name="m730Totale" type="cm:DatoNP_Type" minOccurs="0"/> </xs:sequence> </xs:complexType> </pre>
--	---

element Dati_F24_Imu_Type/ImportoIrpef

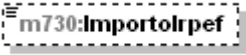
diagram									
namespace	urn:www.agenziaentrate.gov.it:specificheTecniche:sco:730:v1								
type	DatoNP_Type								
properties	<table border="0"> <tr><td>isRef</td><td>0</td></tr> <tr><td>minOcc</td><td>0</td></tr> <tr><td>maxOcc</td><td>1</td></tr> <tr><td>content</td><td>simple</td></tr> </table>	isRef	0	minOcc	0	maxOcc	1	content	simple
isRef	0								
minOcc	0								
maxOcc	1								
content	simple								
facets	<table border="0"> <tr><td>Kind</td><td>Value</td><td>annotation</td></tr> <tr><td>pattern</td><td>[1-9]{1}[0-9]*</td><td></td></tr> </table>	Kind	Value	annotation	pattern	[1-9]{1}[0-9]*			
Kind	Value	annotation							
pattern	[1-9]{1}[0-9]*								
source	<pre><xs:element name="ImportoIrpef" type="cm:DatoNP_Type" minOccurs="0"/></pre>								

element Dati_F24_Imu_Type/CodAddReg

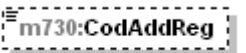
diagram									
namespace	urn:www.agenziaentrate.gov.it:specificheTecniche:sco:730:v1								
type	DatoNP_Type								
properties	<table border="0"> <tr><td>isRef</td><td>0</td></tr> <tr><td>minOcc</td><td>0</td></tr> <tr><td>maxOcc</td><td>1</td></tr> <tr><td>content</td><td>simple</td></tr> </table>	isRef	0	minOcc	0	maxOcc	1	content	simple
isRef	0								
minOcc	0								
maxOcc	1								
content	simple								
facets	<table border="0"> <tr><td>Kind</td><td>Value</td><td>annotation</td></tr> <tr><td>pattern</td><td>[1-9]{1}[0-9]*</td><td></td></tr> </table>	Kind	Value	annotation	pattern	[1-9]{1}[0-9]*			
Kind	Value	annotation							
pattern	[1-9]{1}[0-9]*								
source	<pre><xs:element name="CodAddReg" type="cm:DatoNP_Type" minOccurs="0"/></pre>								

element **Dati_F24_Imu_Type/ImportoAddReg**

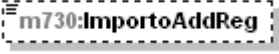
diagram	
namespace	urn:www.agenziaentrate.gov.it:specificheTecniche:sco:730:v1
type	DatoNP_Type
properties	isRef 0 minOcc 0 maxOcc 1 content simple
facets	Kind Value annotation pattern [1-9]{1}[0-9]*
source	<pre><xs:element name="ImportoAddReg" type="cm:DatoNP_Type" minOccurs="0"/></pre>

element **Dati_F24_Imu_Type/CodiceAddCom**

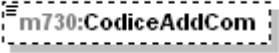
diagram	
namespace	urn:www.agenziaentrate.gov.it:specificheTecniche:sco:730:v1
type	DatoNP_Type
properties	isRef 0 minOcc 0 maxOcc 1 content simple
facets	Kind Value annotation pattern [1-9]{1}[0-9]*
source	<pre><xs:element name="CodiceAddCom" type="cm:DatoNP_Type" minOccurs="0"/></pre>

element **Dati_F24_Imu_Type/ImportoAddCom**

diagram	
namespace	urn:www.agenziaentrate.gov.it:specificheTecniche:sco:730:v1
type	DatoNP_Type
properties	isRef 0 minOcc 0 maxOcc 1 content simple
facets	Kind Value annotation pattern [1-9]{1}[0-9]*
source	<pre><xs:element name="ImportoAddCom" type="cm:DatoNP_Type" minOccurs="0"/></pre>

element **Dati_F24_Imu_Type/ImportoCedolare**

diagram	
namespace	urn:www.agenziaentrate.gov.it:specificheTecniche:sco:730:v1
type	DatoNP_Type
properties	isRef 0 minOcc 0 maxOcc 1 content simple
facets	Kind Value annotation pattern [1-9]{1}[0-9]*
source	<pre><xs:element name="ImportoCedolare" type="cm:DatoNP_Type" minOccurs="0"/></pre>

element **Dati_F24_Imu_Type/m730Totale**

diagram	
namespace	urn:www.agenziaentrate.gov.it:specificheTecniche:sco:730:v1
type	DatoNP_Type
properties	isRef 0 minOcc 0 maxOcc 1 content simple
facets	Kind Value annotation pattern [1-9]{1}[0-9]*
source	<pre><xs:element name="m730Totale" type="cm:DatoNP_Type" minOccurs="0"/></pre>

complexType **Dati_Familiare_Type**

diagram	
namespace	urn:www.agenziaentrate.gov.it:specificheTecniche:sco:730:v1
children	m730:CodiceFiscale m730:Mesi m730:MesiMinore m730:PercDetraz m730:PercDetrazCon m730:Affidamento
used by	elements Familiari PrimoModulo_Type/Familiari Modulo Familiari_Type/Familiari Familiari PrimoModulo_Type/PrimoFiglio Modulo Familiari_Type/PrimoFiglio

source	<pre> <xs:complexType name="Dati_Familiare_Type"> <xs:sequence> <xs:element name="CodiceFiscale" type="cm:DatoCF_Type" minOccurs="0"/> <xs:element name="Mesi" type="cm:DatoNP_Type"/> <xs:element name="MesiMinore" type="cm:DatoNP_Type" minOccurs="0"/> <xs:choice> <xs:element name="PercDetraz" type="cm:DatoPC_Type"/> <xs:element name="PercDetrazCon" type="cm:DatoAN_Type"/> </xs:choice> <xs:element name="Affidamento" type="cm:DatoCB_Type" minOccurs="0"/> </xs:sequence> </xs:complexType> </pre>
--------	---

element Dati_Familiare_Type/CodiceFiscale

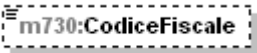
diagram		
namespace	urn:www.agenziaentrate.gov.it:specificheTecniche:sco:730:v1	
type	DatoCF_Type	
properties	isRef 0 minOcc 0 maxOcc 1 content simple	
facets	Kind Value pattern [0-9]{11}[A-Z]{6}[0-9LMNPQRSTUUV]{2}[A-Z]{1}[0-9LMNPQRSTUUV]{2}[A-Z]{1}[0-9LMNPQRSTUUV]{3}[A-Z]{1}	annotation
source	<pre> <xs:element name="CodiceFiscale" type="cm:DatoCF_Type" minOccurs="0"/> </pre>	

element Dati_Familiare_Type/Mesi

diagram		
namespace	urn:www.agenziaentrate.gov.it:specificheTecniche:sco:730:v1	
type	DatoNP_Type	
properties	isRef 0 content simple	
facets	Kind Value pattern [1-9]{1}[0-9]*	annotation
source	<pre> <xs:element name="Mesi" type="cm:DatoNP_Type"/> </pre>	

element Dati_Familiare_Type/MesiMinore

diagram	
namespace	urn:www.agenziaentrate.gov.it:specificheTecniche:sco:730:v1
type	DatoNP_Type
properties	isRef 0 minOcc 0 maxOcc 1 content simple
facets	Kind Value annotation pattern [1-9]{1}[0-9]*
source	<pre><xs:element name="MesiMinore" type="cm:DatoNP_Type" minOccurs="0"/></pre>

element Dati_Familiare_Type/PercDetraz

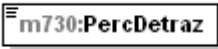
diagram	
namespace	urn:www.agenziaentrate.gov.it:specificheTecniche:sco:730:v1
type	DatoPC_Type
properties	isRef 0 content simple
facets	Kind Value annotation maxLength 16 pattern [0-9]?[0-9](\d{1,3})? 100(,0{1,3})?
source	<pre><xs:element name="PercDetraz" type="cm:DatoPC_Type"/></pre>

element Dati_Familiare_Type/PercDetrazCon

diagram	
namespace	urn:www.agenziaentrate.gov.it:specificheTecniche:sco:730:v1
type	DatoAN_Type
properties	isRef 0 content simple
facets	Kind Value annotation pattern [0-9A-Z-]{1}([0-9A-Z] [-\.\& ; \/ \° ^\ \()]*
source	<pre><xs:element name="PercDetrazCon" type="cm:DatoAN_Type"/></pre>

element Dati_Familiare_Type/Affidamento

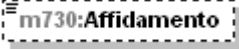
diagram	
namespace	urn:www.agenziaentrate.gov.it:specificheTecniche:sco:730:v1
type	DatoCB_Type

properties	isRef 0 minOcc 0 maxOcc 1 content simple
facets	Kind Value annotation pattern [01]
source	<code><xs:element name="Affidamento" type="cm:DatoCB_Type" minOccurs="0"/></code>

complexType Dati_Nascita_PF_Type

diagram	
namespace	urn:www.agenziaentrate.gov.it:specificheTecniche:sco:730:v1
children	m730:Sesso m730:DataNascita m730:ComuneNascita m730:ProvinciaNascita
used by	elements Soggetto Assistenza FiscaliDoc type/DatiProfessionistaDoc/DatiNascitaProfessionista Soggetto Assistenza FiscaliDoc type/DatiAssociazioneDoc/DatiNascitaProfessionista
source	<pre> <xs:complexType name="Dati_Nascita_PF_Type"> <xs:sequence> <xs:element name="Sesso" type="sc:Sesso_Type"/> <xs:element name="DataNascita" type="cm:DatoDT_Type"/> <xs:element name="ComuneNascita" type="cm:DatoAN_Type"/> <xs:element name="ProvinciaNascita" type="cm:PN_Type" minOccurs="0"/> </xs:sequence> </xs:complexType> </pre>

element Dati_Nascita_PF_Type/Sesso

diagram	
namespace	urn:www.agenziaentrate.gov.it:specificheTecniche:sco:730:v1
type	Sesso_Type
properties	isRef 0 content simple
facets	Kind Value annotation pattern [0-9A-Z]{1}([0-9A-Z] \- \. & _ s / ° ^\ ())* enumeration M documentation <![CDATA[Maschio]]> enumeration F documentation <![CDATA[Femmina]]>
source	<code><xs:element name="Sesso" type="sc:Sesso_Type"/></code>

element **Dati_Nascita_PF_Type/DataNascita**

diagram	
namespace	urn:www.agenziaentrate.gov.it:specificheTecniche:sco:730:v1
type	DatoDT_Type
properties	isRef 0 content simple
facets	Kind Value annotation length 8 pattern ((([0-9][12][0-9]3[01])([0-9]13578)[10]12)(\d{4}))(((0[1-9][1-9][12][0-9]30)(0[469]11)(\d{4}))((0[1-9]1[0-9]2[0-8](02)(\d{4}))((29)(02)([02468][048]00))((29)(02)([13579][26]00))((29)(02)([0-9][0-9][0][48]))((29)(02)([0-9][0-9][2468][048]))((29)(02)([0-9][0-9][13579][26]))))
source	<code><xs:element name="DataNascita" type="cm:DatoDT_Type"/></code>

element **Dati_Nascita_PF_Type/ComuneNascita**

diagram	
namespace	urn:www.agenziaentrate.gov.it:specificheTecniche:sco:730:v1
type	DatoAN_Type
properties	isRef 0 content simple
facets	Kind Value annotation pattern [0-9A-Z-]{1}([0-9A-Z] \- \. & _ \\s / ^ \(\))*
source	<code><xs:element name="ComuneNascita" type="cm:DatoAN_Type"/></code>

element **Dati_Nascita_PF_Type/ProvinciaNascita**

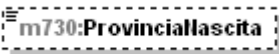
diagram	
namespace	urn:www.agenziaentrate.gov.it:specificheTecniche:sco:730:v1
type	PN_Type
properties	isRef 0 minOcc 0 maxOcc 1 content simple
source	<code><xs:element name="ProvinciaNascita" type="cm:PN_Type" minOccurs="0"/></code>

complexType Dati_Primo_Figlio_Type

diagram	
namespace	urn:www.agenziaentrate.gov.it:specificheTecniche:sco:730:v1
children	m730:Tipo m730:CodiceFiscale m730:Mesi m730:MesiMinore m730:PercDetraz m730:Affidamento
source	<pre> <xs:complexType name="Dati_Primo_Figlio_Type"> <xs:sequence> <xs:element name="Tipo"> <xs:simpleType> <xs:restriction base="cm:DatoAN_Type"> <xs:enumeration value="F"/> <xs:enumeration value="D"/> </xs:restriction> </xs:simpleType> </xs:element> <xs:element name="CodiceFiscale" type="cm:DatoCF_Type" minOccurs="0"/> <xs:element name="Mesi" type="m730:Mesi_Type"/> <xs:element name="MesiMinore" type="m730:Mesi_Type" minOccurs="0"/> <xs:element name="PercDetraz" type="cm:DatoPC_Type" minOccurs="0"/> <xs:element name="Affidamento" type="cm:DatoCB_Type" minOccurs="0"/> </xs:sequence> </xs:complexType> </pre>

element Dati_Primo_Figlio_Type/Tipo

diagram	
namespace	urn:www.agenziaentrate.gov.it:specificheTecniche:sco:730:v1
type	restriction of DatoAN_Type
properties	isRef 0 content simple
facets	Kind Value annotation pattern [0-9A-Z]{1}([0-9A-Z] ' \" , . / ° \\ ()*)

	enumeration F enumeration D
source	<pre> <xs:element name="Tipo"> <xs:simpleType> <xs:restriction base="cm:DatoAN_Type"> <xs:enumeration value="F"/> <xs:enumeration value="D"/> </xs:restriction> </xs:simpleType> </xs:element> </pre>

element Dati_Primo_Figlio_Type/CodiceFiscale

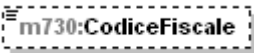
diagram							
namespace	urn:www.agenziaentrate.gov.it:specificheTecniche:sco:730:v1						
type	DatoCF_Type						
properties	isRef 0 minOcc 0 maxOcc 1 content simple						
facets	<table border="0"> <tr> <td>Kind</td> <td>Value</td> <td>annotation</td> </tr> <tr> <td>pattern</td> <td>[0-9]{11}[A-Z]{6}[0-9LMNPQRSTUUV]{2}[A-Z]{1}[0-9LMNPQRSTUUV]{2}[A-Z]{1}[0-9LMNPQRSTUUV]{3}[A-Z]{1}</td> <td></td> </tr> </table>	Kind	Value	annotation	pattern	[0-9]{11}[A-Z]{6}[0-9LMNPQRSTUUV]{2}[A-Z]{1}[0-9LMNPQRSTUUV]{2}[A-Z]{1}[0-9LMNPQRSTUUV]{3}[A-Z]{1}	
Kind	Value	annotation					
pattern	[0-9]{11}[A-Z]{6}[0-9LMNPQRSTUUV]{2}[A-Z]{1}[0-9LMNPQRSTUUV]{2}[A-Z]{1}[0-9LMNPQRSTUUV]{3}[A-Z]{1}						
source	<pre> <xs:element name="CodiceFiscale" type="cm:DatoCF_Type" minOccurs="0"/> </pre>						

element Dati_Primo_Figlio_Type/Mesi

diagram																																					
namespace	urn:www.agenziaentrate.gov.it:specificheTecniche:sco:730:v1																																				
type	m730:Mesi_Type																																				
properties	isRef 0 content simple																																				
facets	<table border="0"> <tr> <td>Kind</td> <td>Value</td> <td>annotation</td> </tr> <tr> <td>pattern</td> <td>[1-9]{1}[0-9]*</td> <td></td> </tr> <tr> <td>enumeration</td> <td>1</td> <td></td> </tr> <tr> <td>enumeration</td> <td>2</td> <td></td> </tr> <tr> <td>enumeration</td> <td>3</td> <td></td> </tr> <tr> <td>enumeration</td> <td>4</td> <td></td> </tr> <tr> <td>enumeration</td> <td>5</td> <td></td> </tr> <tr> <td>enumeration</td> <td>6</td> <td></td> </tr> <tr> <td>enumeration</td> <td>7</td> <td></td> </tr> <tr> <td>enumeration</td> <td>8</td> <td></td> </tr> <tr> <td>enumeration</td> <td>9</td> <td></td> </tr> <tr> <td>enumeration</td> <td>10</td> <td></td> </tr> </table>	Kind	Value	annotation	pattern	[1-9]{1}[0-9]*		enumeration	1		enumeration	2		enumeration	3		enumeration	4		enumeration	5		enumeration	6		enumeration	7		enumeration	8		enumeration	9		enumeration	10	
Kind	Value	annotation																																			
pattern	[1-9]{1}[0-9]*																																				
enumeration	1																																				
enumeration	2																																				
enumeration	3																																				
enumeration	4																																				
enumeration	5																																				
enumeration	6																																				
enumeration	7																																				
enumeration	8																																				
enumeration	9																																				
enumeration	10																																				

	enumeration 11 enumeration 12
source	<code><xs:element name="Mesi" type="m730:Mesi_Type"/></code>

element Dati_Primo_Figlio_Type/MesiMinore

diagram																																											
namespace	urn:www.agenziaentrate.gov.it:specificheTecniche:sco:730:v1																																										
type	m730:Mesi_Type																																										
properties	isRef 0 minOcc 0 maxOcc 1 content simple																																										
facets	<table border="1"> <thead> <tr> <th>Kind</th> <th>Value</th> <th>annotation</th> </tr> </thead> <tbody> <tr> <td>pattern</td> <td>[1-9]{1}[0-9]*</td> <td></td> </tr> <tr> <td>enumeration</td> <td>1</td> <td></td> </tr> <tr> <td>enumeration</td> <td>2</td> <td></td> </tr> <tr> <td>enumeration</td> <td>3</td> <td></td> </tr> <tr> <td>enumeration</td> <td>4</td> <td></td> </tr> <tr> <td>enumeration</td> <td>5</td> <td></td> </tr> <tr> <td>enumeration</td> <td>6</td> <td></td> </tr> <tr> <td>enumeration</td> <td>7</td> <td></td> </tr> <tr> <td>enumeration</td> <td>8</td> <td></td> </tr> <tr> <td>enumeration</td> <td>9</td> <td></td> </tr> <tr> <td>enumeration</td> <td>10</td> <td></td> </tr> <tr> <td>enumeration</td> <td>11</td> <td></td> </tr> <tr> <td>enumeration</td> <td>12</td> <td></td> </tr> </tbody> </table>	Kind	Value	annotation	pattern	[1-9]{1}[0-9]*		enumeration	1		enumeration	2		enumeration	3		enumeration	4		enumeration	5		enumeration	6		enumeration	7		enumeration	8		enumeration	9		enumeration	10		enumeration	11		enumeration	12	
Kind	Value	annotation																																									
pattern	[1-9]{1}[0-9]*																																										
enumeration	1																																										
enumeration	2																																										
enumeration	3																																										
enumeration	4																																										
enumeration	5																																										
enumeration	6																																										
enumeration	7																																										
enumeration	8																																										
enumeration	9																																										
enumeration	10																																										
enumeration	11																																										
enumeration	12																																										
source	<code><xs:element name="MesiMinore" type="m730:Mesi_Type" minOccurs="0"/></code>																																										

element Dati_Primo_Figlio_Type/PercDetraz

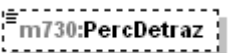
diagram										
namespace	urn:www.agenziaentrate.gov.it:specificheTecniche:sco:730:v1									
type	DatoPC_Type									
properties	isRef 0 minOcc 0 maxOcc 1 content simple									
facets	<table border="1"> <thead> <tr> <th>Kind</th> <th>Value</th> <th>annotation</th> </tr> </thead> <tbody> <tr> <td>maxLength</td> <td>16</td> <td></td> </tr> <tr> <td>pattern</td> <td>[0-9]?[0-9](\d{1,3})? 100(,0{1,3})?</td> <td></td> </tr> </tbody> </table>	Kind	Value	annotation	maxLength	16		pattern	[0-9]?[0-9](\d{1,3})? 100(,0{1,3})?	
Kind	Value	annotation								
maxLength	16									
pattern	[0-9]?[0-9](\d{1,3})? 100(,0{1,3})?									
source	<code><xs:element name="PercDetraz" type="cm:DatoPC_Type" minOccurs="0"/></code>									

element **Dati_Primo_Figlio_Type/Affidamento**

diagram	
namespace	urn:www.agenziaentrate.gov.it:specificheTecniche:sco:730:v1
type	DatoCB_Type
properties	isRef 0 minOcc 0 maxOcc 1 content simple
facets	Kind Value annotation pattern [01]
source	<pre><xs:element name="Affidamento" type="cm:DatoCB_Type" minOccurs="0"/></pre>

complexType **Dati_Professionista_Type**

diagram	
namespace	urn:www.agenziaentrate.gov.it:specificheTecniche:sco:730:v1
children	m730:CFProfessionista m730:CognomeProfessionista m730:NomeProfessionista
used by	elements Documento_730-4/SoggettoAssFiscale730-4/DatiProfessionista730-4 Soggetto_Assistenza_FiscaliDoc_type/DatiProfessionistaDoc
source	<pre><xs:complexType name="Dati_Professionista_Type"> <xs:sequence> <xs:element name="CFProfessionista" type="cm:DatoCF_Type"/> <xs:element name="CognomeProfessionista" type="cm:DatoAN_Type"/> <xs:element name="NomeProfessionista" type="cm:DatoAN_Type"/> </xs:sequence> </xs:complexType></pre>

element **Dati_Professionista_Type/CFProfessionista**

diagram	
namespace	urn:www.agenziaentrate.gov.it:specificheTecniche:sco:730:v1
type	DatoCF_Type
properties	isRef 0 content simple

facets	Kind pattern	Value [0-9]{11}[A-Z]{6}[0-9LMNPQRSTUUV]{2}[A-Z]{1}[0-9LMNPQRSTUUV]{2}[A-Z]{1}[0-9LMNPQRSTUUV]{3}[A-Z]{1}	annotation
source	<code><xs:element name="CFProfessionista" type="cm:DatoCF_Type"/></code>		

element Dati_Professionista_Type/CognomeProfessionista

diagram			
namespace	urn:www.agenziaentrate.gov.it:specificheTecniche:sco:730:v1		
type	DatoAN_Type		
properties	isRef	0	
	content	simple	
facets	Kind pattern	Value [0-9A-Z]{1}([0-9A-Z] \- \. & , \s / ° °\(\))*	annotation
source	<code><xs:element name="CognomeProfessionista" type="cm:DatoAN_Type"/></code>		

element Dati_Professionista_Type/NomeProfessionista

diagram			
namespace	urn:www.agenziaentrate.gov.it:specificheTecniche:sco:730:v1		
type	DatoAN_Type		
properties	isRef	0	
	content	simple	
facets	Kind pattern	Value [0-9A-Z]{1}([0-9A-Z] \- \. & , \s / ° °\(\))*	annotation
source	<code><xs:element name="NomeProfessionista" type="cm:DatoAN_Type"/></code>		

complexType Dati_Registrazione_Accatastamento_Recupero_Patrimonio_Edilizio_Type

diagram			
namespace	urn:www.agenziaentrate.gov.it:specificheTecniche:sco:730:v1		
children	m730:NomeImmobilare m730:COPescaraCondominio m730:EstremiRegistrazioneContratto		

	m730:DataDomandaAccatastamento m730:NumeroDomandaAccatastamento m730:CodiceUfficioDomandaAccatastamento
used by	element Sezione Dati Catastali Recupero Patrimonio Edilizio Type/DatiRegistrazioneAccatastamentoRecupero Patrimonio Edilizio
source	<pre> <xs:complexType name="Dati_Registrazione_Accatastamento_Recupero_Patrimonio_Ed ilizio_Type"> <xs:sequence> <xs:element name="NOrdImmobile" type="cm:DatoNP_Type"/> <xs:element name="COPescaraCondominio" type="cm:DatoCB_Type" minOccurs="0"/> <xs:element name="EstremiRegistrazioneContratto" type="m730:Dati_Contratto_Type" minOccurs="0"/> <xs:element name="DataDomandaAccatastamento" type="cm:DatoDT_Type" minOccurs="0"/> <xs:element name="NumeroDomandaAccatastamento" type="cm:DatoAN_Type" minOccurs="0"/> <xs:element name="CodiceUfficioDomandaAccatastamento" type="cm:DatoAN_Type" minOccurs="0"/> </xs:sequence> </xs:complexType> </pre>

element [Dati_Registrazione_Accatastamento_Recupero_Patrimonio_Edilizio_Type/NOrdImmobile](#)

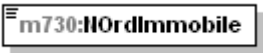
diagram	
namespace	urn:www.agenziaentrate.gov.it:specificheTecniche:sco:730:v1
type	DatoNP_Type
properties	isRef 0 content simple
facets	Kind Value annotation pattern [1-9]{1}[0-9]*
source	<pre><xs:element name="NOrdImmobile" type="cm:DatoNP_Type"/></pre>

element

[Dati_Registrazione_Accatastamento_Recupero_Patrimonio_Edilizio_Type/COPescaraCondominio](#)

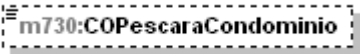
diagram	
namespace	urn:www.agenziaentrate.gov.it:specificheTecniche:sco:730:v1
type	DatoCB_Type
properties	isRef 0 minOcc 0 maxOcc 1 content simple
facets	Kind Value annotation pattern [01]

source	<code><xs:element name="COPescaraCondominio" type="cm:DatoCB_Type" minOccurs="0"/></code>
--------	---

element

Dati_Registrazione_Accatastamento_Recupero_Patrimonio_Edilizio_Type/EstremiRegistrazioneContratto

diagram	
namespace	urn:www.agenziaentrate.gov.it:specificheTecniche:sco:730:v1
type	m730:Dati_Contratto_Type
properties	isRef 0 minOcc 0 maxOcc 1 content complex
children	m730:DataRegContratto m730:SerieContratto m730:NumeroContratto m730:Sottonumero m730:CodiceUfficio
source	<code><xs:element name="EstremiRegistrazioneContratto" type="m730:Dati_Contratto_Type" minOccurs="0"/></code>

element

Dati_Registrazione_Accatastamento_Recupero_Patrimonio_Edilizio_Type/DataDomandaAccatastamento

diagram	
namespace	urn:www.agenziaentrate.gov.it:specificheTecniche:sco:730:v1
type	DatoDT_Type
properties	isRef 0 minOcc 0 maxOcc 1 content simple
facets	Kind Value annotation length 8 pattern (((0[1-9] 12 0-9]3 01))(0[13578] 10 12)(\d{4}))(((0[1-9] 12 0-9]30)(0[469] 11)(\d{4}))(((0[1-9] 1[0-9]2 0-8)(02)(\d{4}))(((29)(02)([02468] 048 00))(((29)(02)([13579] 26 00))(((29)(02)([0-9] 0-9]0[48]))(((29)(02)([0-9] 0-9]2468 048))(((29)(02)([0-9] 0-9]13579 26))))))
source	<code><xs:element name="DataDomandaAccatastamento" type="cm:DatoDT_Type" minOccurs="0"/></code>

element

Dati_Registrazione_Accatastamento_Recupero_Patrimonio_Edilizio_Type/NumeroDomandaAccatastamento

diagram	
namespace	urn:www.agenziaentrate.gov.it:specificheTecniche:sco:730:v1
type	DatoAN_Type
properties	isRef 0 minOcc 0 maxOcc 1 content simple
facets	Kind Value annotation pattern [0-9A-Z-]{1}([0-9A-Z] \. \- \& , \/ \° \^ \(\))*
source	<pre><xs:element name="NumeroDomandaAccatastamento" type="cm:DatoAN_Type" minOccurs="0"/></pre>

element

Dati_Registrazione_Accatastamento_Recupero_Patrimonio_Edilizio_Type/CodiceUfficioDomandaAccatastamento

diagram	
namespace	urn:www.agenziaentrate.gov.it:specificheTecniche:sco:730:v1
type	DatoAN_Type
properties	isRef 0 minOcc 0 maxOcc 1 content simple
facets	Kind Value annotation pattern [0-9A-Z-]{1}([0-9A-Z] \. \- \& , \/ \° \^ \(\))*
source	<pre><xs:element name="CodiceUfficioDomandaAccatastamento" type="cm:DatoAN_Type" minOccurs="0"/></pre>

complexType Debito_Type

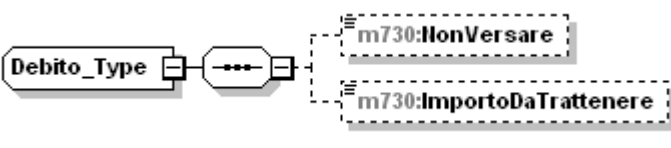
diagram	
namespace	urn:www.agenziaentrate.gov.it:specificheTecniche:sco:730:v1
children	m730:NonVersare m730:ImportoDaTrattenere
used by	elements Primo Modulo PL_Type/LiquidazioneImposte/AccontoTassSep Primo Modulo PL_Type/LiquidazioneImposte/ContribSolidarietàDebito Esito Liquidazione_Type/Debito Primo Modulo PL_Type/LiquidazioneImposte/ImpSostProdut
source	<pre><xs:complexType name="Debito_Type"> <xs:sequence></pre>

	<pre> <xs:element name="NonVersare" type="cm:DatoNP_Type" minOccurs="0"/> <xs:element name="ImportoDaTrattenerere" type="cm:DatoNP_Type" minOccurs="0"/> </xs:sequence> </xs:complexType> </pre>
--	--

element Debito_Type/NonVersare

diagram									
namespace	urn:www.agenziaentrate.gov.it:specificheTecniche:sco:730:v1								
type	DatoNP_Type								
properties	<table border="0"> <tr><td>isRef</td><td>0</td></tr> <tr><td>minOcc</td><td>0</td></tr> <tr><td>maxOcc</td><td>1</td></tr> <tr><td>content</td><td>simple</td></tr> </table>	isRef	0	minOcc	0	maxOcc	1	content	simple
isRef	0								
minOcc	0								
maxOcc	1								
content	simple								
facets	<table border="0"> <tr><td>Kind</td><td>Value</td><td>annotation</td></tr> <tr><td>pattern</td><td>[1-9]{1}[0-9]*</td><td></td></tr> </table>	Kind	Value	annotation	pattern	[1-9]{1}[0-9]*			
Kind	Value	annotation							
pattern	[1-9]{1}[0-9]*								
source	<pre><xs:element name="NonVersare" type="cm:DatoNP_Type" minOccurs="0"/></pre>								

element Debito_Type/ImportoDaTrattenerere

diagram									
namespace	urn:www.agenziaentrate.gov.it:specificheTecniche:sco:730:v1								
type	DatoNP_Type								
properties	<table border="0"> <tr><td>isRef</td><td>0</td></tr> <tr><td>minOcc</td><td>0</td></tr> <tr><td>maxOcc</td><td>1</td></tr> <tr><td>content</td><td>simple</td></tr> </table>	isRef	0	minOcc	0	maxOcc	1	content	simple
isRef	0								
minOcc	0								
maxOcc	1								
content	simple								
facets	<table border="0"> <tr><td>Kind</td><td>Value</td><td>annotation</td></tr> <tr><td>pattern</td><td>[1-9]{1}[0-9]*</td><td></td></tr> </table>	Kind	Value	annotation	pattern	[1-9]{1}[0-9]*			
Kind	Value	annotation							
pattern	[1-9]{1}[0-9]*								
source	<pre><xs:element name="ImportoDaTrattenerere" type="cm:DatoNP_Type" minOccurs="0"/></pre>								

complexType Deduzioni_Modulo_Type

diagram	
namespace	urn:www.agenziaentrate.gov.it:specificheTecniche:sco:730:v1
children	m730:AssegnoConiuge m730:AltriOneri
used by	element Modulo_Oneri_Type/SpeseDeduzioni

source	<pre><xs:complexType name="Deduzioni_Modulo_Type"> <xs:sequence> <xs:element name="AssegnoConiuge" type="m730:Assegno_Coniuge_Type" minOccurs="0"/> <xs:element name="AltriOneri" type="m730:Altri_Oneri_Type" minOccurs="0"/> </xs:sequence> </xs:complexType></pre>
--------	---

element Deduzioni_Modulo_Type/AssegnoConiuge

diagram									
namespace	urn:www.agenziaentrate.gov.it:specificheTecniche:sco:730:v1								
type	m730:Assegno_Coniuge_Type								
properties	<table border="0"> <tr><td>isRef</td><td>0</td></tr> <tr><td>minOcc</td><td>0</td></tr> <tr><td>maxOcc</td><td>1</td></tr> <tr><td>content</td><td>complex</td></tr> </table>	isRef	0	minOcc	0	maxOcc	1	content	complex
isRef	0								
minOcc	0								
maxOcc	1								
content	complex								
children	m730:CodiceFiscale m730:Importo								
source	<pre><xs:element name="AssegnoConiuge" type="m730:Assegno_Coniuge_Type" minOccurs="0"/></pre>								

element Deduzioni_Modulo_Type/AltriOneri

diagram									
namespace	urn:www.agenziaentrate.gov.it:specificheTecniche:sco:730:v1								
type	m730:Altri_Oneri_Type								
properties	<table border="0"> <tr><td>isRef</td><td>0</td></tr> <tr><td>minOcc</td><td>0</td></tr> <tr><td>maxOcc</td><td>1</td></tr> <tr><td>content</td><td>complex</td></tr> </table>	isRef	0	minOcc	0	maxOcc	1	content	complex
isRef	0								
minOcc	0								
maxOcc	1								
content	complex								
children	m730:Codice m730:Importo								
source	<pre><xs:element name="AltriOneri" type="m730:Altri_Oneri_Type" minOccurs="0"/></pre>								

complexType **Deduzioni_Type**

<p>diagram</p>	
<p>namespace</p>	<p>urn:www.agenziaentrate.gov.it:specificheTecniche:sco:730:v1</p>
<p>children</p>	<p>m730:ContributiPrevAss m730:AssegnoConiuge m730:ContributiColf m730:ErogazioniIstituzioniReligiose m730:SpesePortatoriHandicap m730:AltriOneri m730:DeducibilitaOrdinaria m730:LavoratoriPrimaOccupazione m730:FondiInSquilibrioFinanziario m730:FamiliariACarico m730:FondoPensioneDipendentiPubblici</p>
<p>used by</p>	<p>element PrimoModulo_Oneri_Type/SpeseDeduzioni</p>
<p>source</p>	<pre><xs:complexType name="Deduzioni_Type"> <xs:sequence> <xs:element name="ContributiPrevAss" type="cm:DatoNP_Type" minOccurs="0"/> <xs:element name="AssegnoConiuge" type="m730:Assegno_Coniuge_Type" minOccurs="0"/> <xs:element name="ContributiColf" type="cm:DatoNP_Type" minOccurs="0"/> <xs:element name="ErogazioniIstituzioniReligiose" type="cm:DatoNP_Type" minOccurs="0"/> <xs:element name="SpesePortatoriHandicap" type="cm:DatoNP_Type" minOccurs="0"/> <xs:element name="AltriOneri" type="m730:Altri_Oneri_Type" minOccurs="0"/> <xs:element name="DeducibilitaOrdinaria" type="m730:Contributi_Previdenza_Complementare_Type" minOccurs="0"/> <xs:element name="LavoratoriPrimaOccupazione" type="m730:Contributi_Previdenza_Complementare_Type" minOccurs="0"/> </xs:sequence> </xs:complexType></pre>

	<pre> minOccurs="0"/> <xs:element name="FondiInSquilibrioFinanziario" type="m730:Contributi_Previdenza_Complementare_Type" minOccurs="0"/> <xs:element name="FamiliariACarico" type="m730:Contributi_Previdenza_Complementare_Type" minOccurs="0"/> <xs:element name="FondoPensioneDipendentiPubblici" type="m730:Fondo_Pensione_Dipendenti_Pubblici_Type" minOccurs="0"/> </xs:sequence> </xs:complexType> </pre>
--	---

element Deduzioni_Type/ContributiPrevAss

diagram	
namespace	urn:www.agenziaentrate.gov.it:specificheTecniche:sco:730:v1
type	DatoNP_Type
properties	isRef 0 minOcc 0 maxOcc 1 content simple
facets	Kind Value annotation pattern [1-9]{1}[0-9]*
source	<pre><xs:element name="ContributiPrevAss" type="cm:DatoNP_Type" minOccurs="0"/></pre>

element Deduzioni_Type/AssegnoConiuge

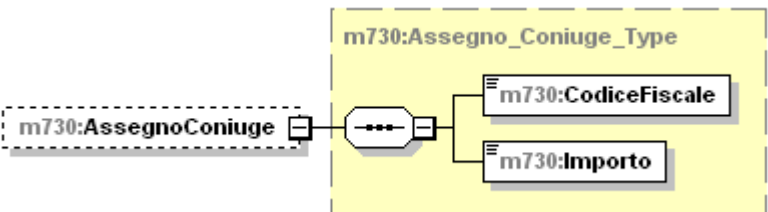
diagram	
namespace	urn:www.agenziaentrate.gov.it:specificheTecniche:sco:730:v1
type	m730:Assegno_Coniuge_Type
properties	isRef 0 minOcc 0 maxOcc 1 content complex
children	m730:CodiceFiscale m730:Importo
source	<pre><xs:element name="AssegnoConiuge" type="m730:Assegno_Coniuge_Type" minOccurs="0"/></pre>

element Deduzioni_Type/ContributiColf

diagram	
namespace	urn:www.agenziaentrate.gov.it:specificheTecniche:sco:730:v1
type	DatoNP_Type
properties	isRef 0 minOcc 0 maxOcc 1 content simple
facets	Kind Value annotation pattern [1-9]{1}[0-9]*
source	<pre><xs:element name="ContributiColf" type="cm:DatoNP_Type" minOccurs="0"/></pre>

element Deduzioni_Type/ErogazioniIstituzioniReligiose

diagram	
namespace	urn:www.agenziaentrate.gov.it:specificheTecniche:sco:730:v1
type	DatoNP_Type
properties	isRef 0 minOcc 0 maxOcc 1 content simple
facets	Kind Value annotation pattern [1-9]{1}[0-9]*
source	<pre><xs:element name="ErogazioniIstituzioniReligiose" type="cm:DatoNP_Type" minOccurs="0"/></pre>

element Deduzioni_Type/SpesePortatoriHandicap

diagram	
namespace	urn:www.agenziaentrate.gov.it:specificheTecniche:sco:730:v1
type	DatoNP_Type
properties	isRef 0 minOcc 0 maxOcc 1 content simple
facets	Kind Value annotation pattern [1-9]{1}[0-9]*
source	<pre><xs:element name="SpesePortatoriHandicap" type="cm:DatoNP_Type" minOccurs="0"/></pre>

element **Deduzioni_Type/AltriOneri**

diagram	
namespace	urn:www.agenziaentrate.gov.it:specificheTecniche:sco:730:v1
type	m730:Altri_Oneri_Type
properties	isRef 0 minOcc 0 maxOcc 1 content complex
children	m730:Codice m730:Importo
source	<pre><xs:element name="AltriOneri" type="m730:Altri_Oneri_Type" minOccurs="0"/></pre>

element **Deduzioni_Type/DeducibilitaOrdinaria**

diagram	
namespace	urn:www.agenziaentrate.gov.it:specificheTecniche:sco:730:v1
type	m730:Contributi_Previdenza_Complementare_Type
properties	isRef 0 minOcc 0 maxOcc 1 content complex
children	m730:EsclusiDalSostituto m730:NonEsclusiDalSostituto
source	<pre><xs:element name="DeducibilitaOrdinaria" type="m730:Contributi_Previdenza_Complementare_Type" minOccurs="0"/></pre>

element **Deduzioni_Type/LavoratoriPrimaOccupazione**

diagram	
namespace	urn:www.agenziaentrate.gov.it:specificheTecniche:sco:730:v1

type	m730:Contributi Previdenza Complementare Type
properties	isRef 0 minOcc 0 maxOcc 1 content complex
children	m730:EsclusiDalSostituto m730:NonEsclusiDalSostituto
source	<pre><xs:element name="LavoratoriPrimaOccupazione" type="m730:Contributi_Previdenza_Complementare_Type" minOccurs="0"/></pre>

element Deduzioni_Type/FondiInSquilibrioFinanziario

diagram	
namespace	urn:www.agenziaentrate.gov.it:specificheTecniche:sco:730:v1
type	m730:Contributi Previdenza Complementare Type
properties	isRef 0 minOcc 0 maxOcc 1 content complex
children	m730:EsclusiDalSostituto m730:NonEsclusiDalSostituto
source	<pre><xs:element name="FondiInSquilibrioFinanziario" type="m730:Contributi_Previdenza_Complementare_Type" minOccurs="0"/></pre>

element Deduzioni_Type/FamiliariACarico

diagram	
namespace	urn:www.agenziaentrate.gov.it:specificheTecniche:sco:730:v1
type	m730:Contributi Previdenza Complementare Type
properties	isRef 0 minOcc 0 maxOcc 1 content complex
children	m730:EsclusiDalSostituto m730:NonEsclusiDalSostituto
source	<pre><xs:element name="FamiliariACarico" type="m730:Contributi_Previdenza_Complementare_Type" minOccurs="0"/></pre>

```
minOccurs="0"/>
```

element **Deduzioni_Type/FondoPensioneDipendentiPubblici**

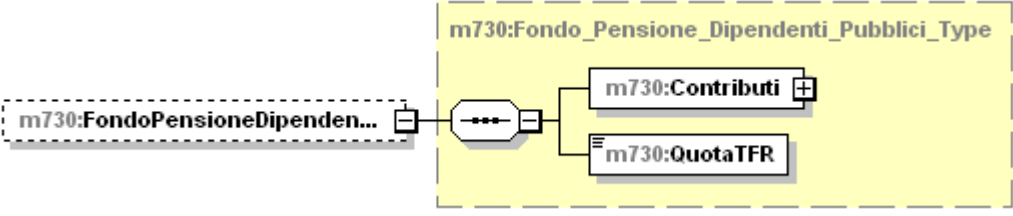
diagram	
namespace	urn:www.agenziaentrate.gov.it:specificheTecniche:sco:730:v1
type	m730:Fondo_Pensione_Dipendenti_Pubblici_Type
properties	isRef 0 minOcc 0 maxOcc 1 content complex
children	m730:Contributi m730:QuotaTFR
source	<pre><xs:element name="FondoPensioneDipendentiPubblici" type="m730:Fondo_Pensione_Dipendenti_Pubblici_Type" minOccurs="0"/></pre>

complexType **Detrazione_Crediti_Type**

<p>diagram</p>	
<p>namespace</p>	<p>urn:www.agenziaentrate.gov.it:specificheTecniche:sco:730:v1</p>
<p>children</p>	<p>m730:DetrazioneConiuge m730:DetrazioneFigli m730:UlterioreDetrazioneFigli m730:DetrazioneFamiliari m730:DetrazioneLavDip m730:DetrazionePens m730:DetrazioneAltriRedditi m730:DetrazioneOneri m730:DetrazioneRistrutturazione m730:DetrazioneRisparmioEnergetico m730:DetrazioneCanoniLocazione m730:AltreDetrazioni m730:DetrazioniSicurezza m730:CreditoPrimaCasa m730:CreditoOccupazione m730:CreditoFondiPensione m730:CreditoMediazioni m730:TotaleDetrazioniCrediti</p>
<p>used by</p>	<p>element Primo Modulo PL Type/DetrazioniCrediti</p>
<p>source</p>	<pre><xs:complexType name="Detrazione_Crediti_Type"> <xs:sequence> <xs:element name="DetrazioneConiuge" type="cm:DatoNP_Type" minOccurs="0"/> <xs:element name="DetrazioneFigli" type="cm:DatoNP_Type" minOccurs="0"/></pre>

```

<xs:element name="UlterioreDetrazioneFigli"
type="cm:DatoNP_Type" minOccurs="0"/>
<xs:element name="DetrazioneFamiliari"
type="cm:DatoNP_Type" minOccurs="0"/>
<xs:element name="DetrazioneLavDip" type="cm:DatoNP_Type"
minOccurs="0"/>
<xs:element name="DetrazionePens" type="cm:DatoNP_Type"
minOccurs="0"/>
<xs:element name="DetrazioneAltriRedditi"
type="cm:DatoNP_Type" minOccurs="0"/>
<xs:element name="DetrazioneOneri" type="cm:DatoNP_Type"
minOccurs="0"/>
<xs:element name="DetrazioneRistrutturazione"
type="cm:DatoNP_Type" minOccurs="0"/>
<xs:element name="DetrazioneRisparmioEnergetico"
type="cm:DatoNP_Type" minOccurs="0"/>
<xs:element name="DetrazioneCanoniLocazione"
type="cm:DatoNP_Type" minOccurs="0"/>
<xs:element name="AltreDetrazioni" type="cm:DatoNP_Type"
minOccurs="0"/>
<xs:element name="DetrazioniSicurezza"
type="cm:DatoNP_Type" minOccurs="0"/>
<xs:element name="CreditoPrimaCasa" type="cm:DatoNP_Type"
minOccurs="0"/>
<xs:element name="CreditoOccupazione"
type="cm:DatoNP_Type" minOccurs="0"/>
<xs:element name="CreditoFondiPensione"
type="cm:DatoNP_Type" minOccurs="0"/>
<xs:element name="CreditoMediazioni"
type="cm:DatoNP_Type" minOccurs="0"/>
<xs:element name="TotaleDetrazioniCrediti"
type="cm:DatoNP_Type" minOccurs="0"/>
</xs:sequence>
</xs:complexType>

```

element **Detrazione_Crediti_Type/DetrazioneConiuge**

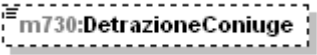
diagram	
namespace	urn:www.agenziaentrate.gov.it:specificheTecniche:sco:730:v1
type	DatoNP_Type
properties	isRef 0 minOcc 0 maxOcc 1 content simple
facets	Kind Value annotation pattern [1-9]{1}[0-9]*

source	<code><xs:element name="DetrazioneConiuge" type="cm:DatoNP_Type" minOccurs="0"/></code>
--------	---

element Detrazione_Crediti_Type/DetrazioneFigli

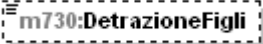
diagram	
namespace	urn:www.agenziaentrate.gov.it:specificheTecniche:sco:730:v1
type	DatoNP_Type
properties	isRef 0 minOcc 0 maxOcc 1 content simple
facets	Kind Value annotation pattern [1-9]{1}[0-9]*
source	<code><xs:element name="DetrazioneFigli" type="cm:DatoNP_Type" minOccurs="0"/></code>

element Detrazione_Crediti_Type/UlterioreDetrazioneFigli

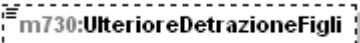
diagram	
namespace	urn:www.agenziaentrate.gov.it:specificheTecniche:sco:730:v1
type	DatoNP_Type
properties	isRef 0 minOcc 0 maxOcc 1 content simple
facets	Kind Value annotation pattern [1-9]{1}[0-9]*
source	<code><xs:element name="UlterioreDetrazioneFigli" type="cm:DatoNP_Type" minOccurs="0"/></code>

element Detrazione_Crediti_Type/DetrazioneFamiliari

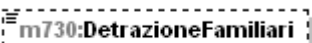
diagram	
namespace	urn:www.agenziaentrate.gov.it:specificheTecniche:sco:730:v1
type	DatoNP_Type
properties	isRef 0 minOcc 0 maxOcc 1 content simple
facets	Kind Value annotation pattern [1-9]{1}[0-9]*
source	<code><xs:element name="DetrazioneFamiliari" type="cm:DatoNP_Type" minOccurs="0"/></code>

element **Detrazione_Crediti_Type/DetrazioneLavDip**

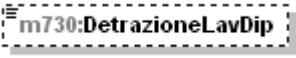
diagram	
namespace	urn:www.agenziaentrate.gov.it:specificheTecniche:sco:730:v1
type	DatoNP_Type
properties	isRef 0 minOcc 0 maxOcc 1 content simple
facets	Kind Value annotation pattern [1-9]{1}[0-9]*
source	<pre><xs:element name="DetrazioneLavDip" type="cm:DatoNP_Type" minOccurs="0"/></pre>

element **Detrazione_Crediti_Type/DetrazionePens**

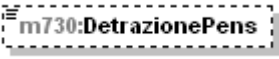
diagram	
namespace	urn:www.agenziaentrate.gov.it:specificheTecniche:sco:730:v1
type	DatoNP_Type
properties	isRef 0 minOcc 0 maxOcc 1 content simple
facets	Kind Value annotation pattern [1-9]{1}[0-9]*
source	<pre><xs:element name="DetrazionePens" type="cm:DatoNP_Type" minOccurs="0"/></pre>

element **Detrazione_Crediti_Type/DetrazioneAltriRedditi**

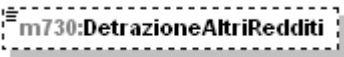
diagram	
namespace	urn:www.agenziaentrate.gov.it:specificheTecniche:sco:730:v1
type	DatoNP_Type
properties	isRef 0 minOcc 0 maxOcc 1 content simple
facets	Kind Value annotation pattern [1-9]{1}[0-9]*
source	<pre><xs:element name="DetrazioneAltriRedditi" type="cm:DatoNP_Type" minOccurs="0"/></pre>

element **Detrazione_Crediti_Type/DetrazioneOneri**

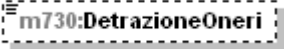
diagram	
namespace	urn:www.agenziaentrate.gov.it:specificheTecniche:sco:730:v1
type	DatoNP_Type
properties	isRef 0 minOcc 0 maxOcc 1 content simple
facets	Kind Value annotation pattern [1-9]{1}[0-9]*
source	<pre><xs:element name="DetrazioneOneri" type="cm:DatoNP_Type" minOccurs="0"/></pre>

element **Detrazione_Crediti_Type/DetrazioneRistrutturazione**

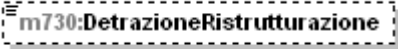
diagram	
namespace	urn:www.agenziaentrate.gov.it:specificheTecniche:sco:730:v1
type	DatoNP_Type
properties	isRef 0 minOcc 0 maxOcc 1 content simple
facets	Kind Value annotation pattern [1-9]{1}[0-9]*
source	<pre><xs:element name="DetrazioneRistrutturazione" type="cm:DatoNP_Type" minOccurs="0"/></pre>

element **Detrazione_Crediti_Type/DetrazioneRisparmioEnergetico**

diagram	
namespace	urn:www.agenziaentrate.gov.it:specificheTecniche:sco:730:v1
type	DatoNP_Type
properties	isRef 0 minOcc 0 maxOcc 1 content simple
facets	Kind Value annotation pattern [1-9]{1}[0-9]*
source	<pre><xs:element name="DetrazioneRisparmioEnergetico" type="cm:DatoNP_Type" minOccurs="0"/></pre>

element **Detrazione_Crediti_Type/DetrazioneCanoniLocazione**

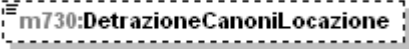
diagram	
namespace	urn:www.agenziaentrate.gov.it:specificheTecniche:sco:730:v1
type	DatoNP_Type
properties	isRef 0 minOcc 0 maxOcc 1 content simple
facets	Kind Value annotation pattern [1-9]{1}[0-9]*
source	<pre><xs:element name="DetrazioneCanoniLocazione" type="cm:DatoNP_Type" minOccurs="0"/></pre>

element **Detrazione_Crediti_Type/AltreDetrazioni**

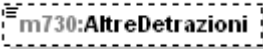
diagram	
namespace	urn:www.agenziaentrate.gov.it:specificheTecniche:sco:730:v1
type	DatoNP_Type
properties	isRef 0 minOcc 0 maxOcc 1 content simple
facets	Kind Value annotation pattern [1-9]{1}[0-9]*
source	<pre><xs:element name="AltreDetrazioni" type="cm:DatoNP_Type" minOccurs="0"/></pre>

element **Detrazione_Crediti_Type/DetrazioniSicurezza**

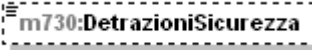
diagram	
namespace	urn:www.agenziaentrate.gov.it:specificheTecniche:sco:730:v1
type	DatoNP_Type
properties	isRef 0 minOcc 0 maxOcc 1 content simple
facets	Kind Value annotation pattern [1-9]{1}[0-9]*
source	<pre><xs:element name="DetrazioniSicurezza" type="cm:DatoNP_Type" minOccurs="0"/></pre>

element **Detrazione_Crediti_Type/CreditoPrimaCasa**

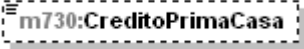
diagram	
namespace	urn:www.agenziaentrate.gov.it:specificheTecniche:sco:730:v1
type	DatoNP_Type
properties	isRef 0 minOcc 0 maxOcc 1 content simple
facets	Kind Value annotation pattern [1-9]{1}[0-9]*
source	<pre><xs:element name="CreditoPrimaCasa" type="cm:DatoNP_Type" minOccurs="0"/></pre>

element **Detrazione_Crediti_Type/CreditoOccupazione**

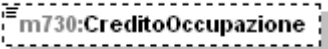
diagram	
namespace	urn:www.agenziaentrate.gov.it:specificheTecniche:sco:730:v1
type	DatoNP_Type
properties	isRef 0 minOcc 0 maxOcc 1 content simple
facets	Kind Value annotation pattern [1-9]{1}[0-9]*
source	<pre><xs:element name="CreditoOccupazione" type="cm:DatoNP_Type" minOccurs="0"/></pre>

element **Detrazione_Crediti_Type/CreditoFondiPensione**

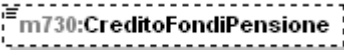
diagram	
namespace	urn:www.agenziaentrate.gov.it:specificheTecniche:sco:730:v1
type	DatoNP_Type
properties	isRef 0 minOcc 0 maxOcc 1 content simple
facets	Kind Value annotation pattern [1-9]{1}[0-9]*
source	<pre><xs:element name="CreditoFondiPensione" type="cm:DatoNP_Type" minOccurs="0"/></pre>

element **Detrazione_Crediti_Type/CreditoMediazioni**

diagram	
namespace	urn:www.agenziaentrate.gov.it:specificheTecniche:sco:730:v1
type	DatoNP_Type
properties	isRef 0 minOcc 0 maxOcc 1 content simple
facets	Kind Value annotation pattern [1-9]{1}[0-9]*
source	<pre><xs:element name="CreditoMediazioni" type="cm:DatoNP_Type" minOccurs="0"/></pre>

element **Detrazione_Crediti_Type/TotaleDetrazioniCrediti**

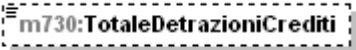
diagram	
namespace	urn:www.agenziaentrate.gov.it:specificheTecniche:sco:730:v1
type	DatoNP_Type
properties	isRef 0 minOcc 0 maxOcc 1 content simple
facets	Kind Value annotation pattern [1-9]{1}[0-9]*
source	<pre><xs:element name="TotaleDetrazioniCrediti" type="cm:DatoNP_Type" minOccurs="0"/></pre>

complexType **Detrazioni_Canoni_Locazione_Type**

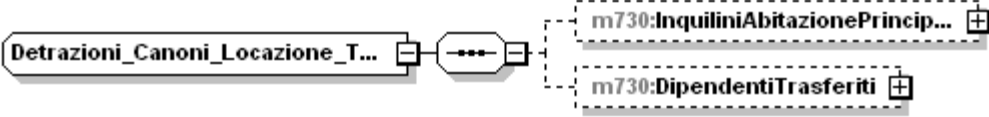
diagram	
namespace	urn:www.agenziaentrate.gov.it:specificheTecniche:sco:730:v1
children	m730:InquiliniAbitazionePrincipale m730:DipendentiTrasferiti
used by	elements PrimoModulo_Oneri_Type/CanoniLocazione Modulo_Oneri_Type/CanoniLocazione
source	<pre><xs:complexType name="Detrazioni_Canoni_Locazione_Type"> <xs:sequence> <xs:element name="InquiliniAbitazionePrincipale" type="m730:Inquilini_Abitazione_Principale_Type" minOccurs="0"/> <xs:element name="DipendentiTrasferiti" type="m730:Giorni_Percentuale_Type" minOccurs="0"/> </xs:sequence> </complexType></pre>

`</xs:complexType>`

element **Detrazioni_Canoni_Locazione_Type/InquiliniAbitazionePrincipale**

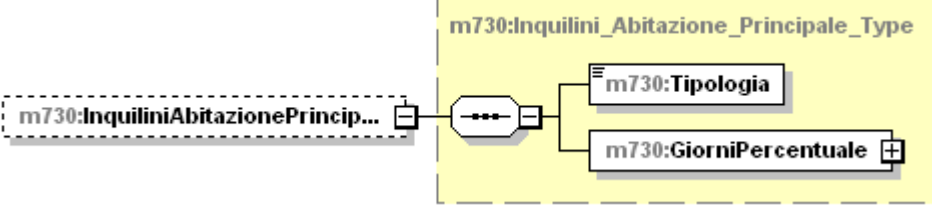
diagram	
namespace	urn:www.agenziaentrate.gov.it:specificheTecniche:sco:730:v1
type	m730:Inquilini_Abitazione_Principale_Type
properties	isRef 0 minOcc 0 maxOcc 1 content complex
children	m730:Tipologia m730:GiorniPercentuale
source	<pre><xs:element name="InquiliniAbitazionePrincipale" type="m730:Inquilini_Abitazione_Principale_Type" minOccurs="0"/></pre>

element **Detrazioni_Canoni_Locazione_Type/DipendentiTrasferiti**

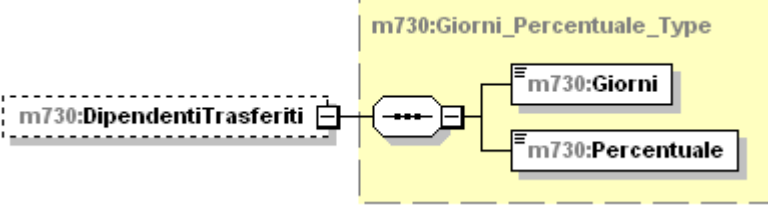
diagram	
namespace	urn:www.agenziaentrate.gov.it:specificheTecniche:sco:730:v1
type	m730:Giorni_Percentuale_Type
properties	isRef 0 minOcc 0 maxOcc 1 content complex
children	m730:Giorni m730:Percentuale
source	<pre><xs:element name="DipendentiTrasferiti" type="m730:Giorni_Percentuale_Type" minOccurs="0"/></pre>

complexType **Detrazioni_Modulo_Type**

diagram	
namespace	urn:www.agenziaentrate.gov.it:specificheTecniche:sco:730:v1
children	m730:VeicoliDisabili m730:AcquistoCaniGuida m730:SpeseRateizzate m730:AttivitaSportiveRagazzi m730:AltreSpese
used by	element Modulo_Oneri_Type/SpeseDetrazioni
source	<pre> <xs:complexType name="Detrazioni_Modulo_Type"> <xs:sequence> <xs:element name="VeicoliDisabili" type="m730:Spese_Rateizzate_Type" minOccurs="0"/> <xs:element name="AcquistoCaniGuida" type="m730:Spese_Rateizzate_Type" minOccurs="0"/> <xs:element name="SpeseRateizzate" type="m730:Spese_Rateizzate_Anni_Precedenti_Type" minOccurs="0"/> <xs:element name="AttivitaSportiveRagazzi" type="cm:DatoNP_Type" minOccurs="0" maxOccurs="2"/> <xs:element name="AltreSpese" type="m730:Altre_Spese_Type" minOccurs="0" maxOccurs="3"/> </xs:sequence> </xs:complexType> </pre>

element **Detrazioni_Modulo_Type/VeicoliDisabili**

diagram	
namespace	urn:www.agenziaentrate.gov.it:specificheTecniche:sco:730:v1
type	m730:Spese_Rateizzate_Type
properties	isRef 0 minOcc 0 maxOcc 1

	content complex
children	m730:Codice m730:Importo
source	<pre><xs:element name="VeicoliDisabili" type="m730:Spese_Rateizzate_Type" minOccurs="0"/></pre>

element **Detrazioni_Modulo_Type/AcquistoCaniGuida**

diagram	
namespace	urn:www.agenziaentrate.gov.it:specificheTecniche:sco:730:v1
type	m730:Spese_Rateizzate_Type
properties	isRef 0 minOcc 0 maxOcc 1 content complex
children	m730:Codice m730:Importo
source	<pre><xs:element name="AcquistoCaniGuida" type="m730:Spese_Rateizzate_Type" minOccurs="0"/></pre>

element **Detrazioni_Modulo_Type/SpeseRateizzate**

diagram	
namespace	urn:www.agenziaentrate.gov.it:specificheTecniche:sco:730:v1
type	m730:Spese_Rateizzate_Anni_Precedenti_Type
properties	isRef 0 minOcc 0 maxOcc 1 content complex
children	m730:Codice m730:Importo
source	<pre><xs:element name="SpeseRateizzate" type="m730:Spese_Rateizzate_Anni_Precedenti_Type" minOccurs="0"/></pre>

element **Detrazioni_Modulo_Type/AttivitaSportiveRagazzi**

diagram	
namespace	urn:www.agenziaentrate.gov.it:specificheTecniche:sco:730:v1
type	DatoNP_Type
properties	isRef 0 minOcc 0 maxOcc 2 content simple
facets	Kind Value annotation pattern [1-9]{1}[0-9]*
source	<pre><xs:element name="AttivitaSportiveRagazzi" type="cm:DatoNP_Type" minOccurs="0" maxOccurs="2"/></pre>

element **Detrazioni_Modulo_Type/AltreSpese**

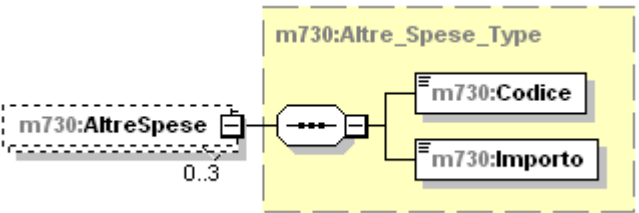
diagram	
namespace	urn:www.agenziaentrate.gov.it:specificheTecniche:sco:730:v1
type	m730:Altre_Spese_Type
properties	isRef 0 minOcc 0 maxOcc 3 content complex
children	m730:Codice m730:Importo
source	<pre><xs:element name="AltreSpese" type="m730:Altre_Spese_Type" minOccurs="0" maxOccurs="3"/></pre>

complexType **Detrazioni_Type**

<p>diagram</p>	
<p>namespace</p>	<p>urn:www.agenziaentrate.gov.it:specificheTecniche:sco:730:v1</p>
<p>children</p>	<p>m730:CasellaVederelIstruzioni m730:SpeseDeterminatePatologie m730:SpeseSanitarie m730:SpeseFamNonACarico m730:SpeseSanitarieDisabili m730:VeicoliDisabili m730:AcquistoCaniGuida m730:SpeseRateizzate m730:MutuiAbPrincipale m730:MutuiAltrilmmobili m730:MutuiRecuperoEdilizio m730:MutuiCostruzioneAbPrincipRecuperoEdilizio m730:MutuiAgrari m730:AssicurazioneVita m730:Istruzione m730:SpeseFunebri m730:AssistenzaPersonale m730:AttivitaSportiveRagazzi m730:AltreSpese</p>
<p>used by</p>	<p>element PrimoModulo_Oneri_Type/SpeseDetrazioni</p>
<p>source</p>	<pre><xs:complexType name="Detrazioni_Type"> <xs:sequence></pre>

```
<xs:element name="CasellaVedereIstruzioni"
type="cm:DatoCB_Type" minOccurs="0"/>
  <xs:element name="SpeseDeterminatePatologie"
type="cm:DatoNP_Type" minOccurs="0"/>
  <xs:element name="SpeseSanitarie" type="cm:DatoNP_Type"
minOccurs="0"/>
  <xs:element name="SpeseFamNonACarico"
type="cm:DatoNP_Type" minOccurs="0"/>
  <xs:element name="SpeseSanitarieDisabili"
type="cm:DatoNP_Type" minOccurs="0"/>
  <xs:element name="VeicoliDisabili"
type="m730:Spese_Rateizzate_Type" minOccurs="0"/>
  <xs:element name="AcquistoCaniGuida"
type="m730:Spese_Rateizzate_Type" minOccurs="0"/>
  <xs:element name="SpeseRateizzate"
type="m730:Spese_Rateizzate_Anni_Precedenti_Type"
minOccurs="0"/>
  <xs:element name="MutuiAbPrincipale"
type="cm:DatoNP_Type" minOccurs="0"/>
  <xs:element name="MutuiAltriImmobili"
type="cm:DatoNP_Type" minOccurs="0"/>
  <xs:element name="MutuiRecuperoEdilizio"
type="cm:DatoNP_Type" minOccurs="0"/>
  <xs:element
name="MutuiCostruzioneAbPrincipRecuperoEdilizio"
type="cm:DatoNP_Type" minOccurs="0"/>
  <xs:element name="MutuiAgrari" type="cm:DatoNP_Type"
minOccurs="0"/>
  <xs:element name="AssicurazioneVita"
type="cm:DatoNP_Type" minOccurs="0"/>
  <xs:element name="Istruzione" type="cm:DatoNP_Type"
minOccurs="0"/>
  <xs:element name="SpeseFunebri" type="cm:DatoNP_Type"
minOccurs="0"/>
  <xs:element name="AssistenzaPersonale"
type="cm:DatoNP_Type" minOccurs="0"/>
  <xs:element name="AttivitaSportiveRagazzi"
type="cm:DatoNP_Type" minOccurs="0" maxOccurs="2"/>
  <xs:element name="AltreSpese"
type="m730:Altre_Spese_Type" minOccurs="0" maxOccurs="3"/>
</xs:sequence>
</xs:complexType>
```

element **Detrazioni_Type/CasellaVedereIstruzioni**

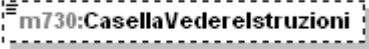
diagram	
namespace	urn:www.agenziaentrate.gov.it:specificheTecniche:sco:730:v1
type	DatoCB_Type
properties	isRef 0 minOcc 0 maxOcc 1 content simple
facets	Kind Value annotation pattern [01]
source	<pre><xs:element name="CasellaVedereIstruzioni" type="cm:DatoCB_Type" minOccurs="0"/></pre>

element **Detrazioni_Type/SpeseDeterminatePatologie**

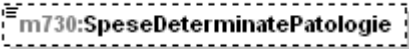
diagram	
namespace	urn:www.agenziaentrate.gov.it:specificheTecniche:sco:730:v1
type	DatoNP_Type
properties	isRef 0 minOcc 0 maxOcc 1 content simple
facets	Kind Value annotation pattern [1-9]{1}[0-9]*
source	<pre><xs:element name="SpeseDeterminatePatologie" type="cm:DatoNP_Type" minOccurs="0"/></pre>

element **Detrazioni_Type/SpeseSanitarie**

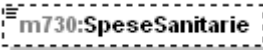
diagram	
namespace	urn:www.agenziaentrate.gov.it:specificheTecniche:sco:730:v1
type	DatoNP_Type
properties	isRef 0 minOcc 0 maxOcc 1 content simple
facets	Kind Value annotation pattern [1-9]{1}[0-9]*
source	<pre><xs:element name="SpeseSanitarie" type="cm:DatoNP_Type" minOccurs="0"/></pre>

element **Detrazioni_Type/SpeseFamNonACarico**

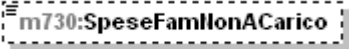
diagram	
namespace	urn:www.agenziaentrate.gov.it:specificheTecniche:sco:730:v1
type	DatoNP_Type
properties	isRef 0 minOcc 0 maxOcc 1 content simple
facets	Kind Value annotation pattern [1-9]{1}[0-9]*
source	<pre><xs:element name="SpeseFamNonACarico" type="cm:DatoNP_Type" minOccurs="0"/></pre>

element **Detrazioni_Type/SpeseSanitarieDisabili**

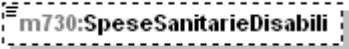
diagram	
namespace	urn:www.agenziaentrate.gov.it:specificheTecniche:sco:730:v1
type	DatoNP_Type
properties	isRef 0 minOcc 0 maxOcc 1 content simple
facets	Kind Value annotation pattern [1-9]{1}[0-9]*
source	<pre><xs:element name="SpeseSanitarieDisabili" type="cm:DatoNP_Type" minOccurs="0"/></pre>

element **Detrazioni_Type/VeicoliDisabili**

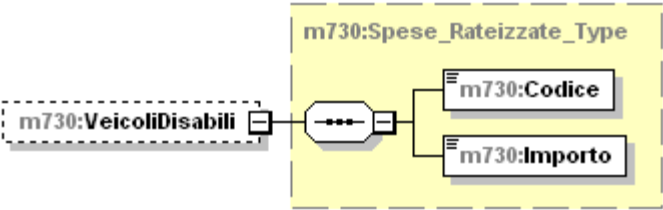
diagram	
namespace	urn:www.agenziaentrate.gov.it:specificheTecniche:sco:730:v1
type	m730:Spese_Rateizzate_Type
properties	isRef 0 minOcc 0 maxOcc 1 content complex
children	m730:Codice m730:Importo
source	<pre><xs:element name="VeicoliDisabili" type="m730:Spese_Rateizzate_Type" minOccurs="0"/></pre>

element **Detrazioni_Type/AcquistoCaniGuida**

diagram	
namespace	urn:www.agenziaentrate.gov.it:specificheTecniche:sco:730:v1
type	m730:Spese_Rateizzate_Type
properties	isRef 0 minOcc 0 maxOcc 1 content complex
children	m730:Codice m730:Importo
source	<pre><xs:element name="AcquistoCaniGuida" type="m730:Spese_Rateizzate_Type" minOccurs="0"/></pre>

element **Detrazioni_Type/SpeseRateizzate**

diagram	
namespace	urn:www.agenziaentrate.gov.it:specificheTecniche:sco:730:v1
type	m730:Spese_Rateizzate_Anni_Precedenti_Type
properties	isRef 0 minOcc 0 maxOcc 1 content complex
children	m730:Codice m730:Importo
source	<pre><xs:element name="SpeseRateizzate" type="m730:Spese_Rateizzate_Anni_Precedenti_Type" minOccurs="0"/></pre>

element **Detrazioni_Type/MutuiAbPrincipale**

diagram	
namespace	urn:www.agenziaentrate.gov.it:specificheTecniche:sco:730:v1
type	DatoNP_Type

properties	isRef 0 minOcc 0 maxOcc 1 content simple
facets	Kind Value annotation pattern [1-9]{1}[0-9]*
source	<code><xs:element name="MutuiAbPrincipale" type="cm:DatoNP_Type" minOccurs="0"/></code>

element Detrazioni_Type/MutuiAltrilmmobili

diagram	
namespace	urn:www.agenziaentrate.gov.it:specificheTecniche:sco:730:v1
type	DatoNP_Type
properties	isRef 0 minOcc 0 maxOcc 1 content simple
facets	Kind Value annotation pattern [1-9]{1}[0-9]*
source	<code><xs:element name="MutuiAltriImmobili" type="cm:DatoNP_Type" minOccurs="0"/></code>

element Detrazioni_Type/MutuiRecuperoEdilizio

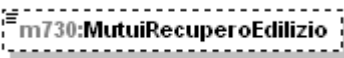
diagram	
namespace	urn:www.agenziaentrate.gov.it:specificheTecniche:sco:730:v1
type	DatoNP_Type
properties	isRef 0 minOcc 0 maxOcc 1 content simple
facets	Kind Value annotation pattern [1-9]{1}[0-9]*
source	<code><xs:element name="MutuiRecuperoEdilizio" type="cm:DatoNP_Type" minOccurs="0"/></code>

element Detrazioni_Type/MutuiCostruzioneAbPrincipRecuperoEdilizio

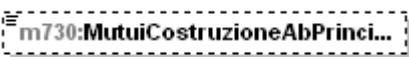
diagram	
namespace	urn:www.agenziaentrate.gov.it:specificheTecniche:sco:730:v1
type	DatoNP_Type
properties	isRef 0 minOcc 0 maxOcc 1

	content simple
facets	Kind Value annotation pattern [1-9]{1}[0-9]*
source	<code><xs:element name="MutuiCostruzioneAbPrincipRecuperoEdilizio" type="cm:DatoNP_Type" minOccurs="0"/></code>

element **Detrazioni_Type/MutuiAgrari**

diagram	
namespace	urn:www.agenziaentrate.gov.it:specificheTecniche:sco:730:v1
type	DatoNP_Type
properties	isRef 0 minOcc 0 maxOcc 1 content simple
facets	Kind Value annotation pattern [1-9]{1}[0-9]*
source	<code><xs:element name="MutuiAgrari" type="cm:DatoNP_Type" minOccurs="0"/></code>

element **Detrazioni_Type/AssicurazioneVita**

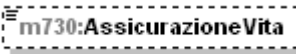
diagram	
namespace	urn:www.agenziaentrate.gov.it:specificheTecniche:sco:730:v1
type	DatoNP_Type
properties	isRef 0 minOcc 0 maxOcc 1 content simple
facets	Kind Value annotation pattern [1-9]{1}[0-9]*
source	<code><xs:element name="AssicurazioneVita" type="cm:DatoNP_Type" minOccurs="0"/></code>

element **Detrazioni_Type/Istruzione**

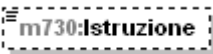
diagram	
namespace	urn:www.agenziaentrate.gov.it:specificheTecniche:sco:730:v1
type	DatoNP_Type
properties	isRef 0 minOcc 0 maxOcc 1 content simple
facets	Kind Value annotation pattern [1-9]{1}[0-9]*

source	<code><xs:element name="Istruzione" type="cm:DatoNP_Type" minOccurs="0"/></code>
--------	--

element Detrazioni_Type/SpeseFunebri

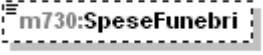
diagram	
namespace	urn:www.agenziaentrate.gov.it:specificheTecniche:sco:730:v1
type	DatoNP_Type
properties	isRef 0 minOcc 0 maxOcc 1 content simple
facets	Kind Value annotation pattern [1-9]{1}[0-9]*
source	<code><xs:element name="SpeseFunebri" type="cm:DatoNP_Type" minOccurs="0"/></code>

element Detrazioni_Type/AssistenzaPersonale

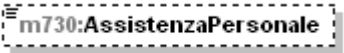
diagram	
namespace	urn:www.agenziaentrate.gov.it:specificheTecniche:sco:730:v1
type	DatoNP_Type
properties	isRef 0 minOcc 0 maxOcc 1 content simple
facets	Kind Value annotation pattern [1-9]{1}[0-9]*
source	<code><xs:element name="AssistenzaPersonale" type="cm:DatoNP_Type" minOccurs="0"/></code>

element Detrazioni_Type/AttivitaSportiveRagazzi

diagram	
namespace	urn:www.agenziaentrate.gov.it:specificheTecniche:sco:730:v1
type	DatoNP_Type
properties	isRef 0 minOcc 0 maxOcc 2 content simple
facets	Kind Value annotation pattern [1-9]{1}[0-9]*
source	<code><xs:element name="AttivitaSportiveRagazzi"</code>

```
type="cm:DatoNP_Type" minOccurs="0" maxOccurs="2"/>
```

element **Detrazioni_Type/AltreSpese**

diagram	
namespace	urn:www.agenziaentrate.gov.it:specificheTecniche:sco:730:v1
type	m730:Altre_Spese_Type
properties	isRef 0 minOcc 0 maxOcc 3 content complex
children	m730:Codice m730:Importo
source	<pre><xs:element name="AltreSpese" type="m730:Altre_Spese_Type" minOccurs="0" maxOccurs="3"/></pre>

complexType **Dichiarazione_Con_Type**

diagram	
namespace	urn:www.agenziaentrate.gov.it:specificheTecniche:sco:730:v1
children	m730:Frontespizio m730:DatiContabili m730:FuoriAssistenzaQuadri m730:Scelte
used by	element Documento_730_Type/DichiarazioneCon
source	<pre><xs:complexType name="Dichiarazione_Con_Type"> <xs:sequence> <xs:element name="Frontespizio" type="m730:Frontespizio_Con_Type"/> <xs:element name="DatiContabili" type="m730:Dati_Contabili_Type"/> <xs:element name="FuoriAssistenzaQuadri" type="m730:Fuori_Assistenza_Type" minOccurs="0"/> <xs:element name="Scelte" type="m730:Scelte_Type" minOccurs="0"/> </xs:sequence> </xs:complexType></pre>

element Dichiarazione_Con_Type/Frontespizio

<p>diagram</p>	
<p>namespace</p>	<p>urn:www.agenziaentrate.gov.it:specificheTecniche:sco:730:v1</p>
<p>type</p>	<p>m730:Frontespizio_Con_Type</p>
<p>properties</p>	<p>isRef 0 content complex</p>
<p>children</p>	<p>m730:SoggettoFiscale m730:DatiAnagrafici m730:ResidenzaAnagrafica m730:DomicilioFiscale01012011 m730:AltriDatiDomicilio m730:Firma m730:StatoCivile</p>
<p>source</p>	<pre><xs:element name="Frontespizio" type="m730:Frontespizio_Con_Type"/></pre>

element **Dichiarazione_Con_Type/DatiContabili**

<p>diagram</p>	
<p>namespace</p>	<p>urn:www.agenziaentrate.gov.it:specificheTecniche:sco:730:v1</p>
<p>type</p>	<p>m730:Dati_Contabili_Type</p>
<p>properties</p>	<p>isRef 0 content complex</p>
<p>children</p>	<p>m730:Familiari m730:QuadroA m730:QuadroB m730:QuadroC m730:QuadroD m730:QuadroE m730:QuadroF m730:QuadroG m730:QuadroI m730:ProspettoLiquidazione m730:Annotazioni</p>
<p>source</p>	<pre><xs:element name="DatiContabili" type="m730:Dati_Contabili_Type"/></pre>

element **Dichiarazione_Con_Type/FuoriAssistenzaQuadri**

diagram	
namespace	urn:www.agenziaentrate.gov.it:specificheTecniche:sco:730:v1
type	m730:Fuori_Assistenza_Type
properties	isRef 0 minOcc 0 maxOcc 1 content complex
children	m730:AnomaliaDatianagrafici m730:AnomaliaTerreni m730:AnomaliaFabbricati m730:AnomaliaLavDip m730:AnomaliaAltriRedditi m730:AnomaliaQuadroF
source	<pre><xs:element name="FuoriAssistenzaQuadri" type="m730:Fuori_Assistenza_Type" minOccurs="0"/></pre>

element **Dichiarazione_Con_Type/Scelte**

diagram	
namespace	urn:www.agenziaentrate.gov.it:specificheTecniche:sco:730:v1
type	m730:Scelte_Type
properties	isRef 0 minOcc 0 maxOcc 1 content complex
children	m730:Scelte8 m730:Scelte5
source	<pre><xs:element name="Scelte" type="m730:Scelte_Type" minOccurs="0"/></pre>

complexType Dichiarazione_Dich_Type

diagram	
namespace	urn:www.agenziaentrate.gov.it:specificheTecniche:sco:730:v1
children	m730:Frontespizio m730:DatiContabili m730:FuoriAssistenza m730:Scelte
used by	element Documento_730_Type/DichiarazioneDich
source	<pre> <xs:complexType name="Dichiarazione_Dich_Type"> <xs:sequence> <xs:element name="Frontespizio"> <xs:complexType> <xs:complexContent> <xs:extension base="m730:Frontespizio_Dich_Type"/> </xs:complexContent> </xs:complexType> </xs:element> <xs:element name="DatiContabili" type="m730:Dati_Contabili_Type"/> <xs:element name="FuoriAssistenza" minOccurs="0"> <xs:complexType> <xs:sequence> <xs:element name="FuoriAssistenzaQuadri" type="m730:Fuori_Assistenza_Type" minOccurs="0"/> <xs:element name="AnomaliaDatiSostituto" type="cm:DatoCB_Type" minOccurs="0"/> <xs:element name="AnomaliaDatiRappresentante" type="cm:DatoCB_Type" minOccurs="0"/> </xs:sequence> </xs:complexType> </xs:element> <xs:element name="Scelte" type="m730:Scelte_Type" minOccurs="0"/> </xs:sequence> </xs:complexType> </pre>

element **Dichiarazione_Dich_Type/Frontespizio**

<p>diagram</p>	
<p>namespace</p>	<p>urn:www.agenziaentrate.gov.it:specificheTecniche:sco:730:v1</p>
<p>type</p>	<p>extension of m730:Frontespizio Dich_Type</p>
<p>properties</p>	<p>isRef 0 content complex</p>
<p>children</p>	<p>m730:SoggettoFiscale m730:DatiAnagrafici m730:ResidenzaAnagrafica m730:DomicilioFiscale01012011 m730:AltriDatiDomicilio m730:Firma m730:StatoCivile m730:Rappresentante</p>
<p>source</p>	<pre><xs:element name="Frontespizio"> <xs:complexType> <xs:complexContent> <xs:extension base="m730:Frontespizio_Dich_Type"/> </xs:complexContent> </xs:complexType> </xs:element></pre>

element **Dichiarazione_Dich_Type/DatiContabili**

diagram	
namespace	urn:www.agenziaentrate.gov.it:specificheTecniche:sco:730:v1
type	m730:Dati_Contabili_Type
properties	isRef 0 content complex
children	m730:Familiari m730:QuadroA m730:QuadroB m730:QuadroC m730:QuadroD m730:QuadroE m730:QuadroF m730:QuadroG m730:QuadroI m730:ProspettoLiquidazione m730:Annotazioni
source	<code><xs:element name="DatiContabili" type="m730:Dati_Contabili_Type"/></code>

element **Dichiarazione_Dich_Type/FuoriAssistenza**

diagram	
namespace	urn:www.agenziaentrate.gov.it:specificheTecniche:sco:730:v1
properties	isRef 0 minOcc 0 maxOcc 1 content complex
children	m730:FuoriAssistenzaQuadri m730:AnomaliaDatiSostituto m730:AnomaliaDatiRappresentante

source	<pre> <xs:element name="FuoriAssistenza" minOccurs="0"> <xs:complexType> <xs:sequence> <xs:element name="FuoriAssistenzaQuadri" type="m730:Fuori_Assistenza_Type" minOccurs="0"/> <xs:element name="AnomaliaDatiSostituto" type="cm:DatoCB_Type" minOccurs="0"/> <xs:element name="AnomaliaDatiRappresentante" type="cm:DatoCB_Type" minOccurs="0"/> </xs:sequence> </xs:complexType> </xs:element> </pre>
--------	--

element **Dichiarazione_Dich_Type/FuoriAssistenza/FuoriAssistenzaQuadri**

diagram	
namespace	urn:www.agenziaentrate.gov.it:specificheTecniche:sco:730:v1
type	m730:Fuori_Assistenza_Type
properties	isRef 0 minOcc 0 maxOcc 1 content complex
children	m730:AnomaliaDatianagrafici m730:AnomaliaTerreni m730:AnomaliaFabbricati m730:AnomaliaLavDip m730:AnomaliaAltriRedditi m730:AnomaliaQuadroF
source	<pre> <xs:element name="FuoriAssistenzaQuadri" type="m730:Fuori_Assistenza_Type" minOccurs="0"/> </pre>

element **Dichiarazione_Dich_Type/FuoriAssistenza/AnomaliaDatiSostituto**

diagram	
namespace	urn:www.agenziaentrate.gov.it:specificheTecniche:sco:730:v1
type	DatoCB_Type

properties	isRef 0 minOcc 0 maxOcc 1 content simple
facets	Kind Value annotation pattern [01]
source	<code><xs:element name="AnomaliaDatiSostituto" type="cm:DatoCB_Type" minOccurs="0"/></code>

element Dichiarazione_Dich_Type/FuoriAssistenza/AnomaliaDatiRappresentante

diagram	
namespace	urn:www.agenziaentrate.gov.it:specificheTecniche:sco:730:v1
type	DatoCB_Type
properties	isRef 0 minOcc 0 maxOcc 1 content simple
facets	Kind Value annotation pattern [01]
source	<code><xs:element name="AnomaliaDatiRappresentante" type="cm:DatoCB_Type" minOccurs="0"/></code>

element Dichiarazione_Dich_Type/Scelte

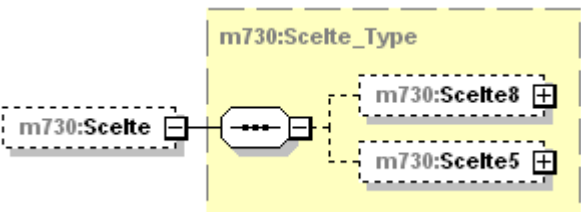
diagram	
namespace	urn:www.agenziaentrate.gov.it:specificheTecniche:sco:730:v1
type	m730:Scelte_Type
properties	isRef 0 minOcc 0 maxOcc 1 content complex
children	m730:Scelte8 m730:Scelte5
source	<code><xs:element name="Scelte" type="m730:Scelte_Type" minOccurs="0"/></code>

```

name="DomicilioUffPeriferico">
    <xs:complexType>
        <xs:complexContent>
            <xs:extension
base="m730:Domicilio_Sogg_Ass_Fiscale_Type">
                <xs:sequence>
                    <xs:element
name="CodiceSedePeriferica" type="cm:DatoAN_Type"
minOccurs="0"/>
                        </xs:sequence>
                    </xs:extension>
                </xs:complexContent>
            </xs:complexType>
        </xs:element>
    </xs:sequence>
</xs:complexType>
</xs:element>
</xs:sequence>
</xs:extension>
</xs:complexContent>
</xs:complexType>
</xs:element>
<xs:element name="DatiProfessionista730-4">
    <xs:complexType>
        <xs:complexContent>
            <xs:extension
base="m730:Dati_Professionista_Type">
                <xs:sequence>
                    <xs:element name="DomicilioProf"
type="m730:Domicilio_Sogg_Ass_Fiscale_Type"/>
                        </xs:sequence>
                    </xs:extension>
                </xs:complexContent>
            </xs:complexType>
        </xs:element>
    <xs:element name="DatiAssociazione730-4">
        <xs:complexType>
            <xs:complexContent>
                <xs:extension
base="m730:Dati_Associazioni_Professionale_Type">
                    <xs:sequence>
                        <xs:element name="DomicilioAssociazione"
type="m730:Domicilio_Sogg_Ass_Fiscale_Type"/>
                            </xs:sequence>
                        </xs:extension>
                    </xs:complexContent>
                </xs:complexType>
            </xs:element>
        </xs:sequence>
    </xs:complexType>
</xs:element>

```

```

        </xs:complexType>
    </xs:element>
</xs:choice>
</xs:complexType>
</xs:element>
<xs:element name="AltriDati" minOccurs="0">
    <xs:complexType>
        <xs:sequence>
            <xs:element name="Rettificativo"
type="cm:DatoCB_Type"/>
            <xs:element name="Integrativo"
type="m730:Integrativo_Type"/>
            <xs:element name="Annullamento"
type="cm:DatoCB_Type"/>
            <xs:element name="SpazioDisposizioneUtente"
type="cm:DatoAN_Type" minOccurs="0"/>
        </xs:sequence>
    </xs:complexType>
</xs:element>
<xs:element name="DatiContabili730-4" minOccurs="0">
    <xs:complexType>
        <xs:choice>
            <xs:element name="Ordinario_730-4">
                <xs:complexType>
                    <xs:sequence>
                        <xs:element name="ImportiTrattenere"
type="m730:ImportiTrattenere730-4"/>
                        <xs:element name="ImportiRimborsare"
type="m730:Importi_Rimborsare730-4_Type"/>
                        <xs:element name="Conguaglio">
                            <xs:complexType>
                                <xs:sequence>
                                    <xs:element name="NumeroRate"
type="cm:DatoN1_Type" minOccurs="0"/>
                                    <xs:choice>
                                        <xs:element name="ImportoRimborsare"
type="cm:DatoNP_Type" minOccurs="0"/>
                                        <xs:element name="ImportoTrattenere"
type="cm:DatoNP_Type" minOccurs="0"/>
                                    </xs:choice>
                                </xs:sequence>
                            </xs:complexType>
                        </xs:element>
                    </xs:sequence>
                </xs:complexType>
            </xs:element>
        </xs:choice>
    </xs:complexType>
</xs:element>
<xs:element name="Integrativo 730-4">

```

```

</xs:sequence>
</xs:element>
</xs:choice>
</xs:complexType>
</xs:element>
</xs:sequence>
</xs:complexType>

```

element Documento_730-4/DatiAnagraficiDichiarante

diagram	
namespace	urn:www.agenziaentrate.gov.it:specificheTecniche:sco:730:v1
type	extension of Dati_Anagrafici_Type
properties	isRef 0 content complex
children	Cognome Nome Sesso DataNascita ComuneNascita ProvinciaNascita m730:CFDichiarante
source	<pre> <xs:element name="DatiAnagraficiDichiarante"> <xs:complexType> <xs:complexContent> <xs:extension base="sc:Dati_Anagrafici_Type"> <xs:sequence> <xs:element name="CFDichiarante" type="cm:DatoCF_Type"/> </xs:sequence> </xs:extension> </xs:complexContent> </xs:complexType> </pre>

```
</xs:complexType>
</xs:element>
```

element **Documento_730-4/DatiAnagraficiDichiarante/CFDichiarante**

diagram	
namespace	urn:www.agenziaentrate.gov.it:specificheTecniche:sco:730:v1
type	DatoCF_Type
properties	isRef 0 content simple
facets	Kind Value pattern [0-9]{11}[A-Z]{6}[0-9LMNPQRSTUVWXYZ]{2}[A-Z]{1}[0-9LMNPQRSTUVWXYZ]{2}[A-Z]{1}[0-9LMNPQRSTUVWXYZ]{3}[A-Z]{1} annotation
source	<code><xs:element name="CFDichiarante" type="cm:DatoCF_Type"/></code>

element **Documento_730-4/Sostituto**

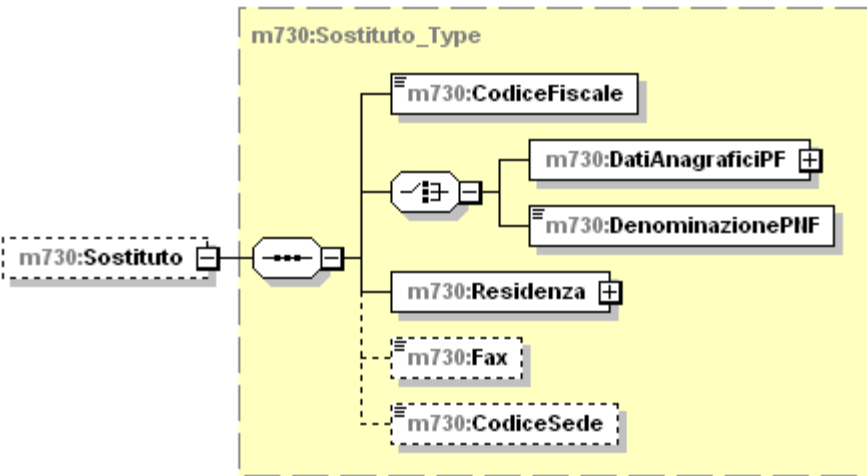
diagram	
namespace	urn:www.agenziaentrate.gov.it:specificheTecniche:sco:730:v1
type	m730:Sostituto_Type
properties	isRef 0 minOcc 0 maxOcc 1 content complex
children	m730:CodiceFiscale m730:DatiAnagraficiPF m730:DenominazionePNF m730:Residenza m730:Fax m730:CodiceSede
source	<code><xs:element name="Sostituto" type="m730:Sostituto_Type" minOccurs="0"/></code>

element Documento_730-4/SoggettoAssFiscale730-4

diagram	
namespace	urn:www.agenziaentrate.gov.it:specificheTecniche:sco:730:v1
properties	isRef 0 content complex
children	m730:DatiCaf730-4 m730:DatiProfessionista730-4 m730:DatiAssociazione730-4
source	<pre> <xs:element name="SoggettoAssFiscale730-4"> <xs:complexType> <xs:choice> <xs:element name="DatiCaf730-4"> <xs:complexType> <xs:complexContent> <xs:extension base="m730:Dati_CAF_Type"> <xs:sequence> <xs:element name="DomicilioCaf" type="m730:Domicilio_Sogg_Ass_Fiscale_Type" minOccurs="0"/> <xs:sequence> <xs:element name="UfficioPerifericoCaf" minOccurs="0"> <xs:complexType> <xs:sequence> <xs:element name="DomicilioUffPeriferico"> <xs:complexType> <xs:complexContent> <xs:extension base="m730:Domicilio_Sogg_Ass_Fiscale_Type"> <xs:sequence> <xs:element name="CodiceSedePeriferica" type="cm:DatoAN_Type" minOccurs="0"/> </xs:sequence> </xs:extension> </xs:complexContent> </xs:complexType> </xs:element> </xs:sequence> </xs:complexType> </xs:element> </xs:sequence> </xs:extension> </xs:complexContent> </xs:complexType> </xs:element> </xs:choice> </xs:complexType> </xs:element> </pre>

```
        </xs:complexContent>
      </xs:complexType>
    </xs:element>
    <xs:element name="DatiProfessionista730-4">
      <xs:complexType>
        <xs:complexContent>
          <xs:extension
base="m730:Dati_Professionista_Type">
            <xs:sequence>
              <xs:element name="DomicilioProf"
type="m730:Domicilio_Sogg_Ass_Fiscale_Type"/>
            </xs:sequence>
          </xs:extension>
        </xs:complexContent>
      </xs:complexType>
    </xs:element>
    <xs:element name="DatiAssociazione730-4">
      <xs:complexType>
        <xs:complexContent>
          <xs:extension
base="m730:Dati_Associazioni_Professionale_Type">
            <xs:sequence>
              <xs:element name="DomicilioAssociazione"
type="m730:Domicilio_Sogg_Ass_Fiscale_Type"/>
            </xs:sequence>
          </xs:extension>
        </xs:complexContent>
      </xs:complexType>
    </xs:element>
  </xs:choice>
</xs:complexType>
</xs:element>
```

element Documento_730-4/SoggettoAssFiscale730-4/DatiCaf730-4

diagram	
namespace	urn:www.agenziaentrate.gov.it:specificheTecniche:sco:730:v1
type	extension of m730:Dati_CAF_Type
properties	isRef 0 content complex
children	m730:CFCaf m730:DenominazioneCaf m730:NumeroAlbo m730:DomicilioCaf m730:UfficioPerifericoCaf
source	<pre> <xs:element name="DatiCaf730-4"> <xs:complexType> <xs:complexContent> <xs:extension base="m730:Dati_CAF_Type"> <xs:sequence> <xs:element name="DomicilioCaf" type="m730:Domicilio_Sogg_Ass_Fiscale_Type" minOccurs="0"/> <xs:sequence> <xs:element name="UfficioPerifericoCaf" minOccurs="0"> <xs:complexType> <xs:sequence> <xs:element name="DomicilioUffPeriferico"> <xs:complexType> <xs:complexContent> <xs:extension base="m730:Domicilio_Sogg_Ass_Fiscale_Type"> <xs:sequence> <xs:element name="CodiceSedePeriferica" type="cm:DatoAN_Type" minOccurs="0"/> </xs:sequence> </xs:extension> </xs:complexContent> </xs:complexType> </xs:element> </xs:sequence> </xs:complexType> </xs:element> </xs:sequence> </xs:extension> </xs:complexContent> </xs:complexType> </xs:element> </pre>

```

        </xs:element>
    </xs:sequence>
</xs:sequence>
</xs:extension>
</xs:complexContent>
</xs:complexType>
</xs:element>

```

element **Documento_730-4/SoggettoAssFiscale730-4/DatiCaf730-4/DomicilioCaf**

diagram	
namespace	urn:www.agenziaentrate.gov.it:specificheTecniche:sco:730:v1
type	m730:Domicilio_Sogg_Ass_Fiscale_Type
properties	isRef 0 minOcc 0 maxOcc 1 content complex
children	m730:Comune m730:Provincia m730:CodiceComune m730:Cap m730:Indirizzo m730:Telefono m730:FAX m730:Email
source	<pre> <xs:element name="DomicilioCaf" type="m730:Domicilio_Sogg_Ass_Fiscale_Type" minOccurs="0"/> </pre>

element **Documento_730-4/SoggettoAssFiscale730-4/DatiCaf730-4/UfficioPerifericoCaf**

diagram	
namespace	urn:www.agenziaentrate.gov.it:specificheTecniche:sco:730:v1
properties	isRef 0 minOcc 0 maxOcc 1 content complex

children	m730:DomicilioUffPeriferico
source	<pre> <xs:element name="UfficioPerifericoCaf" minOccurs="0"> <xs:complexType> <xs:sequence> <xs:element name="DomicilioUffPeriferico"> <xs:complexType> <xs:complexContent> <xs:extension base="m730:Domicilio_Sogg_Ass_Fiscale_Type" type="cm:DatoAN_Type" minOccurs="0"/> </xs:complexContent> </xs:complexType> </xs:element> </xs:sequence> </xs:complexType> </xs:element> </pre>

element **Documento_730-4/SoggettoAssFiscale730-4/DatiCaf730-4/UfficioPerifericoCaf/DomicilioUffPeriferico**

diagram	
namespace	urn:www.agenziaentrate.gov.it:specificheTecniche:sco:730:v1
type	extension of m730:Domicilio_Sogg_Ass_Fiscale_Type

properties	isRef 0 content complex
children	m730:Comune m730:Provincia m730:CodiceComune m730:Cap m730:Indirizzo m730:Telefono m730:FAX m730:Email m730:CodiceSedePeriferica
source	<pre> <xs:element name="DomicilioUffPeriferico"> <xs:complexType> <xs:complexContent> <xs:extension base="m730:Domicilio_Sogg_Ass_Fiscale_Type"> <xs:sequence> <xs:element name="CodiceSedePeriferica" type="cm:DatoAN_Type" minOccurs="0"/> </xs:sequence> </xs:extension> </xs:complexContent> </xs:complexType> </xs:element> </pre>

element **Documento_730-4/SoggettoAssFiscale730-4/DatiCaf730-4/UfficioPerifericoCaf/DomicilioUffPeriferico/CodiceSedePeriferica**

diagram	
namespace	urn:www.agenziaentrategov.it:specificheTecniche:sco:730:v1
type	DatoAN_Type
properties	isRef 0 minOcc 0 maxOcc 1 content simple
facets	Kind Value annotation pattern [0-9A-Z-]{1}([0-9A-Z] \\. & _ \\s / ° \\(\\))*
source	<pre> <xs:element name="CodiceSedePeriferica" type="cm:DatoAN_Type" minOccurs="0"/> </pre>

element **Documento_730-4/SoggettoAssFiscale730-4/DatiProfessionista730-4**

diagram	
namespace	urn:www.agenziaentrategov.it:specificheTecniche:sco:730:v1

type	extension of m730:Dati Professionista Type
properties	isRef 0 content complex
children	m730:CFProfessionista m730:CognomeProfessionista m730:NomeProfessionista m730:DomicilioProf
source	<pre> <xs:element name="DatiProfessionista730-4"> <xs:complexType> <xs:complexContent> <xs:extension base="m730:Dati_Professionista_Type"> <xs:sequence> <xs:element name="DomicilioProf" type="m730:Domicilio_Sogg_Ass_Fiscale_Type"/> </xs:sequence> </xs:extension> </xs:complexContent> </xs:complexType> </xs:element> </pre>

element **Documento_730-4/SoggettoAssFiscale730-4/DatiProfessionista730-4/DomicilioProf**

diagram	
namespace	urn:www.agenziaentrate.gov.it:specificheTecniche:sco:730:v1
type	m730:Domicilio Sogg Ass Fiscale Type
properties	isRef 0 content complex
children	m730:Comune m730:Provincia m730:CodiceComune m730:Cap m730:Indirizzo m730:Telefono m730:FAX m730:Email
source	<pre> <xs:element name="DomicilioProf" type="m730:Domicilio_Sogg_Ass_Fiscale_Type"/> </pre>

element Documento_730-4/SoggettoAssFiscale730-4/DatiAssociazione730-4

diagram	<p>The diagram illustrates the structure of the <code>m730:DatiAssociazione730-4</code> element. It is an extension of the <code>m730:Dati_Associazioni_Professionale_Type</code> (indicated by a dashed box). The structure consists of a sequence of elements: <code>m730:CFAssociazione</code>, <code>m730:DenominazioneAssociazione</code>, <code>m730:CFProfessionista</code>, <code>m730:CognomeProfessionista</code>, <code>m730:NomeProfessionista</code>, and <code>m730:DomicilioAssociazione</code>. The <code>m730:DomicilioAssociazione</code> element is shown with a plus sign, indicating it is a required element.</p>
namespace	urn:www.agenziaentrate.gov.it:specificheTecniche:sco:730:v1
type	extension of m730:Dati_Associazioni_Professionale_Type
properties	isRef 0 content complex
children	m730:CFAssociazione m730:DenominazioneAssociazione m730:CFProfessionista m730:CognomeProfessionista m730:NomeProfessionista m730:DomicilioAssociazione
source	<pre> <xs:element name="DatiAssociazione730-4"> <xs:complexType> <xs:complexContent> <xs:extension base="m730:Dati_Associazioni_Professionale_Type"> <xs:sequence> <xs:element name="DomicilioAssociazione" type="m730:Domicilio_Sogg_Ass_Fiscale_Type"/> </xs:sequence> </xs:extension> </xs:complexContent> </xs:complexType> </xs:element> </pre>

element **Documento_730-4/SoggettoAssFiscale730-4/DatiAssociazione730-4/DomicilioAssociazione**

diagram	
namespace	urn:www.agenziaentrate.gov.it:specificheTecniche:sco:730:v1
type	m730:Domicilio Sogg Ass Fiscale Type
properties	isRef 0 content complex
children	m730:Comune m730:Provincia m730:CodiceComune m730:Cap m730:Indirizzo m730:Telefono m730:FAX m730:Email
source	<pre><xs:element name="DomicilioAssociazione" type="m730:Domicilio_Sogg_Ass_Fiscale_Type"/></pre>

element **Documento_730-4/AltriDati**

diagram	
namespace	urn:www.agenziaentrate.gov.it:specificheTecniche:sco:730:v1
properties	isRef 0 minOcc 0 maxOcc 1 content complex
children	m730:Rettificativo m730:Integrativo m730:Annullamento m730:SpazioDisposizioneUtente
source	<pre><xs:element name="AltriDati" minOccurs="0"> <xs:complexType> <xs:sequence> <xs:element name="Rettificativo" </pre>

	<pre> type="cm:DatoCB_Type"/> <xs:element name="Integrativo" type="m730:Integrativo_Type"/> <xs:element name="Annullamento" type="cm:DatoCB_Type"/> <xs:element name="SpazioDisposizioneUtente" type="cm:DatoAN_Type" minOccurs="0"/> </xs:sequence> </xs:complexType> </xs:element> </pre>
--	--

element Documento_730-4/AltriDati/Rettificativo

diagram	
namespace	urn:www.agenziaentrate.gov.it:specificheTecniche:sco:730:v1
type	DatoCB_Type
properties	isRef 0 content simple
facets	Kind Value annotation pattern [01]
source	<code><xs:element name="Rettificativo" type="cm:DatoCB_Type"/></code>

element Documento_730-4/AltriDati/Integrativo

diagram	
namespace	urn:www.agenziaentrate.gov.it:specificheTecniche:sco:730:v1
type	m730:Integrativo_Type
properties	isRef 0 content simple
facets	Kind Value annotation maxLength 1 pattern [1-9] enumeration 1 enumeration 2 enumeration 3
source	<code><xs:element name="Integrativo" type="m730:Integrativo_Type"/></code>

element Documento_730-4/AltriDati/Annullamento

diagram	
namespace	urn:www.agenziaentrate.gov.it:specificheTecniche:sco:730:v1
type	DatoCB_Type

properties	isRef 0 content simple
facets	Kind Value annotation pattern [01]
source	<code><xs:element name="Annullamento" type="cm:DatoCB_Type"/></code>

element Documento_730-4/AltriDati/SpazioDisposizioneUtente

diagram	
namespace	urn:www.agenziaentrate.gov.it:specificheTecniche:sco:730:v1
type	DatoAN_Type
properties	isRef 0 minOcc 0 maxOcc 1 content simple
facets	Kind Value annotation pattern [0-9A-Z-]{1}([0-9A-Z] \. \- \& _ \/ \° \^ \(\))*
source	<code><xs:element name="SpazioDisposizioneUtente" type="cm:DatoAN_Type" minOccurs="0"/></code>

element Documento_730-4/DatiContabili730-4

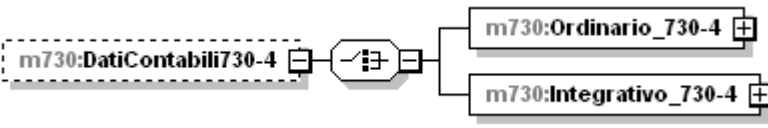
diagram	
namespace	urn:www.agenziaentrate.gov.it:specificheTecniche:sco:730:v1
properties	isRef 0 minOcc 0 maxOcc 1 content complex
children	m730:Ordinario_730-4 m730:Integrativo_730-4
source	<pre><xs:element name="DatiContabili730-4" minOccurs="0"> <xs:complexType> <xs:choice> <xs:element name="Ordinario_730-4"> <xs:complexType> <xs:sequence> <xs:element name="ImportiTrattenere" type="m730:ImportiTrattenere730-4"/> <xs:element name="ImportiRimborsare" type="m730:Importi_Rimborsare730-4_Type"/> <xs:element name="Conguaglio"> <xs:complexType> <xs:sequence> <xs:element name="NumeroRate" type="cm:DatoN1_Type" minOccurs="0"/> </xs:sequence> </xs:complexType> </xs:element> </xs:sequence> </xs:complexType> </xs:element> </xs:choice> </xs:complexType> </xs:element></pre>

```

        <xs:choice>
            <xs:element name="ImportoRimborsare"
type="cm:DatoNP_Type" minOccurs="0"/>
            <xs:element name="ImportoTrattenere"
type="cm:DatoNP_Type" minOccurs="0"/>
        </xs:choice>
    </xs:sequence>
</xs:complexType>
</xs:element>
</xs:sequence>
</xs:complexType>
</xs:element>
<xs:element name="Integrativo_730-4">
    <xs:complexType>
        <xs:sequence>
            <xs:element name="ImportiRimborsare"
type="m730:Importi_Rimborsare730-4_Type"/>
        </xs:sequence>
    </xs:complexType>
</xs:element>
</xs:choice>
</xs:complexType>
</xs:element>

```

element Documento_730-4/DatiContabili730-4/Ordinario_730-4

diagram	
namespace	urn:www.agenziaentrate.gov.it:specificheTecniche:sco:730:v1
properties	isRef 0 content complex
children	m730:ImportiTrattenere m730:ImportiRimborsare m730:Conguaglio
source	<pre> <xs:element name="Ordinario_730-4"> <xs:complexType> <xs:sequence> <xs:element name="ImportiTrattenere" type="m730:ImportiTrattenere730-4"/> <xs:element name="ImportiRimborsare" type="m730:Importi_Rimborsare730-4_Type"/> <xs:element name="Conguaglio"> <xs:complexType> <xs:sequence> <xs:element name="NumeroRate" </pre>

```

type="cm:DatoN1_Type" minOccurs="0"/>
    <xs:choice>
      <xs:element name="ImportoRimborsare"
type="cm:DatoNP_Type" minOccurs="0"/>
      <xs:element name="ImportoTrattenere"
type="cm:DatoNP_Type" minOccurs="0"/>
    </xs:choice>
  </xs:sequence>
</xs:complexType>
</xs:element>
</xs:sequence>
</xs:complexType>
</xs:element>

```

element Documento_730-4/DatiContabili730-4/Ordinario_730-4/ImportiTrattenere

<p>diagram</p>	
<p>namespace</p>	<p>urn:www.agenziaentrate.gov.it:specificheTecniche:sco:730:v1</p>
<p>type</p>	<p>m730:ImportiTrattenere730-4</p>
<p>properties</p>	<p>isRef 0 content complex</p>
<p>children</p>	<p>m730:IrpefTrattenere m730:AddRegTrattenere m730:AddComTrattenere m730:IrpefPrimaRataTrattenere m730:IrpefSecondaRataTrattenere m730:TassSepAccontoTrattene... m730:AddComAccontoTrattene... m730:IncrProduTTrattenere m730:CedolareTrattenere m730:CedolarePrimaRataTratte... m730:CedolareSecondaRataTra... m730:ContribSolidTrattenere</p>

	m730:CedolareSecondaRataTrattenerere m730:ContribSolidTrattenerere
source	<code><xs:element name="ImportiTrattenerere" type="m730:ImportiTrattenerere730-4"/></code>

element [Documento_730-4/DatiContabili730-4/Ordinario_730-4/ImportiRimborsare](#)

diagram	
namespace	urn:www.agenziaentrate.gov.it:specificheTecniche:sco:730:v1
type	m730:Importi_Rimborsare730-4_Type
properties	isRef 0 content complex
children	m730:IrpefRimborsare m730:AddRegRimborsare m730:AddComRimborsare m730:CedolareRimborsare
source	<code><xs:element name="ImportiRimborsare" type="m730:Importi_Rimborsare730-4_Type"/></code>

element [Documento_730-4/DatiContabili730-4/Ordinario_730-4/Conguaglio](#)

diagram	
namespace	urn:www.agenziaentrate.gov.it:specificheTecniche:sco:730:v1
properties	isRef 0 content complex
children	m730:NumeroRate m730:ImportoRimborsare m730:ImportoTrattenerere
source	<pre> <xs:element name="Conguaglio"> <xs:complexType> <xs:sequence> <xs:element name="NumeroRate" type="cm:DatoN1_Type" minOccurs="0"/> <xs:choice> <xs:element name="ImportoRimborsare" type="cm:DatoNP_Type" minOccurs="0"/> <xs:element name="ImportoTrattenerere" </pre>

	<pre> type="cm:DatoNP_Type" minOccurs="0"/> </xs:choice> </xs:sequence> </xs:complexType> </xs:element> </pre>
--	---

element Documento_730-4/DatiContabili730-4/Ordinario_730-4/Conguaglio/NumeroRate

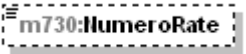
diagram										
namespace	urn:www.agenziaentrate.gov.it:specificheTecniche:sco:730:v1									
type	DatoN1_Type									
properties	<table border="0"> <tr><td>isRef</td><td>0</td></tr> <tr><td>minOcc</td><td>0</td></tr> <tr><td>maxOcc</td><td>1</td></tr> <tr><td>content</td><td>simple</td></tr> </table>	isRef	0	minOcc	0	maxOcc	1	content	simple	
isRef	0									
minOcc	0									
maxOcc	1									
content	simple									
facets	<table border="0"> <tr><td>Kind</td><td>Value</td><td>annotation</td></tr> <tr><td>maxLength</td><td>1</td><td></td></tr> <tr><td>pattern</td><td>[1-9]</td><td></td></tr> </table>	Kind	Value	annotation	maxLength	1		pattern	[1-9]	
Kind	Value	annotation								
maxLength	1									
pattern	[1-9]									
source	<pre> <xs:element name="NumeroRate" type="cm:DatoN1_Type" minOccurs="0"/> </pre>									

element Documento_730-4/DatiContabili730-4/Ordinario_730-4/Conguaglio/ImportoRimborsare

diagram									
namespace	urn:www.agenziaentrate.gov.it:specificheTecniche:sco:730:v1								
type	DatoNP_Type								
properties	<table border="0"> <tr><td>isRef</td><td>0</td></tr> <tr><td>minOcc</td><td>0</td></tr> <tr><td>maxOcc</td><td>1</td></tr> <tr><td>content</td><td>simple</td></tr> </table>	isRef	0	minOcc	0	maxOcc	1	content	simple
isRef	0								
minOcc	0								
maxOcc	1								
content	simple								
facets	<table border="0"> <tr><td>Kind</td><td>Value</td><td>annotation</td></tr> <tr><td>pattern</td><td>[1-9]{1}[0-9]*</td><td></td></tr> </table>	Kind	Value	annotation	pattern	[1-9]{1}[0-9]*			
Kind	Value	annotation							
pattern	[1-9]{1}[0-9]*								
source	<pre> <xs:element name="ImportoRimborsare" type="cm:DatoNP_Type" minOccurs="0"/> </pre>								

element Documento_730-4/DatiContabili730-4/Ordinario_730-4/Conguaglio/ImportoTrattenere

diagram									
namespace	urn:www.agenziaentrate.gov.it:specificheTecniche:sco:730:v1								
type	DatoNP_Type								
properties	<table border="0"> <tr><td>isRef</td><td>0</td></tr> <tr><td>minOcc</td><td>0</td></tr> <tr><td>maxOcc</td><td>1</td></tr> <tr><td>content</td><td>simple</td></tr> </table>	isRef	0	minOcc	0	maxOcc	1	content	simple
isRef	0								
minOcc	0								
maxOcc	1								
content	simple								

facets	Kind pattern	Value [1-9]{1}[0-9]*	annotation
source	<pre><xs:element name="ImportoTrattenere" type="cm:DatoNP_Type" minOccurs="0"/></pre>		

element Documento_730-4/DatiContabili730-4/Integrativo_730-4

diagram	
namespace	urn:www.agenziaentrate.gov.it:specificheTecniche:sco:730:v1
properties	isRef 0 content complex
children	m730:ImportiRimborsare
source	<pre><xs:element name="Integrativo_730-4"> <xs:complexType> <xs:sequence> <xs:element name="ImportiRimborsare" type="m730:Importi_Rimborsare730-4_Type"/> </xs:sequence> </xs:complexType> </xs:element></pre>

element Documento_730-4/DatiContabili730-4/Integrativo_730-4/ImportiRimborsare

diagram	
namespace	urn:www.agenziaentrate.gov.it:specificheTecniche:sco:730:v1
type	m730:Importi_Rimborsare730-4_Type
properties	isRef 0 content complex
children	m730:lrpefRimborsare m730:AddRegRimborsare m730:AddComRimborsare m730:CedolareRimborsare
source	<pre><xs:element name="ImportiRimborsare" type="m730:Importi_Rimborsare730-4_Type"/></pre>

complexType Documento_730_Type

diagram													
namespace	urn:www.agenziaentrate.gov.it:specificheTecniche:sco:730:v1												
type	extension of Documento_Type												
properties	base cm:Documento_Type												
children	m730:DichiarazioneDich m730:DichiarazioneCon m730:AltriDati m730:Sostituto m730:Conguaglio m730:SoggettoAssFiscaleDoc m730:Documento_730-4												
used by	element Fornitura/Documento730												
attributes	<table border="1"> <thead> <tr> <th>Name</th> <th>Type</th> <th>Use</th> <th>Default</th> <th>Fixed</th> <th>annotation</th> </tr> </thead> <tbody> <tr> <td>identificativo</td> <td>Identificativo_Type</td> <td>required</td> <td></td> <td></td> <td></td> </tr> </tbody> </table>	Name	Type	Use	Default	Fixed	annotation	identificativo	Identificativo_Type	required			
Name	Type	Use	Default	Fixed	annotation								
identificativo	Identificativo_Type	required											
source	<pre> <xs:complexType name="Documento_730_Type"> <xs:complexContent> <xs:extension base="cm:Documento_Type"> <xs:sequence> <xs:element name="DichiarazioneDich" type="m730:Dichiarazione_Dich_Type"/> <xs:element name="DichiarazioneCon" type="m730:Dichiarazione_Con_Type" minOccurs="0"/> <xs:element name="AltriDati" minOccurs="0"> <xs:complexType> <xs:sequence> <xs:element name="FlagConferma" type="cm:DatoCB_Type" minOccurs="0"/> <xs:element name="FlagAssenzaDati730-4" type="cm:DatoCB_Type" minOccurs="0"/> <xs:element name="FlagCfErratoDicTrasmessa" type="cm:DatoCB_Type" minOccurs="0"/> </pre>												

```

        <xs:element name="Rettificativo"
type="cm:DatoCB_Type" minOccurs="0"/>
        <xs:element name="Integrativo"
type="m730:Integrativo_Type" minOccurs="0"/>
        <xs:element name="CfProduttoreSoftware"
type="cm:DatoCF_Type" minOccurs="0"/>
        <xs:element name="SpazioDisposizioneUtente"
type="cm:DatoAN_Type" minOccurs="0"/>
        <xs:element name="DichiarazioneCongiunta"
type="cm:DatoCB_Type" minOccurs="0"/>
    </xs:sequence>
</xs:complexType>
</xs:element>
    <xs:element name="Sostituto"
type="m730:Sostituto_Type" minOccurs="0"/>
    <xs:element name="Conguaglio" minOccurs="0">
        <xs:complexType>
            <xs:sequence>
                <xs:element name="ImportoTrattenutoLuglio"
type="cm:DatoNP_Type" minOccurs="0"/>
                <xs:element name="ImportoTrattenutoNovembre"
type="cm:DatoNP_Type" minOccurs="0"/>
                <xs:element name="ImportoRimborsato"
type="cm:DatoNP_Type" minOccurs="0"/>
            </xs:sequence>
        </xs:complexType>
    </xs:element>
    <xs:element name="SoggettoAssFiscaleDoc"
type="m730:Soggetto_Assistenza_FiscaliDoc_type"/>
    <xs:element name="Documento_730-4"
type="m730:Documento_730-4" minOccurs="0"/>
    </xs:sequence>
</xs:extension>
</xs:complexContent>
</xs:complexType>

```

element **Documento_730_Type/DichiarazioneDich**

diagram	
namespace	urn:www.agenziaentrate.gov.it:specificheTecniche:sco:730:v1
type	m730:Dichiarazione_Dich_Type
properties	isRef 0 content complex
children	m730:Frontespizio m730:DatiContabili m730:FuoriAssistenza m730:Scelte
source	<pre><xs:element name="DichiarazioneDich" type="m730:Dichiarazione_Dich_Type"/></pre>

element **Documento_730_Type/DichiarazioneCon**

diagram	
namespace	urn:www.agenziaentrate.gov.it:specificheTecniche:sco:730:v1
type	m730:Dichiarazione_Con_Type
properties	isRef 0 minOcc 0 maxOcc 1 content complex
children	m730:Frontespizio m730:DatiContabili m730:FuoriAssistenzaQuadri m730:Scelte
source	<pre><xs:element name="DichiarazioneCon" type="m730:Dichiarazione_Con_Type" minOccurs="0"/></pre>

element **Documento_730_Type/AltriDati**

<p>diagram</p>	
<p>namespace</p>	<p>urn:www.agenziaentrate.gov.it:specificheTecniche:sco:730:v1</p>
<p>properties</p>	<p>isRef 0 minOcc 0 maxOcc 1 content complex</p>
<p>children</p>	<p>m730:FlagConferma m730:FlagAssenzaDati730-4 m730:FlagCfErratoDicTrasmessa m730:Rettificativo m730:Integrativo m730:CfProduttoreSoftware m730:SpazioDisposizioneUtente m730:DichiarazioneCongiunta</p>
<p>source</p>	<pre><xs:element name="AltriDati" minOccurs="0"> <xs:complexType> <xs:sequence> <xs:element name="FlagConferma" type="cm:DatoCB_Type" minOccurs="0"/> <xs:element name="FlagAssenzaDati730-4" type="cm:DatoCB_Type" minOccurs="0"/> <xs:element name="FlagCfErratoDicTrasmessa" type="cm:DatoCB_Type" minOccurs="0"/> <xs:element name="Rettificativo" type="cm:DatoCB_Type" minOccurs="0"/> <xs:element name="Integrativo" type="m730:Integrativo_Type" minOccurs="0"/> <xs:element name="CfProduttoreSoftware" type="cm:DatoCF_Type" minOccurs="0"/> <xs:element name="SpazioDisposizioneUtente" type="cm:DatoAN_Type" minOccurs="0"/> <xs:element name="DichiarazioneCongiunta" type="cm:DatoCB_Type" minOccurs="0"/> </xs:sequence> </xs:complexType> </xs:element></pre>

element **Documento_730_Type/AltriDati/FlagConferma**

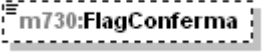
diagram	
namespace	urn:www.agenziaentrate.gov.it:specificheTecniche:sco:730:v1
type	DatoCB_Type
properties	isRef 0 minOcc 0 maxOcc 1 content simple
facets	Kind Value annotation pattern [01]
source	<pre><xs:element name="FlagConferma" type="cm:DatoCB_Type" minOccurs="0"/></pre>

element **Documento_730_Type/AltriDati/FlagAssenzaDati730-4**

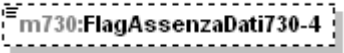
diagram	
namespace	urn:www.agenziaentrate.gov.it:specificheTecniche:sco:730:v1
type	DatoCB_Type
properties	isRef 0 minOcc 0 maxOcc 1 content simple
facets	Kind Value annotation pattern [01]
source	<pre><xs:element name="FlagAssenzaDati730-4" type="cm:DatoCB_Type" minOccurs="0"/></pre>

element **Documento_730_Type/AltriDati/FlagCfErratoDicTrasmessa**

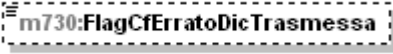
diagram	
namespace	urn:www.agenziaentrate.gov.it:specificheTecniche:sco:730:v1
type	DatoCB_Type
properties	isRef 0 minOcc 0 maxOcc 1 content simple
facets	Kind Value annotation pattern [01]
source	<pre><xs:element name="FlagCfErratoDicTrasmessa" type="cm:DatoCB_Type" minOccurs="0"/></pre>

element **Documento_730_Type/AltriDati/Rettificativo**

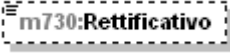
diagram	
namespace	urn:www.agenziaentrate.gov.it:specificheTecniche:sco:730:v1
type	DatoCB_Type
properties	isRef 0 minOcc 0 maxOcc 1 content simple
facets	Kind Value annotation pattern [01]
source	<pre><xs:element name="Rettificativo" type="cm:DatoCB_Type" minOccurs="0"/></pre>

element **Documento_730_Type/AltriDati/Integrativo**

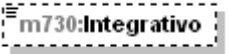
diagram	
namespace	urn:www.agenziaentrate.gov.it:specificheTecniche:sco:730:v1
type	m730:Integrativo_Type
properties	isRef 0 minOcc 0 maxOcc 1 content simple
facets	Kind Value annotation maxLength 1 pattern [1-9] enumeration 1 enumeration 2 enumeration 3
source	<pre><xs:element name="Integrativo" type="m730:Integrativo_Type" minOccurs="0"/></pre>

element **Documento_730_Type/AltriDati/CfProduttoreSoftware**

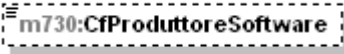
diagram	
namespace	urn:www.agenziaentrate.gov.it:specificheTecniche:sco:730:v1
type	DatoCF_Type
properties	isRef 0 minOcc 0 maxOcc 1 content simple
facets	Kind Value annotation pattern [0-9]{11}[A-Z]{6}[0-9LMNPQRSTUVWXYZ]{2}[A-Z]{1}[0-9LMNPQRSTUVWXYZ]{2}[A-Z]{1}[0-9LMNPQRSTUVWXYZ]{3}[A-Z]{1}
source	<pre><xs:element name="CfProduttoreSoftware" type="cm:DatoCF_Type" minOccurs="0"/></pre>

element Documento_730_Type/AltriDati/SpazioDisposizioneUtente

diagram	
namespace	urn:www.agenziaentrate.gov.it:specificheTecniche:sco:730:v1
type	DatoAN_Type
properties	isRef 0 minOcc 0 maxOcc 1 content simple
facets	Kind Value annotation pattern [0-9A-Z-]{1}([0-9A-Z] \\ \\. & , \\s / ^ \\(\\))*
source	<pre><xs:element name="SpazioDisposizioneUtente" type="cm:DatoAN_Type" minOccurs="0"/></pre>

element Documento_730_Type/AltriDati/DichiarazioneCongiunta

diagram	
namespace	urn:www.agenziaentrate.gov.it:specificheTecniche:sco:730:v1
type	DatoCB_Type
properties	isRef 0 minOcc 0 maxOcc 1 content simple
facets	Kind Value annotation pattern [01]
source	<pre><xs:element name="DichiarazioneCongiunta" type="cm:DatoCB_Type" minOccurs="0"/></pre>

element Documento_730_Type/Sostituto

diagram	
---------	--

namespace	urn:www.agenziaentrate.gov.it:specificheTecniche:sco:730:v1
type	m730:Sostituto_Type
properties	isRef 0 minOcc 0 maxOcc 1 content complex
children	m730:CodiceFiscale m730:DatiAnagraficiPF m730:DenominazionePNF m730:Residenza m730:Fax m730:CodiceSede
source	<pre><xs:element name="Sostituto" type="m730:Sostituto_Type" minOccurs="0"/></pre>

element Documento_730_Type/Conguaglio

diagram	
namespace	urn:www.agenziaentrate.gov.it:specificheTecniche:sco:730:v1
properties	isRef 0 minOcc 0 maxOcc 1 content complex
children	m730:ImportoTrattenutoLuglio m730:ImportoTrattenutoNovembre m730:ImportoRimborsato
source	<pre><xs:element name="Conguaglio" minOccurs="0"> <xs:complexType> <xs:sequence> <xs:element name="ImportoTrattenutoLuglio" type="cm:DatoNP_Type" minOccurs="0"/> <xs:element name="ImportoTrattenutoNovembre" type="cm:DatoNP_Type" minOccurs="0"/> <xs:element name="ImportoRimborsato" type="cm:DatoNP_Type" minOccurs="0"/> </xs:sequence> </xs:complexType> </xs:element></pre>

element Documento_730_Type/Conguaglio/ImportoTrattenutoLuglio

diagram	
namespace	urn:www.agenziaentrate.gov.it:specificheTecniche:sco:730:v1
type	DatoNP_Type
properties	isRef 0 minOcc 0 maxOcc 1 content simple

facets	Kind Value annotation pattern [1-9]{1}[0-9]*
source	<code><xs:element name="ImportoTrattenutoLuglio" type="cm:DatoNP_Type" minOccurs="0"/></code>

element Documento_730_Type/Conguaglio/ImportoTrattenutoNovembre

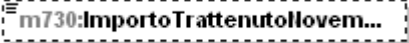
diagram	
namespace	urn:www.agenziaentrate.gov.it:specificheTecniche:sco:730:v1
type	DatoNP_Type
properties	isRef 0 minOcc 0 maxOcc 1 content simple
facets	Kind Value annotation pattern [1-9]{1}[0-9]*
source	<code><xs:element name="ImportoTrattenutoNovembre" type="cm:DatoNP_Type" minOccurs="0"/></code>

element Documento_730_Type/Conguaglio/ImportoRimborsato

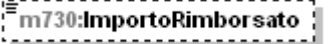
diagram	
namespace	urn:www.agenziaentrate.gov.it:specificheTecniche:sco:730:v1
type	DatoNP_Type
properties	isRef 0 minOcc 0 maxOcc 1 content simple
facets	Kind Value annotation pattern [1-9]{1}[0-9]*
source	<code><xs:element name="ImportoRimborsato" type="cm:DatoNP_Type" minOccurs="0"/></code>

element **Documento_730_Type/SoggettoAssFiscaleDoc**

diagram	
namespace	urn:www.agenziaentrate.gov.it:specificheTecniche:sco:730:v1
type	m730:Soggetto_Assistenza_FiscaliDoc_type
properties	isRef 0 content complex
children	m730:DataConsegna m730:TipologiaSoggettoAssFisc m730:SostitutoCF m730:DatiCafDoc m730:DatiProfessionistaDoc m730:DatiAssociazioneDoc
source	<pre><xs:element name="SoggettoAssFiscaleDoc" type="m730:Soggetto_Assistenza_FiscaliDoc_type"/></pre>

element **Documento_730_Type/Documento_730-4**

diagram	
namespace	urn:www.agenziaentrate.gov.it:specificheTecniche:sco:730:v1
type	m730:Documento_730-4
properties	isRef 0 minOcc 0 maxOcc 1 content complex
children	m730:DatiAnagraficiDichiarante m730:Sostituto m730:SoggettoAssFiscale730-4 m730:AltriDati m730:DatiContabili730-4
source	<pre><xs:element name="Documento_730-4" type="m730:Documento_730-4"/></pre>

4" minOccurs="0"/>

complexType Domicilio_Fiscale_type

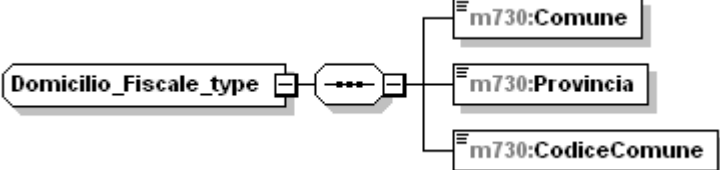
diagram	
namespace	urn:www.agenziaentrate.gov.it:specificheTecniche:sco:730:v1
children	m730:Comune m730:Provincia m730:CodiceComune
used by	elements Frontespizio_730_Type/DomicilioFiscale01012011 Frontespizio_730_Type/AltriDatiDomicilio/DomicilioFiscale01012012 Frontespizio_730_Type/AltriDatiDomicilio/DomicilioFiscale31122011
source	<pre><xs:complexType name="Domicilio_Fiscale_type"> <xs:sequence> <xs:element name="Comune" type="cm:DatoAN_Type"/> <xs:element name="Provincia" type="cm:PR_Type"/> <xs:element name="CodiceComune" type="cm:DatoAN_Type"/> </xs:sequence> </xs:complexType></pre>

element Domicilio_Fiscale_type/Comune

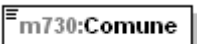
diagram	
namespace	urn:www.agenziaentrate.gov.it:specificheTecniche:sco:730:v1
type	DatoAN_Type
properties	isRef 0 content simple
facets	Kind Value annotation pattern [0-9A-Z-]{1}([0-9A-Z] ' \\. & , \\s / ° \\^ \\(\\))*
source	<pre><xs:element name="Comune" type="cm:DatoAN_Type"/></pre>

element Domicilio_Fiscale_type/Provincia

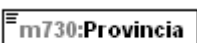
diagram	
namespace	urn:www.agenziaentrate.gov.it:specificheTecniche:sco:730:v1
type	PR_Type
properties	isRef 0 content simple
source	<pre><xs:element name="Provincia" type="cm:PR_Type"/></pre>

element **Domicilio_Fiscale_type/CodiceComune**

diagram	
namespace	urn:www.agenziaentrate.gov.it:specificheTecniche:sco:730:v1
type	DatoAN_Type
properties	isRef 0 content simple
facets	Kind Value pattern [0-9A-Z]{1}([0-9A-Z] \. \& _ \/ ^\ \\) annotation
source	<code><xs:element name="CodiceComune" type="cm:DatoAN_Type"/></code>

complexType **Domicilio_Sogg_Ass_Fiscale_Type**

diagram	
namespace	urn:www.agenziaentrate.gov.it:specificheTecniche:sco:730:v1
children	m730:Comune m730:Provincia m730:CodiceComune m730:Cap m730:Indirizzo m730:Telefono m730:FAX m730:Email
used by	elements Documento 730-4/SoggettoAssFiscale730-4/DatiAssociazione730-4/DomicilioAssociazione Documento 730-4/SoggettoAssFiscale730-4/DatiCaf730-4/DomicilioCaf Documento 730-4/SoggettoAssFiscale730-4/DatiProfessionista730-4/DomicilioProf Documento 730-4/SoggettoAssFiscale730-4/DatiCaf730-4/UfficioPerifericoCaf/DomicilioUffPeriferico
source	<pre><xs:complexType name="Domicilio_Sogg_Ass_Fiscale_Type"> <xs:sequence> <xs:element name="Comune" type="cm:DatoAN_Type"/> <xs:element name="Provincia" type="cm:PR_Type"/> <xs:element name="CodiceComune" type="cm:DatoAN_Type"/> <xs:element name="Cap" type="cm:DatoAN_Type"/> <xs:element name="Indirizzo" type="cm:DatoAN_Type"/> <xs:element name="Telefono" type="cm:DatoAN_Type" minOccurs="0"/> <xs:element name="FAX" type="cm:DatoAN_Type" minOccurs="0"/> </xs:sequence> </xs:complexType></pre>

	<pre> <xs:element name="Email" type="cm:DatoEM_Type" minOccurs="0"/> </xs:sequence> </xs:complexType> </pre>
--	--

element Domicilio_Sogg_Ass_Fiscale_Type/Comune

diagram	
namespace	urn:www.agenziaentrate.gov.it:specificheTecniche:sco:730:v1
type	DatoAN_Type
properties	isRef 0 content simple
facets	Kind Value annotation pattern [0-9A-Z-]{1}([0-9A-Z] \. \& _ \/ \^\ \\)*
source	<pre><xs:element name="Comune" type="cm:DatoAN_Type"/></pre>

element Domicilio_Sogg_Ass_Fiscale_Type/Provincia

diagram	
namespace	urn:www.agenziaentrate.gov.it:specificheTecniche:sco:730:v1
type	PR_Type
properties	isRef 0 content simple
source	<pre><xs:element name="Provincia" type="cm:PR_Type"/></pre>

element Domicilio_Sogg_Ass_Fiscale_Type/CodiceComune

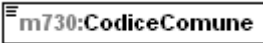
diagram	
namespace	urn:www.agenziaentrate.gov.it:specificheTecniche:sco:730:v1
type	DatoAN_Type
properties	isRef 0 content simple
facets	Kind Value annotation pattern [0-9A-Z-]{1}([0-9A-Z] \. \& _ \/ \^\ \\)*
source	<pre><xs:element name="CodiceComune" type="cm:DatoAN_Type"/></pre>

element Domicilio_Sogg_Ass_Fiscale_Type/Cap

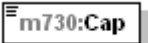
diagram	
namespace	urn:www.agenziaentrate.gov.it:specificheTecniche:sco:730:v1

type	DatoAN_Type
properties	isRef 0 content simple
facets	Kind Value annotation pattern [0-9A-Z-]{1}([0-9A-Z] \\- \\. & _ \\s / ^ \\(\\))*
source	<code><xs:element name="Cap" type="cm:DatoAN_Type"/></code>

element Domicilio_Sogg_Ass_Fiscale_Type/Indirizzo

diagram	
namespace	urn:www.agenziaentrate.gov.it:specificheTecniche:sco:730:v1
type	DatoAN_Type
properties	isRef 0 content simple
facets	Kind Value annotation pattern [0-9A-Z-]{1}([0-9A-Z] \\- \\. & _ \\s / ^ \\(\\))*
source	<code><xs:element name="Indirizzo" type="cm:DatoAN_Type"/></code>

element Domicilio_Sogg_Ass_Fiscale_Type/Telefono

diagram	
namespace	urn:www.agenziaentrate.gov.it:specificheTecniche:sco:730:v1
type	DatoAN_Type
properties	isRef 0 minOcc 0 maxOcc 1 content simple
facets	Kind Value annotation pattern [0-9A-Z-]{1}([0-9A-Z] \\- \\. & _ \\s / ^ \\(\\))*
source	<code><xs:element name="Telefono" type="cm:DatoAN_Type" minOccurs="0"/></code>

element Domicilio_Sogg_Ass_Fiscale_Type/FAX

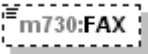
diagram	
namespace	urn:www.agenziaentrate.gov.it:specificheTecniche:sco:730:v1
type	DatoAN_Type
properties	isRef 0 minOcc 0 maxOcc 1 content simple
facets	Kind Value annotation pattern [0-9A-Z-]{1}([0-9A-Z] \\- \\. & _ \\s / ^ \\(\\))*
source	<code><xs:element name="FAX" type="cm:DatoAN_Type" minOccurs="0"/></code>

element **Domicilio_Sogg_Ass_Fiscale_Type/Email**

diagram	
namespace	urn:www.agenziaentrate.gov.it:specificheTecniche:sco:730:v1
type	DatoEM_Type
properties	isRef 0 minOcc 0 maxOcc 1 content simple
facets	Kind Value annotation pattern [a-zA-Z0-9._%\\-]+@[a-zA-Z0-9.\\-]+\\. [a-zA-Z]{2,4}
source	<pre><xs:element name="Email" type="cm:DatoEM_Type" minOccurs="0"/></pre>

complexType **Eccedenze_Type**

diagram	
namespace	urn:www.agenziaentrate.gov.it:specificheTecniche:sco:730:v1
children	m730:Irpef m730:IrpefCompF24 m730:SostitutivaQuadroRT m730:SostitutivaQuadroRTcompF24 m730:CodiceRegione m730:AddRegionaleIrpef m730:AddRegionaleIrpefCompF24 m730:CodiceCatastaleComune m730:AddComunaleIrpef m730:AddComunaleIrpefCompF24
used by	element Primo Modulo Acconti Ritenute Type/Eccedenze
source	<pre><xs:complexType name="Eccedenze_Type"> <xs:sequence> <xs:element name="Irpef" type="cm:DatoNP_Type" minOccurs="0"/> <xs:element name="IrpefCompF24" type="cm:DatoNP_Type"</pre>

```

minOccurs="0"/>
  <xs:element name="SostitutivaQuadroRT"
type="cm:DatoNP_Type" minOccurs="0"/>
  <xs:element name="SostitutivaQuadroRTcompF24"
type="cm:DatoNP_Type" minOccurs="0"/>
  <xs:element name="CodiceRegione"
type="sc:Codice_Regione_Type" minOccurs="0"/>
  <xs:element name="AddRegionaleIrpef"
type="cm:DatoNP_Type" minOccurs="0"/>
  <xs:element name="AddRegionaleIrpefCompF24"
type="cm:DatoNP_Type" minOccurs="0"/>
  <xs:element name="CodiceCatastaleComune" minOccurs="0">
    <xs:simpleType>
      <xs:restriction base="cm:DatoAN_Type">
        <xs:length value="4"/>
      </xs:restriction>
    </xs:simpleType>
  </xs:element>
  <xs:element name="AddComunaleIrpef" type="cm:DatoNP_Type"
minOccurs="0"/>
  <xs:element name="AddComunaleIrpefF24"
type="cm:DatoNP_Type" minOccurs="0"/>
</xs:sequence>
</xs:complexType>

```

element **Eccedenze_Type/Irpef**

diagram	
namespace	urn:www.agenziaentrate.gov.it:specificheTecniche:sco:730:v1
type	DatoNP_Type
properties	isRef 0 minOcc 0 maxOcc 1 content simple
facets	Kind Value annotation pattern [1-9]{1}[0-9]*
source	<pre><xs:element name="Irpef" type="cm:DatoNP_Type" minOccurs="0"/></pre>

element **Eccedenze_Type/IrpefCompF24**

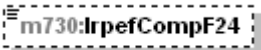
diagram	
namespace	urn:www.agenziaentrate.gov.it:specificheTecniche:sco:730:v1
type	DatoNP_Type

properties	isRef 0 minOcc 0 maxOcc 1 content simple
facets	Kind Value annotation pattern [1-9]{1}[0-9]*
source	<code><xs:element name="IrpefCompF24" type="cm:DatoNP_Type" minOccurs="0"/></code>

element **Eccedenze_Type/SostitutivaQuadroRT**

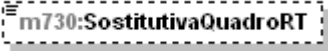
diagram	
namespace	urn:www.agenziaentrate.gov.it:specificheTecniche:sco:730:v1
type	DatoNP_Type
properties	isRef 0 minOcc 0 maxOcc 1 content simple
facets	Kind Value annotation pattern [1-9]{1}[0-9]*
source	<code><xs:element name="SostitutivaQuadroRT" type="cm:DatoNP_Type" minOccurs="0"/></code>

element **Eccedenze_Type/SostitutivaQuadroRTcompF24**

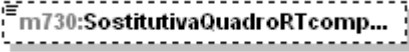
diagram	
namespace	urn:www.agenziaentrate.gov.it:specificheTecniche:sco:730:v1
type	DatoNP_Type
properties	isRef 0 minOcc 0 maxOcc 1 content simple
facets	Kind Value annotation pattern [1-9]{1}[0-9]*
source	<code><xs:element name="SostitutivaQuadroRTcompF24" type="cm:DatoNP_Type" minOccurs="0"/></code>

element **Eccedenze_Type/CodiceRegione**

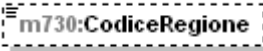
diagram	
namespace	urn:www.agenziaentrate.gov.it:specificheTecniche:sco:730:v1
type	Codice Regione Type
properties	isRef 0 minOcc 0 maxOcc 1

	content	simple	
facets	Kind	Value	annotation
	pattern	[0-9A-Z-]{1}([0-9A-Z] \- \. & _ \\s / ^ \\(\\))*	
	enumeration	1	
	enumeration	2	
	enumeration	3	
	enumeration	4	
	enumeration	5	
	enumeration	6	
	enumeration	7	
	enumeration	8	
	enumeration	9	
	enumeration	10	
	enumeration	11	
	enumeration	12	
	enumeration	13	
	enumeration	14	
	enumeration	15	
	enumeration	16	
	enumeration	17	
	enumeration	18	
	enumeration	19	
	enumeration	20	
enumeration	21		
source	<pre><xs:element name="CodiceRegione" type="sc:Codice_Regione_Type" minOccurs="0"/></pre>		

element **Eccedenze_Type/AddRegionaleIrpef**

diagram	
namespace	urn:www.agenziaentrate.gov.it:specificheTecniche:sco:730:v1
type	DatoNP_Type
properties	isRef 0 minOcc 0 maxOcc 1 content simple
facets	Kind Value annotation pattern [1-9]{1}[0-9]*
source	<pre><xs:element name="AddRegionaleIrpef" type="cm:DatoNP_Type" minOccurs="0"/></pre>

element **Eccedenze_Type/AddRegionaleIrpefCompF24**

diagram	
---------	--

namespace	urn:www.agenziaentrate.gov.it:specificheTecniche:sco:730:v1
type	DatoNP_Type
properties	isRef 0 minOcc 0 maxOcc 1 content simple
facets	Kind Value annotation pattern [1-9]{1}[0-9]*
source	<pre><xs:element name="AddRegionaleIrpefCompF24" type="cm:DatoNP_Type" minOccurs="0"/></pre>

element **Eccedenze_Type/CodiceCatastaleComune**

diagram	
namespace	urn:www.agenziaentrate.gov.it:specificheTecniche:sco:730:v1
type	restriction of DatoAN_Type
properties	isRef 0 minOcc 0 maxOcc 1 content simple
facets	Kind Value annotation length 4 pattern [0-9A-Z-]{1}([0-9A-Z] \. \& , s / ° ^\(\))*
source	<pre><xs:element name="CodiceCatastaleComune" minOccurs="0"> <xs:simpleType> <xs:restriction base="cm:DatoAN_Type"> <xs:length value="4"/> </xs:restriction> </xs:simpleType> </xs:element></pre>

element **Eccedenze_Type/AddComunaleIrpef**

diagram	
namespace	urn:www.agenziaentrate.gov.it:specificheTecniche:sco:730:v1
type	DatoNP_Type
properties	isRef 0 minOcc 0 maxOcc 1 content simple
facets	Kind Value annotation pattern [1-9]{1}[0-9]*
source	<pre><xs:element name="AddComunaleIrpef" type="cm:DatoNP_Type" minOccurs="0"/></pre>

element **Eccedenze_Type/AddComunaleIrpefF24**

diagram	
namespace	urn:www.agenziaentrate.gov.it:specificheTecniche:sco:730:v1
type	DatoNP_Type
properties	isRef 0 minOcc 0 maxOcc 1 content simple
facets	Kind Value annotation pattern [1-9]{1}[0-9]*
source	<pre><xs:element name="AddComunaleIrpefF24" type="cm:DatoNP_Type" minOccurs="0"/></pre>

complexType **Elemento_Integrativo_Type**

diagram	
namespace	urn:www.agenziaentrate.gov.it:specificheTecniche:sco:730:v1
children	m730:Irpef m730:AddizionaleRegionaleIrpef m730:AddComunaleIrpef m730:CedolareSecca
used by	elements Dati_730Integrativo_Type/Credito Dati_730Integrativo_Type/Rimborso
source	<pre><xs:complexType name="Elemento_Integrativo_Type"> <xs:sequence> <xs:element name="Irpef" type="cm:DatoNP_Type" minOccurs="0"/> <xs:element name="AddizionaleRegionaleIrpef" type="cm:DatoNP_Type" minOccurs="0"/> <xs:element name="AddComunaleIrpef" type="cm:DatoNP_Type" minOccurs="0"/> <xs:element name="CedolareSecca" type="cm:DatoNP_Type" minOccurs="0"/> </xs:sequence> </xs:complexType></pre>

element **Elemento_Integrativo_Type/Irpef**

diagram	
namespace	urn:www.agenziaentrate.gov.it:specificheTecniche:sco:730:v1

type	DatoNP_Type
properties	isRef 0 minOcc 0 maxOcc 1 content simple
facets	Kind Value annotation pattern [1-9]{1}[0-9]*
source	<pre><xs:element name="Irpef" type="cm:DatoNP_Type" minOccurs="0"/></pre>

element Elemento_Integrativo_Type/AddizionaleRegionaleIrpef

diagram	
namespace	urn:www.agenziaentrate.gov.it:specificheTecniche:sco:730:v1
type	DatoNP_Type
properties	isRef 0 minOcc 0 maxOcc 1 content simple
facets	Kind Value annotation pattern [1-9]{1}[0-9]*
source	<pre><xs:element name="AddizionaleRegionaleIrpef" type="cm:DatoNP_Type" minOccurs="0"/></pre>

element Elemento_Integrativo_Type/AddComunaleIrpef

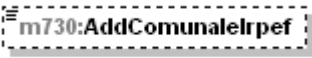
diagram	
namespace	urn:www.agenziaentrate.gov.it:specificheTecniche:sco:730:v1
type	DatoNP_Type
properties	isRef 0 minOcc 0 maxOcc 1 content simple
facets	Kind Value annotation pattern [1-9]{1}[0-9]*
source	<pre><xs:element name="AddComunaleIrpef" type="cm:DatoNP_Type" minOccurs="0"/></pre>

element Elemento_Integrativo_Type/CedolareSecca

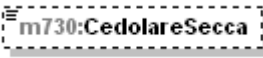
diagram	
namespace	urn:www.agenziaentrate.gov.it:specificheTecniche:sco:730:v1
type	DatoNP_Type
properties	isRef 0 minOcc 0

	maxOcc 1 content simple
facets	Kind Value annotation pattern [1-9]{1}[0-9]*
source	<code><xs:element name="CedolareSecca" type="cm:DatoNP_Type" minOccurs="0"/></code>

complexType **Esenzione_Add_Comunale_Type**

diagram	
namespace	urn:www.agenziaentrate.gov.it:specificheTecniche:sco:730:v1
children	m730:SogliaEsenzioneSaldo m730:SogliaEsenzioneAcconto
used by	element Primo Modulo Acconti Ritenute Type/EsenzioneAddComunale
source	<pre><xs:complexType name="Esenzione_Add_Comunale_Type"> <xs:sequence> <xs:element name="SogliaEsenzioneSaldo" type="m730:Soglie_Esenzione_Type" minOccurs="0"/> <xs:element name="SogliaEsenzioneAcconto" type="m730:Soglie_Esenzione_Type" minOccurs="0"/> </xs:sequence> </xs:complexType></pre>

element **Esenzione_Add_Comunale_Type/SogliaEsenzioneSaldo**

diagram	
namespace	urn:www.agenziaentrate.gov.it:specificheTecniche:sco:730:v1
type	m730:Soglie_Esenzione_Type
properties	isRef 0 minOcc 0 maxOcc 1 content complex
children	m730:SogliaEsenzione m730:EsenzioneTotale m730:AliquotaAgevolata m730:AltreAgevolazioni
source	<code><xs:element name="SogliaEsenzioneSaldo"</code>

```
type="m730:Soglie_Esenzione_Type" minOccurs="0"/>
```

element **Esenzione_Add_Comunale_Type/SogliaEsenzioneAcconto**

diagram	
namespace	urn:www.agenziaentrate.gov.it:specificheTecniche:sco:730:v1
type	m730:Soglie_Esenzione_Type
properties	isRef 0 minOcc 0 maxOcc 1 content complex
children	m730:SogliaEsenzione m730:EsenzioneTotale m730:AliquotaAgevolata m730:AltreAgevolazioni
source	<pre><xs:element name="SogliaEsenzioneAcconto" type="m730:Soglie_Esenzione_Type" minOccurs="0"/></pre>

complexType **Esito_Liquidazione_Type**

diagram	
namespace	urn:www.agenziaentrate.gov.it:specificheTecniche:sco:730:v1
children	m730:Credito m730:Debito
used by	elements Primo Modulo PL Type/LiquidazioneImposte/EsitoAddComunale Primo Modulo PL Type/LiquidazioneImposte/EsitoAddRegionale Primo Modulo PL Type/LiquidazioneImposte/EsitoCedolareSecca Primo Modulo PL Type/LiquidazioneImposte/EsitoIrpel
source	<pre><xs:complexType name="Esito_Liquidazione_Type"> <xs:choice> <xs:element name="Credito" type="m730:Credito_Type"/> <xs:element name="Debito" type="m730:Debito_Type"/> </xs:choice> </xs:complexType></pre>

element **Esito_Liquidazione_Type/Credito**

diagram	
namespace	urn:www.agenziaentrate.gov.it:specificheTecniche:sco:730:v1
type	m730:Credito_Type
properties	isRef 0 content complex
children	m730:NonRimborsabile m730:Credito m730:CreditoF24 m730:CreditoRimborso
source	<code><xs:element name="Credito" type="m730:Credito_Type"/></code>

element **Esito_Liquidazione_Type/Debito**

diagram	
namespace	urn:www.agenziaentrate.gov.it:specificheTecniche:sco:730:v1
type	m730:Debito_Type
properties	isRef 0 content complex
children	m730:NonVersare m730:ImportoDaTrattenere
source	<code><xs:element name="Debito" type="m730:Debito_Type"/></code>

complexType **FabbricatoAgev_Type**

diagram	
---------	--

namespace	urn:www.agenziaentrate.gov.it:specificheTecniche:sco:730:v1
children	m730:NumeroRigoRiferimento m730:NumModuloRiferimento m730:DatiContratto m730:CasellaInf30Giorni m730:AnnoDichiarazioneIci
used by	element Modulo Fabbricato Type/FabbricatoAgev
source	<pre> <xs:complexType name="FabbricatoAgev_Type"> <xs:sequence> <xs:element name="NumeroRigoRiferimento" type="m730:FabbricatoAgev_Numero_Rigo_Type"/> <xs:element name="NumModuloRiferimento" type="cm:DatoNP_Type"/> <xs:choice> <xs:element name="DatiContratto" type="m730:Dati_Contratto_Type"/> <xs:element name="CasellaInf30Giorni" type="cm:DatoCB_Type"/> </xs:choice> <xs:element name="AnnoDichiarazioneIci" type="cm:DatoDA_Type" minOccurs="0"/> </xs:sequence> </xs:complexType> </pre>

element [FabbricatoAgev_Type/NumeroRigoRiferimento](#)

diagram																																					
namespace	urn:www.agenziaentrate.gov.it:specificheTecniche:sco:730:v1																																				
type	m730:FabbricatoAgev_Numero_Rigo_Type																																				
properties	isRef 0 content simple																																				
facets	<table border="1"> <thead> <tr> <th>Kind</th> <th>Value</th> <th>annotation</th> </tr> </thead> <tbody> <tr> <td>pattern</td> <td>[1-9]{1}[0-9]*</td> <td></td> </tr> <tr> <td>enumeration</td> <td>1</td> <td></td> </tr> <tr> <td>enumeration</td> <td>2</td> <td></td> </tr> <tr> <td>enumeration</td> <td>3</td> <td></td> </tr> <tr> <td>enumeration</td> <td>4</td> <td></td> </tr> <tr> <td>enumeration</td> <td>5</td> <td></td> </tr> <tr> <td>enumeration</td> <td>6</td> <td></td> </tr> <tr> <td>enumeration</td> <td>7</td> <td></td> </tr> <tr> <td>enumeration</td> <td>8</td> <td></td> </tr> <tr> <td>enumeration</td> <td>9</td> <td></td> </tr> <tr> <td>enumeration</td> <td>10</td> <td></td> </tr> </tbody> </table>	Kind	Value	annotation	pattern	[1-9]{1}[0-9]*		enumeration	1		enumeration	2		enumeration	3		enumeration	4		enumeration	5		enumeration	6		enumeration	7		enumeration	8		enumeration	9		enumeration	10	
Kind	Value	annotation																																			
pattern	[1-9]{1}[0-9]*																																				
enumeration	1																																				
enumeration	2																																				
enumeration	3																																				
enumeration	4																																				
enumeration	5																																				
enumeration	6																																				
enumeration	7																																				
enumeration	8																																				
enumeration	9																																				
enumeration	10																																				
source	<pre> <xs:element name="NumeroRigoRiferimento" type="m730:FabbricatoAgev_Numero_Rigo_Type"/> </pre>																																				

element **FabbricatoAgev_Type/NumModuloRiferimento**

diagram	
namespace	urn:www.agenziaentrate.gov.it:specificheTecniche:sco:730:v1
type	DatoNP_Type
properties	isRef 0 content simple
facets	Kind Value annotation pattern [1-9]{1}[0-9]*
source	<pre><xs:element name="NumModuloRiferimento" type="cm:DatoNP_Type"/></pre>

element **FabbricatoAgev_Type/DatiContratto**

diagram	
namespace	urn:www.agenziaentrate.gov.it:specificheTecniche:sco:730:v1
type	m730:Dati_Contratto_Type
properties	isRef 0 content complex
children	m730:DataRegContratto m730:SerieContratto m730:NumeroContratto m730:Sottonumero m730:CodiceUfficio
source	<pre><xs:element name="DatiContratto" type="m730:Dati_Contratto_Type"/></pre>

element **FabbricatoAgev_Type/CasellaInf30Giorni**

diagram	
namespace	urn:www.agenziaentrate.gov.it:specificheTecniche:sco:730:v1
type	DatoCB_Type
properties	isRef 0 content simple
facets	Kind Value annotation pattern [01]
source	<pre><xs:element name="CasellaInf30Giorni" type="cm:DatoCB_Type"/></pre>

element **FabbricatoAgev_Type/AnnoDichiarazioneIci**

diagram	
namespace	urn:www.agenziaentrate.gov.it:specificheTecniche:sco:730:v1
type	DatoDA_Type
properties	isRef 0 minOcc 0 maxOcc 1 content simple
facets	Kind Value annotation length 4 pattern (18 19 20)[0-9]{2}
source	<code><xs:element name="AnnoDichiarazioneIci" type="cm:DatoDA_Type" minOccurs="0"/></code>

complexType **FabbricatoOrd_Type**

diagram	
namespace	urn:www.agenziaentrate.gov.it:specificheTecniche:sco:730:v1
children	m730:Rendita m730:Utilizzo m730:GiorniPossesso m730:PercPossesso m730:CodiceCanone m730:CanoneLocazione m730:CasiParticolari m730:CasellaContinuazione m730:CodiceComune m730:IciDovuta m730:OpzioneCedolare
used by	element Modulo Fabbricato_Type/FabbricatoOrd
source	<code><xs:complexType name="FabbricatoOrd_Type"> <xs:sequence></code>

```

<xs:element name="Rendita" type="cm:DatoNP_Type"
minOccurs="0"/>
  <xs:element name="Utilizzo">
    <xs:simpleType>
      <xs:restriction
base="m730:Utilizzo_Fabbricato_Type"/>
    </xs:simpleType>
  </xs:element>
  <xs:element name="GiorniPossesso">
    <xs:simpleType>
      <xs:restriction base="cm:DatoNP_Type">
        <xs:maxLength value="3"/>
      </xs:restriction>
    </xs:simpleType>
  </xs:element>
  <xs:element name="PercPossesso" type="cm:DatoPC_Type"/>
  <xs:element name="CodiceCanone"
type="m730:CodiceCanone_Type" minOccurs="0"/>
  <xs:element name="CanoneLocazione" type="cm:DatoNP_Type"
minOccurs="0"/>
  <xs:element name="CasiParticolari"
type="m730:CasiParticolariFabbricato_Type" minOccurs="0"/>
  <xs:element name="CasellaContinuazione"
type="cm:DatoCB_Type" minOccurs="0"/>
  <xs:element name="CodiceComune" minOccurs="0">
    <xs:simpleType>
      <xs:restriction base="cm:DatoAN_Type">
        <xs:length value="4"/>
      </xs:restriction>
    </xs:simpleType>
  </xs:element>
  <xs:element name="IciDovuta" type="cm:DatoNP_Type"
minOccurs="0"/>
  <xs:element name="OpzioneCedolare" type="cm:DatoCB_Type"
minOccurs="0"/>
</xs:sequence>
</xs:complexType>

```

element **FabbricatoOrd_Type/Rendita**

diagram							
namespace	urn:www.agenziaentrate.gov.it:specificheTecniche:sco:730:v1						
type	DatoNP_Type						
properties	<table> <tr> <td>isRef</td> <td>0</td> </tr> <tr> <td>minOcc</td> <td>0</td> </tr> <tr> <td>maxOcc</td> <td>1</td> </tr> </table>	isRef	0	minOcc	0	maxOcc	1
isRef	0						
minOcc	0						
maxOcc	1						

	content simple						
facets	<table border="1"> <tr> <td>Kind</td> <td>Value</td> <td>annotation</td> </tr> <tr> <td>pattern</td> <td>[1-9]{1}[0-9]*</td> <td></td> </tr> </table>	Kind	Value	annotation	pattern	[1-9]{1}[0-9]*	
Kind	Value	annotation					
pattern	[1-9]{1}[0-9]*						
source	<code><xs:element name="Rendita" type="cm:DatoNP_Type" minOccurs="0"/></code>						

element **FabbricatoOrd_Type/Utilizzo**

diagram																																																										
namespace	urn:www.agenziaentrate.gov.it:specificheTecniche:sco:730:v1																																																									
type	restriction of m730:Utilizzo_Fabbricato_Type																																																									
properties	<table border="1"> <tr> <td>isRef</td> <td>0</td> </tr> <tr> <td>content</td> <td>simple</td> </tr> </table>	isRef	0	content	simple																																																					
isRef	0																																																									
content	simple																																																									
facets	<table border="1"> <tr> <td>Kind</td> <td>Value</td> <td>annotation</td> </tr> <tr> <td>minLength</td> <td>1</td> <td></td> </tr> <tr> <td>maxLength</td> <td>2</td> <td></td> </tr> <tr> <td>pattern</td> <td>[1-9]{1}[0-9]*</td> <td></td> </tr> <tr> <td>enumeration</td> <td>1</td> <td></td> </tr> <tr> <td>enumeration</td> <td>2</td> <td></td> </tr> <tr> <td>enumeration</td> <td>3</td> <td></td> </tr> <tr> <td>enumeration</td> <td>4</td> <td></td> </tr> <tr> <td>enumeration</td> <td>5</td> <td></td> </tr> <tr> <td>enumeration</td> <td>7</td> <td></td> </tr> <tr> <td>enumeration</td> <td>8</td> <td></td> </tr> <tr> <td>enumeration</td> <td>9</td> <td></td> </tr> <tr> <td>enumeration</td> <td>10</td> <td></td> </tr> <tr> <td>enumeration</td> <td>11</td> <td></td> </tr> <tr> <td>enumeration</td> <td>12</td> <td></td> </tr> <tr> <td>enumeration</td> <td>13</td> <td></td> </tr> <tr> <td>enumeration</td> <td>14</td> <td></td> </tr> <tr> <td>enumeration</td> <td>15</td> <td></td> </tr> <tr> <td>enumeration</td> <td>16</td> <td></td> </tr> </table>	Kind	Value	annotation	minLength	1		maxLength	2		pattern	[1-9]{1}[0-9]*		enumeration	1		enumeration	2		enumeration	3		enumeration	4		enumeration	5		enumeration	7		enumeration	8		enumeration	9		enumeration	10		enumeration	11		enumeration	12		enumeration	13		enumeration	14		enumeration	15		enumeration	16	
Kind	Value	annotation																																																								
minLength	1																																																									
maxLength	2																																																									
pattern	[1-9]{1}[0-9]*																																																									
enumeration	1																																																									
enumeration	2																																																									
enumeration	3																																																									
enumeration	4																																																									
enumeration	5																																																									
enumeration	7																																																									
enumeration	8																																																									
enumeration	9																																																									
enumeration	10																																																									
enumeration	11																																																									
enumeration	12																																																									
enumeration	13																																																									
enumeration	14																																																									
enumeration	15																																																									
enumeration	16																																																									
source	<code><xs:element name="Utilizzo"> <xs:simpleType> <xs:restriction base="m730:Utilizzo_Fabbricato_Type"/> </xs:simpleType> </xs:element></code>																																																									

element **FabbricatoOrd_Type/GiorniPossesso**

diagram	
namespace	urn:www.agenziaentrate.gov.it:specificheTecniche:sco:730:v1
type	restriction of DatoNP_Type

properties	isRef 0 content simple
facets	Kind Value annotation maxLength 3 pattern [1-9]{1}[0-9]*
source	<pre><xs:element name="GiorniPossesso"> <xs:simpleType> <xs:restriction base="cm:DatoNP_Type"> <xs:maxLength value="3"/> </xs:restriction> </xs:simpleType> </xs:element></pre>

element **FabbricatoOrd_Type/PercPossesso**

diagram	
namespace	urn:www.agenziaentrate.gov.it:specificheTecniche:sco:730:v1
type	DatoPC_Type
properties	isRef 0 content simple
facets	Kind Value annotation maxLength 16 pattern [0-9]?[0-9](,\d{1,3})? 100(,0{1,3})?
source	<pre><xs:element name="PercPossesso" type="cm:DatoPC_Type"/></pre>

element **FabbricatoOrd_Type/CodiceCanone**

diagram	
namespace	urn:www.agenziaentrate.gov.it:specificheTecniche:sco:730:v1
type	m730:CodiceCanone_Type
properties	isRef 0 minOcc 0 maxOcc 1 content simple
facets	Kind Value annotation maxLength 1 pattern [1-9] enumeration 1 enumeration 2 enumeration 3
source	<pre><xs:element name="CodiceCanone" type="m730:CodiceCanone_Type" minOccurs="0"/></pre>

element **FabbricatoOrd_Type/CanoneLocazione**

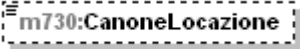
diagram	
namespace	urn:www.agenziaentrate.gov.it:specificheTecniche:sco:730:v1
type	DatoNP_Type
properties	isRef 0 minOcc 0 maxOcc 1 content simple
facets	Kind Value annotation pattern [1-9]{1}[0-9]*
source	<pre><xs:element name="CanoneLocazione" type="cm:DatoNP_Type" minOccurs="0"/></pre>

element **FabbricatoOrd_Type/CasiParticolari**

diagram	
namespace	urn:www.agenziaentrate.gov.it:specificheTecniche:sco:730:v1
type	m730:CasiParticolariFabbricato_Type
properties	isRef 0 minOcc 0 maxOcc 1 content simple
facets	Kind Value annotation maxLength 1 pattern [1-9] enumeration 1 enumeration 3 enumeration 4 enumeration 5 enumeration 6
source	<pre><xs:element name="CasiParticolari" type="m730:CasiParticolariFabbricato_Type" minOccurs="0"/></pre>

element **FabbricatoOrd_Type/CasellaContinuazione**

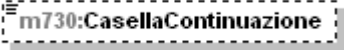
diagram	
namespace	urn:www.agenziaentrate.gov.it:specificheTecniche:sco:730:v1
type	DatoCB_Type
properties	isRef 0 minOcc 0 maxOcc 1 content simple
facets	Kind Value annotation pattern [01]
source	<pre><xs:element name="CasellaContinuazione" type="cm:DatoCB_Type" minOccurs="0"/></pre>

	<code>minOccurs="0"/></code>
--	---------------------------------

element **FabbricatoOrd_Type/CodiceComune**

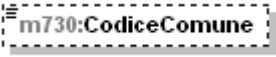
diagram										
namespace	urn:www.agenziaentrate.gov.it:specificheTecniche:sco:730:v1									
type	restriction of DatoAN_Type									
properties	<table border="0"> <tr><td>isRef</td><td>0</td></tr> <tr><td>minOcc</td><td>0</td></tr> <tr><td>maxOcc</td><td>1</td></tr> <tr><td>content</td><td>simple</td></tr> </table>	isRef	0	minOcc	0	maxOcc	1	content	simple	
isRef	0									
minOcc	0									
maxOcc	1									
content	simple									
facets	<table border="0"> <tr><td>Kind</td><td>Value</td><td>annotation</td></tr> <tr><td>length</td><td>4</td><td></td></tr> <tr><td>pattern</td><td colspan="2">[0-9A-Z]{1}([0-9A-Z] \- \. & _ \/ \° \^ \()*)</td></tr> </table>	Kind	Value	annotation	length	4		pattern	[0-9A-Z]{1}([0-9A-Z] \- \. & _ \/ \° \^ \()*)	
Kind	Value	annotation								
length	4									
pattern	[0-9A-Z]{1}([0-9A-Z] \- \. & _ \/ \° \^ \()*)									
source	<pre><xs:element name="CodiceComune" minOccurs="0"> <xs:simpleType> <xs:restriction base="cm:DatoAN_Type"> <xs:length value="4"/> </xs:restriction> </xs:simpleType> </xs:element></pre>									

element **FabbricatoOrd_Type/IciDovuta**

diagram									
namespace	urn:www.agenziaentrate.gov.it:specificheTecniche:sco:730:v1								
type	DatoNP_Type								
properties	<table border="0"> <tr><td>isRef</td><td>0</td></tr> <tr><td>minOcc</td><td>0</td></tr> <tr><td>maxOcc</td><td>1</td></tr> <tr><td>content</td><td>simple</td></tr> </table>	isRef	0	minOcc	0	maxOcc	1	content	simple
isRef	0								
minOcc	0								
maxOcc	1								
content	simple								
facets	<table border="0"> <tr><td>Kind</td><td>Value</td><td>annotation</td></tr> <tr><td>pattern</td><td colspan="2">[1-9]{1}[0-9]*</td></tr> </table>	Kind	Value	annotation	pattern	[1-9]{1}[0-9]*			
Kind	Value	annotation							
pattern	[1-9]{1}[0-9]*								
source	<pre><xs:element name="IciDovuta" type="cm:DatoNP_Type" minOccurs="0"/></pre>								

element **FabbricatoOrd_Type/OpzioneCedolare**

diagram							
namespace	urn:www.agenziaentrate.gov.it:specificheTecniche:sco:730:v1						
type	DatoCB_Type						
properties	<table border="0"> <tr><td>isRef</td><td>0</td></tr> <tr><td>minOcc</td><td>0</td></tr> <tr><td>maxOcc</td><td>1</td></tr> </table>	isRef	0	minOcc	0	maxOcc	1
isRef	0						
minOcc	0						
maxOcc	1						

	content simple
facets	Kind Value annotation pattern [01]
source	<code><xs:element name="OpzioneCedolare" type="cm:DatoCB_Type" minOccurs="0"/></code>

complexType Familiari_PrimoModulo_Type

diagram	
namespace	urn:www.agenziaentrate.gov.it:specificheTecniche:sco:730:v1
children	m730:Coniuge m730:PrimoFiglio m730:Familiari m730:FigliResEsteri m730:PercUlteriore
source	<pre> <xs:complexType name="Familiari_PrimoModulo_Type"> <xs:sequence> <xs:element name="Coniuge" type="m730:Dati_Coniuge_Type" minOccurs="0"/> <xs:element name="PrimoFiglio" minOccurs="0"> <xs:complexType> <xs:complexContent> <xs:extension base="m730:Dati_Familiare_Type"> <xs:sequence> <xs:element name="Tipo"> <xs:simpleType> <xs:restriction base="cm:DatoAN_Type"> <xs:enumeration value="F"/> <xs:enumeration value="D"/> </xs:restriction> </xs:simpleType> </xs:element> </xs:sequence> </xs:extension> </xs:complexContent> </xs:complexType> </xs:element> <xs:element name="Familiari" minOccurs="0" maxOccurs="3"> <xs:complexType> <xs:complexContent> </pre>

```

<xs:extension base="m730:Dati_Familiare_Type">
  <xs:sequence>
    <xs:element name="Tipo">
      <xs:simpleType>
        <xs:restriction base="cm:DatoAN_Type">
          <xs:enumeration value="F"/>
          <xs:enumeration value="D"/>
          <xs:enumeration value="A"/>
        </xs:restriction>
      </xs:simpleType>
    </xs:element>
  </xs:sequence>
</xs:extension>
</xs:complexContent>
</xs:complexType>
</xs:element>
<xs:element name="FigliResEsteri" type="cm:DatoNP_Type"
minOccurs="0"/>
  <xs:element name="PercUlteriore" type="cm:DatoPC_Type"
minOccurs="0"/>
</xs:sequence>
</xs:complexType>

```

element Familiari_PrimoModulo_Type/Coniuge

diagram	
namespace	urn:www.agenziaentrate.gov.it:specificheTecniche:sco:730:v1
type	m730:Dati_Coniuge_Type
properties	isRef 0 minOcc 0 maxOcc 1 content complex
children	m730:Tipo m730:CodiceFiscale m730:Mesi
source	<xs:element name="Coniuge" type="m730:Dati_Coniuge_Type" minOccurs="0"/>

element Familiari_PrimoModulo_Type/PrimoFiglio

<p>diagram</p>	<p>The diagram illustrates the structure of the <code>m730:PrimoFiglio</code> element. It is an extension of <code>m730:Dati_Familiare_Type</code>. The structure is as follows:</p> <ul style="list-style-type: none"> <code>m730:PrimoFiglio</code> (dashed box) is an extension of <code>m730:Dati_Familiare_Type</code> (yellow dashed box). Inside the extension, the elements are: <ul style="list-style-type: none"> <code>m730:CodiceFiscale</code> (dashed box) <code>m730:Mesi</code> (solid box) <code>m730:MesiMinore</code> (dashed box) <code>m730:Affidamento</code> (dashed box) <code>m730:Tipo</code> (solid box), which is further restricted to values 'F' and 'D'.
<p>namespace</p>	<p>urn:www.agenziaentrate.gov.it:specificheTecniche:sco:730:v1</p>
<p>type</p>	<p>extension of m730:Dati_Familiare_Type</p>
<p>properties</p>	<p>isRef 0 minOcc 0 maxOcc 1 content complex</p>
<p>children</p>	<p>m730:CodiceFiscale m730:Mesi m730:MesiMinore m730:PercDetraz m730:PercDetrazCon m730:Affidamento m730:Tipo</p>
<p>source</p>	<pre><xs:element name="PrimoFiglio" minOccurs="0"> <xs:complexType> <xs:complexContent> <xs:extension base="m730:Dati_Familiare_Type"> <xs:sequence> <xs:element name="Tipo"> <xs:simpleType> <xs:restriction base="cm:DatoAN_Type"> <xs:enumeration value="F"/> <xs:enumeration value="D"/> </xs:restriction> </xs:simpleType> </xs:element> </xs:sequence> </xs:extension> </xs:complexContent> </xs:complexType> </xs:element></pre>

element **Familiari_PrimoModulo_Type/PrimoFiglio/Tipo**

diagram	
namespace	urn:www.agenziaentrate.gov.it:specificheTecniche:sco:730:v1
type	restriction of DatoAN_Type
properties	isRef 0 content simple
facets	Kind Value annotation pattern [0-9A-Z-]{1}([0-9A-Z] \\- \\. & \\s / ° \\^ \\(\\))* enumeration F enumeration D
source	<pre><xs:element name="Tipo"> <xs:simpleType> <xs:restriction base="cm:DatoAN_Type"> <xs:enumeration value="F"/> <xs:enumeration value="D"/> </xs:restriction> </xs:simpleType> </xs:element></pre>

element **Familiari_PrimoModulo_Type/Familiari**

diagram	
namespace	urn:www.agenziaentrate.gov.it:specificheTecniche:sco:730:v1
type	extension of m730:Dati_Familiare_Type
properties	isRef 0 minOcc 0 maxOcc 3 content complex
children	m730:CodiceFiscale m730:Mesi m730:MesiMinore m730:PercDetraz m730:PercDetrazCon m730:Affidamento m730:Tipo
source	<pre><xs:element name="Familiari" minOccurs="0" maxOccurs="3"></pre>

	<pre> <xs:complexType> <xs:complexContent> <xs:extension base="m730:Dati_Familiare_Type"> <xs:sequence> <xs:element name="Tipo"> <xs:simpleType> <xs:restriction base="cm:DatoAN_Type"> <xs:enumeration value="F"/> <xs:enumeration value="D"/> <xs:enumeration value="A"/> </xs:restriction> </xs:simpleType> </xs:element> </xs:sequence> </xs:extension> </xs:complexContent> </xs:complexType> </xs:element> </pre>
--	---

element Familiari_PrimoModulo_Type/Familiari/Tipo

diagram																
namespace	urn:www.agenziaentrate.gov.it:specificheTecniche:sco:730:v1															
type	restriction of DatoAN_Type															
properties	isRef 0 content simple															
facets	<table border="0"> <tr> <td>Kind</td> <td>Value</td> <td>annotation</td> </tr> <tr> <td>pattern</td> <td>[0-9A-Z-]{1}([0-9A-Z] \\- \\. &amp; ; \\s / ° \\^ \\(\\))*</td> <td></td> </tr> <tr> <td>enumeration</td> <td>F</td> <td></td> </tr> <tr> <td>enumeration</td> <td>D</td> <td></td> </tr> <tr> <td>enumeration</td> <td>A</td> <td></td> </tr> </table>	Kind	Value	annotation	pattern	[0-9A-Z-]{1}([0-9A-Z] \\- \\. & ; \\s / ° \\^ \\(\\))*		enumeration	F		enumeration	D		enumeration	A	
Kind	Value	annotation														
pattern	[0-9A-Z-]{1}([0-9A-Z] \\- \\. & ; \\s / ° \\^ \\(\\))*															
enumeration	F															
enumeration	D															
enumeration	A															
source	<pre> <xs:element name="Tipo"> <xs:simpleType> <xs:restriction base="cm:DatoAN_Type"> <xs:enumeration value="F"/> <xs:enumeration value="D"/> <xs:enumeration value="A"/> </xs:restriction> </xs:simpleType> </xs:element> </pre>															

element Familiari_PrimoModulo_Type/FigliResEsteri

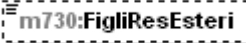
diagram	
---------	---

namespace	urn:www.agenziaentrate.gov.it:specificheTecniche:sco:730:v1
type	DatoNP_Type
properties	isRef 0 minOcc 0 maxOcc 1 content simple
facets	Kind Value annotation pattern [1-9]{1}[0-9]*
source	<pre><xs:element name="FigliResEsteri" type="cm:DatoNP_Type" minOccurs="0"/></pre>

element Familiari_PrimoModulo_Type/PercUlteriore

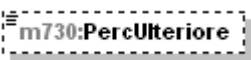
diagram	
namespace	urn:www.agenziaentrate.gov.it:specificheTecniche:sco:730:v1
type	DatoPC_Type
properties	isRef 0 minOcc 0 maxOcc 1 content simple
facets	Kind Value annotation maxLength 16 pattern [0-9]?[0-9](\d{1,3})? 100,(0{1,3})?
source	<pre><xs:element name="PercUlteriore" type="cm:DatoPC_Type" minOccurs="0"/></pre>

complexType Familiari_Type

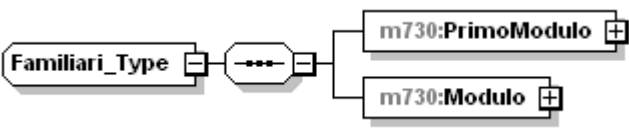
diagram	
namespace	urn:www.agenziaentrate.gov.it:specificheTecniche:sco:730:v1
children	m730:PrimoModulo m730:Modulo
used by	element Dati Contabili Type/Familiari
source	<pre><xs:complexType name="Familiari_Type"> <xs:sequence> <xs:element name="PrimoModulo"> <xs:complexType> <xs:complexContent> <xs:extension base="m730:Modulo_Familiari_Type"> <xs:sequence> <xs:element name="FigliResEsteri" type="cm:DatoNP_Type" minOccurs="0"/> <xs:element name="PercUlteriore"</pre>

```

type="cm:DatoPC_Type" minOccurs="0"/>
    </xs:sequence>
  </xs:extension>
</xs:complexContent>
</xs:complexType>
</xs:element>
<xs:element name="Modulo"
type="m730:Modulo_Familiari_Type"/>
</xs:sequence>
</xs:complexType>

```

element **Familiari_Type/PrimoModulo**

diagram	
namespace	urn:www.agenziaentrate.gov.it:specificheTecniche:sco:730:v1
type	extension of m730:Modulo_Familiari_Type
properties	isRef 0 content complex
children	m730:Coniuge m730:PrimoFiglio m730:Familiari m730:FigliResEsteri m730:PercUlteriore
source	<pre> <xs:element name="PrimoModulo"> <xs:complexType> <xs:complexContent> <xs:extension base="m730:Modulo_Familiari_Type"> <xs:sequence> <xs:element name="FigliResEsteri" type="cm:DatoNP_Type" minOccurs="0"/> <xs:element name="PercUlteriore" type="cm:DatoPC_Type" minOccurs="0"/> </xs:sequence> </xs:extension> </xs:complexContent> </xs:complexType> </xs:element> </pre>

element **Familiari_Type/PrimoModulo/FigliResEsteri**

diagram	
namespace	urn:www.agenziaentrate.gov.it:specificheTecniche:sco:730:v1
type	DatoNP_Type
properties	isRef 0 minOcc 0 maxOcc 1 content simple
facets	Kind Value annotation pattern [1-9]{1}[0-9]*
source	<pre><xs:element name="FigliResEsteri" type="cm:DatoNP_Type" minOccurs="0"/></pre>

element **Familiari_Type/PrimoModulo/PercUlteriore**

diagram	
namespace	urn:www.agenziaentrate.gov.it:specificheTecniche:sco:730:v1
type	DatoPC_Type
properties	isRef 0 minOcc 0 maxOcc 1 content simple
facets	Kind Value annotation maxLength 16 pattern [0-9]?[0-9](,\d{1,3})? 100(,0{1,3})?
source	<pre><xs:element name="PercUlteriore" type="cm:DatoPC_Type" minOccurs="0"/></pre>

element **Familiari_Type/Modulo**

diagram	
namespace	urn:www.agenziaentrate.gov.it:specificheTecniche:sco:730:v1
type	m730:Modulo_Familiari_Type
properties	isRef 0 content complex
children	m730:Coniuge m730:PrimoFiglio m730:Familiari

source	<code><xs:element name="Modulo" type="m730:Modulo_Familiari_Type"/></code>
--------	--

complexType Firma_Dichiarazione_Type

diagram	
namespace	urn:www.agenziaentrate.gov.it:specificheTecniche:sco:730:v1
children	m730:NumeroModelli m730:FirmaDichiarazione m730:OpzioneInformativa m730:SoggettoFiscalmenteCarico
used by	element Frontespizio_730_Type/Firma
source	<pre> <xs:complexType name="Firma_Dichiarazione_Type"> <xs:sequence> <xs:element name="NumeroModelli" type="cm:DatoNP_Type"/> <xs:element name="FirmaDichiarazione" type="cm:DatoCB_Type"/> <xs:element name="OpzioneInformativa" type="cm:DatoCB_Type" minOccurs="0"/> <xs:element name="SoggettoFiscalmenteCarico" type="cm:DatoCB_Type" minOccurs="0"/> </xs:sequence> </xs:complexType> </pre>

element Firma_Dichiarazione_Type/NumeroModelli

diagram	
namespace	urn:www.agenziaentrate.gov.it:specificheTecniche:sco:730:v1
type	DatoNP_Type
properties	isRef 0 content simple
facets	Kind Value annotation pattern [1-9]{1}[0-9]*
source	<code><xs:element name="NumeroModelli" type="cm:DatoNP_Type"/></code>

element Firma_Dichiarazione_Type/FirmaDichiarazione

diagram	
namespace	urn:www.agenziaentrate.gov.it:specificheTecniche:sco:730:v1

type	DatoCB_Type
properties	isRef 0 content simple
facets	Kind Value annotation pattern [01]
source	<code><xs:element name="FirmaDichiarazione" type="cm:DatoCB_Type"/></code>

element Firma_Dichiarazione_Type/OpzioneInformativa

diagram	
namespace	urn:www.agenziaentrate.gov.it:specificheTecniche:sco:730:v1
type	DatoCB_Type
properties	isRef 0 minOcc 0 maxOcc 1 content simple
facets	Kind Value annotation pattern [01]
source	<code><xs:element name="OpzioneInformativa" type="cm:DatoCB_Type" minOccurs="0"/></code>

element Firma_Dichiarazione_Type/SoggettoFiscalmenteCarico

diagram	
namespace	urn:www.agenziaentrate.gov.it:specificheTecniche:sco:730:v1
type	DatoCB_Type
properties	isRef 0 minOcc 0 maxOcc 1 content simple
facets	Kind Value annotation pattern [01]
source	<code><xs:element name="SoggettoFiscalmenteCarico" type="cm:DatoCB_Type" minOccurs="0"/></code>

complexType Fondo_Pensione_Dipendenti_Pubblici_Type

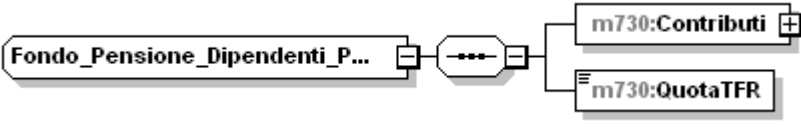
diagram	
namespace	urn:www.agenziaentrate.gov.it:specificheTecniche:sco:730:v1
children	m730:Contributi m730:QuotaTFR
used by	element Deduzioni_Type/FondoPensioneDipendentiPubblici

source	<pre><xs:complexType name="Fondo_Pensione_Dipendenti_Pubblici_Type"> <xs:sequence> <xs:element name="Contributi" type="m730:Contributi_Previdenza_Complementare_Type"/> <xs:element name="QuotaTFR" type="cm:DatoNP_Type"/> </xs:sequence> </xs:complexType></pre>
--------	--

element Fondo_Pensione_Dipendenti_Pubblici_Type/Contributi

diagram	<pre> classDiagram class m730Contributi["m730:Contributi"] class m730EsclusiDalSostituto["m730:EsclusiDalSostituto"] class m730NonEsclusiDalSostituto["m730:NonEsclusiDalSostituto"] m730Contributi "1" -- "*" m730EsclusiDalSostituto m730Contributi "1" -- "*" m730NonEsclusiDalSostituto </pre>
namespace	urn:www.agenziaentrate.gov.it:specificheTecniche:sco:730:v1
type	m730:Contributi_Previdenza_Complementare_Type
properties	isRef 0 content complex
children	m730:EsclusiDalSostituto m730:NonEsclusiDalSostituto
source	<pre><xs:element name="Contributi" type="m730:Contributi_Previdenza_Complementare_Type"/></pre>

element Fondo_Pensione_Dipendenti_Pubblici_Type/QuotaTFR

diagram	<pre> classDiagram class m730QuotaTFR["m730:QuotaTFR"] </pre>
namespace	urn:www.agenziaentrate.gov.it:specificheTecniche:sco:730:v1
type	DatoNP_Type
properties	isRef 0 content simple
facets	Kind Value annotation pattern [1-9]{1}[0-9]*
source	<pre><xs:element name="QuotaTFR" type="cm:DatoNP_Type"/></pre>

complexType **Frontespizio_730_Type**

diagram	
namespace	urn:www.agenziaentrate.gov.it:specificheTecniche:sco:730:v1
children	m730:SoggettoFiscale m730:DatiAnagrafici m730:ResidenzaAnagrafica m730:DomicilioFiscale01012011 m730:AltriDatiDomicilio m730:Firma
used by	complexTypes Frontespizio Con Type Frontespizio Dich Type
source	<pre> <xs:complexType name="Frontespizio_730_Type"> <xs:sequence> <xs:element name="SoggettoFiscale" type="m730:Soggetto_Fiscale_730_Type"/> <xs:element name="DatiAnagrafici" type="sc:Dati_Anagrafici_Type"/> <xs:element name="ResidenzaAnagrafica" type="m730:Residenza_Anagrafica_730_Type" minOccurs="0"/> <xs:element name="DomicilioFiscale01012011" type="m730:Domicilio_Fiscale_type"/> <xs:element name="AltriDatiDomicilio" minOccurs="0"> <xs:complexType> <xs:sequence> <xs:element name="DomicilioFiscale31122011" type="m730:Domicilio_Fiscale_type"/> <xs:element name="DomicilioFiscale01012012" type="m730:Domicilio_Fiscale_type"/> </xs:sequence> </xs:complexType> </xs:element> <xs:element name="Firma" type="m730:Firma_Dichiarazione_Type"/> </xs:sequence> </xs:complexType> </pre>

element **Frontespizio_730_Type/SoggettoFiscale**

diagram	<p>The diagram illustrates the structure of the <code>m730:SoggettoFiscale</code> element. It is a complex type containing four child elements: <code>m730:CodiceFiscale</code>, <code>m730:Email</code>, <code>m730:Telefono</code>, and <code>m730:Cellulare</code>. The <code>m730:CodiceFiscale</code> element is shown as a solid box, while the others are shown as dashed boxes. The entire structure is enclosed in a dashed box labeled <code>m730:Soggetto_Fiscale_730_Type</code>.</p>
namespace	urn:www.agenziaentrate.gov.it:specificheTecniche:sco:730:v1
type	m730:Soggetto_Fiscale_730_Type
properties	isRef 0 content complex
children	m730:CodiceFiscale m730:Email m730:Telefono m730:Cellulare
source	<code><xs:element name="SoggettoFiscale" type="m730:Soggetto_Fiscale_730_Type"/></code>

element **Frontespizio_730_Type/DatiAnagrafici**

diagram	<p>The diagram illustrates the structure of the <code>sc:Dati_Anagrafici_Type</code> element. It is a complex type containing six child elements: <code>Cognome</code>, <code>Nome</code>, <code>Sesso</code>, <code>DataNascita</code>, <code>ComuneNascita</code>, and <code>ProvinciaNascita</code>. The <code>Cognome</code>, <code>Nome</code>, <code>Sesso</code>, <code>DataNascita</code>, and <code>ComuneNascita</code> elements are shown as solid boxes, while <code>ProvinciaNascita</code> is shown as a dashed box. The entire structure is enclosed in a dashed box labeled <code>sc:Dati_Anagrafici_Type</code>.</p>
namespace	urn:www.agenziaentrate.gov.it:specificheTecniche:sco:730:v1
type	Dati_Anagrafici_Type
properties	isRef 0 content complex
children	Cognome Nome Sesso DataNascita ComuneNascita ProvinciaNascita
source	<code><xs:element name="DatiAnagrafici" type="sc:Dati_Anagrafici_Type"/></code>

element **Frontespizio_730_Type/ResidenzaAnagrafica**

<p>diagram</p>	
<p>namespace</p>	<p>urn:www.agenziaentrate.gov.it:specificheTecniche:sco:730:v1</p>
<p>type</p>	<p>m730:Residenza_Anagrafica_730_Type</p>
<p>properties</p>	<p>isRef 0 minOcc 0 maxOcc 1 content complex</p>
<p>children</p>	<p>Comune Provincia CodiceComune Indirizzo Cap DataVariazione m730:Tipologia m730:NumCivico m730:Frazione m730:PrimaPresentazione</p>
<p>source</p>	<pre><xs:element name="ResidenzaAnagrafica" type="m730:Residenza_Anagrafica_730_Type" minOccurs="0"/></pre>

element **Frontespizio_730_Type/DomicilioFiscale01012011**

<p>diagram</p>	
<p>namespace</p>	<p>urn:www.agenziaentrate.gov.it:specificheTecniche:sco:730:v1</p>
<p>type</p>	<p>m730:Domicilio_Fiscale_type</p>
<p>properties</p>	<p>isRef 0 content complex</p>

children	m730:Comune m730:Provincia m730:CodiceComune
source	<pre><xs:element name="DomicilioFiscale01012011" type="m730:Domicilio_Fiscale_type"/></pre>

element Frontespizio_730_Type/AltriDatiDomicilio

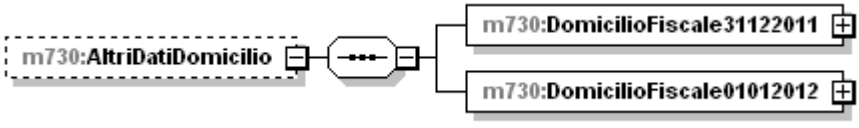
diagram	
namespace	urn:www.agenziaentrate.gov.it:specificheTecniche:sco:730:v1
properties	isRef 0 minOcc 0 maxOcc 1 content complex
children	m730:DomicilioFiscale31122011 m730:DomicilioFiscale01012012
source	<pre><xs:element name="AltriDatiDomicilio" minOccurs="0"> <xs:complexType> <xs:sequence> <xs:element name="DomicilioFiscale31122011" type="m730:Domicilio_Fiscale_type"/> <xs:element name="DomicilioFiscale01012012" type="m730:Domicilio_Fiscale_type"/> </xs:sequence> </xs:complexType> </xs:element></pre>

element Frontespizio_730_Type/AltriDatiDomicilio/DomicilioFiscale31122011

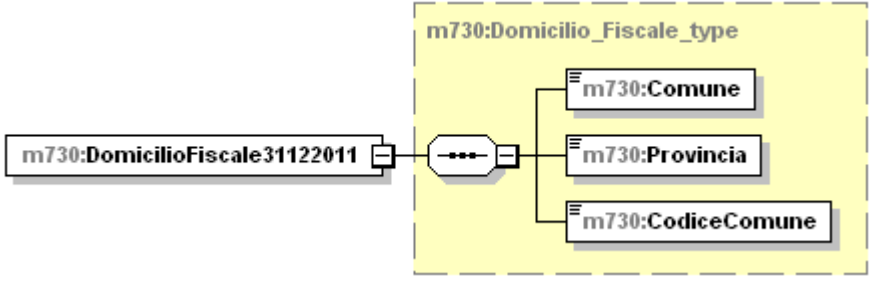
diagram	
namespace	urn:www.agenziaentrate.gov.it:specificheTecniche:sco:730:v1
type	m730:Domicilio_Fiscale_type
properties	isRef 0 content complex
children	m730:Comune m730:Provincia m730:CodiceComune
source	<pre><xs:element name="DomicilioFiscale31122011" type="m730:Domicilio_Fiscale_type"/></pre>

element Frontespizio_730_Type/AltriDatiDomicilio/DomicilioFiscale01012012

diagram	
namespace	urn:www.agenziaentrate.gov.it:specificheTecniche:sco:730:v1
type	m730:Domicilio_Fiscale_type
properties	isRef 0 content complex
children	m730:Comune m730:Provincia m730:CodiceComune
source	<pre><xs:element name="DomicilioFiscale01012012" type="m730:Domicilio_Fiscale_type"/></pre>

element Frontespizio_730_Type/Firma

diagram	
namespace	urn:www.agenziaentrate.gov.it:specificheTecniche:sco:730:v1
type	m730:Firma_Dichiarazione_Type
properties	isRef 0 content complex
children	m730:NumeroModelli m730:FirmaDichiarazione m730:OpzioneInformativa m730:SoggettoFiscalmenteCarico
source	<pre><xs:element name="Firma" type="m730:Firma_Dichiarazione_Type"/></pre>

complexType Frontespizio_Con_Type

diagram	
namespace	urn:www.agenziaentrate.gov.it:specificheTecniche:sco:730:v1
type	extension of m730:Frontespizio_730_Type
properties	base m730:Frontespizio_730_Type
children	m730:SoggettoFiscale m730:DatiAnagrafici m730:ResidenzaAnagrafica m730:DomicilioFiscale01012011 m730:AltriDatiDomicilio m730:Firma m730:StatoCivile
used by	element Dichiarazione Con Type/Frontespizio
source	<pre> <xs:complexType name="Frontespizio_Con_Type"> <xs:complexContent> <xs:extension base="m730:Frontespizio_730_Type"> <xs:sequence> <xs:element name="StatoCivile" type="m730:Stato_Civile_Coniuge_Type"/> </xs:sequence> </xs:extension> </xs:complexContent> </xs:complexType> </pre>

element Frontespizio_Con_Type/StatoCivile

diagram													
namespace	urn:www.agenziaentrate.gov.it:specificheTecniche:sco:730:v1												
type	m730:Stato_Civile_Coniuge_Type												
properties	isRef 0 content simple												
facets	<table border="1"> <thead> <tr> <th>Kind</th> <th>Value</th> <th>annotation</th> </tr> </thead> <tbody> <tr> <td>pattern</td> <td>[1-9]{1}[0-9]*</td> <td></td> </tr> <tr> <td>enumeration</td> <td>2</td> <td></td> </tr> <tr> <td>enumeration</td> <td>4</td> <td></td> </tr> </tbody> </table>	Kind	Value	annotation	pattern	[1-9]{1}[0-9]*		enumeration	2		enumeration	4	
Kind	Value	annotation											
pattern	[1-9]{1}[0-9]*												
enumeration	2												
enumeration	4												

source	<pre><xs:element name="StatoCivile" type="m730:Stato_Civile_Coniuge_Type"/></pre>
--------	---

complexType Frontespizio_Dich_Type

diagram	<p>The diagram illustrates the structure of the <code>Frontespizio_Dich_Type</code> complex type. It is an extension of the <code>m730:Frontespizio_730_Type</code>. The extension includes the following elements:</p> <ul style="list-style-type: none"> <code>m730:SoggettoFiscale</code> (required) <code>m730:DatiAnagrafici</code> (required) <code>m730:ResidenzaAnagrafica</code> (optional, indicated by a dashed line) <code>m730:DomicilioFiscale01012011</code> (required) <code>m730:AltriDatiDomicilio</code> (optional, indicated by a dashed line) <code>m730:Firma</code> (required) <code>m730:StatoCivile</code> (required) <code>m730:Rappresentante</code> (optional, indicated by a dashed line)
namespace	urn:www.agenziaentrate.gov.it:specificheTecniche:sco:730:v1
type	extension of m730:Frontespizio_730_Type
properties	base <code>m730:Frontespizio_730_Type</code>
children	m730:SoggettoFiscale m730:DatiAnagrafici m730:ResidenzaAnagrafica m730:DomicilioFiscale01012011 m730:AltriDatiDomicilio m730:Firma m730:StatoCivile m730:Rappresentante
used by	element Dichiarazione Dich Type/Frontespizio
source	<pre><xs:complexType name="Frontespizio_Dich_Type"> <xs:complexContent> <xs:extension base="m730:Frontespizio_730_Type"> <xs:sequence> <xs:element name="StatoCivile" type="m730:Stato_Civile_Type"/> <xs:element name="Rappresentante" minOccurs="0"> <xs:complexType> <xs:sequence> <xs:element name="SoggettoFiscale" type="m730:Soggetto_Fiscale_730_Type"/> <xs:element name="DatiAnagrafici" type="sc:Dati_Anagrafici_Type"/> <xs:element name="ResidenzaAnagrafica" type="m730:Residenza_Rappresentante_Type" minOccurs="0"/> <xs:element name="Firma"</pre>

```

type="cm:DatoCB_Type"/>
    </xs:sequence>
</xs:complexType>
</xs:element>
</xs:sequence>
</xs:extension>
</xs:complexContent>
</xs:complexType>

```

element Frontespizio_Dich_Type/StatoCivile

diagram																												
namespace	urn:www.agenziaentrate.gov.it:specificheTecniche:sco:730:v1																											
type	m730:Stato_Civile_Type																											
properties	isRef 0 content simple																											
facets	<table border="1"> <thead> <tr> <th>Kind</th> <th>Value</th> <th>annotation</th> </tr> </thead> <tbody> <tr> <td>pattern</td> <td>[1-9]{1}[0-9]*</td> <td></td> </tr> <tr> <td>enumeration</td> <td>1</td> <td></td> </tr> <tr> <td>enumeration</td> <td>2</td> <td></td> </tr> <tr> <td>enumeration</td> <td>3</td> <td></td> </tr> <tr> <td>enumeration</td> <td>4</td> <td></td> </tr> <tr> <td>enumeration</td> <td>5</td> <td></td> </tr> <tr> <td>enumeration</td> <td>7</td> <td></td> </tr> <tr> <td>enumeration</td> <td>8</td> <td></td> </tr> </tbody> </table>	Kind	Value	annotation	pattern	[1-9]{1}[0-9]*		enumeration	1		enumeration	2		enumeration	3		enumeration	4		enumeration	5		enumeration	7		enumeration	8	
Kind	Value	annotation																										
pattern	[1-9]{1}[0-9]*																											
enumeration	1																											
enumeration	2																											
enumeration	3																											
enumeration	4																											
enumeration	5																											
enumeration	7																											
enumeration	8																											
source	<code><xs:element name="StatoCivile" type="m730:Stato_Civile_Type"/></code>																											

element Frontespizio_Dich_Type/Rappresentante

diagram	
namespace	urn:www.agenziaentrate.gov.it:specificheTecniche:sco:730:v1
properties	isRef 0 minOcc 0 maxOcc 1 content complex
children	m730:SoggettoFiscale m730:DatiAnagrafici m730:ResidenzaAnagrafica m730:Firma
source	<code><xs:element name="Rappresentante" minOccurs="0"> <xs:complexType></code>

	<pre> <xs:sequence> <xs:element name="SoggettoFiscale" type="m730:Soggetto_Fiscale_730_Type"/> <xs:element name="DatiAnagrafici" type="sc:Dati_Anagrafici_Type"/> <xs:element name="ResidenzaAnagrafica" type="m730:Residenza_Rappresentante_Type" minOccurs="0"/> <xs:element name="Firma" type="cm:DatoCB_Type"/> </xs:sequence> </xs:complexType> </xs:element> </pre>
--	---

element **Frontespizio_Dich_Type/Rappresentante/SoggettoFiscale**

diagram	<p>The diagram illustrates the structure of the <code>m730:SoggettoFiscale</code> element. It is a complex type that contains four child elements: <code>m730:CodiceFiscale</code>, <code>m730:Email</code>, <code>m730:Telefono</code>, and <code>m730:Cellulare</code>. The <code>m730:SoggettoFiscale</code> element is shown as a solid box, and the child elements are shown as dashed boxes. The child elements are connected to the parent element by lines, indicating a composition relationship.</p>
namespace	urn:www.agenziaentrate.gov.it:specificheTecniche:sco:730:v1
type	m730:Soggetto_Fiscale_730_Type
properties	isRef 0 content complex
children	m730:CodiceFiscale m730:Email m730:Telefono m730:Cellulare
source	<pre> <xs:element name="SoggettoFiscale" type="m730:Soggetto_Fiscale_730_Type"/> </pre>

element **Frontespizio_Dich_Type/Rappresentante/DatiAnagrafici**

diagram	
namespace	urn:www.agenziaentrate.gov.it:specificheTecniche:sco:730:v1
type	Dati_Anagrafici_Type
properties	isRef 0 content complex
children	Cognome Nome Sesso DataNascita ComuneNascita ProvinciaNascita
source	<code><xs:element name="DatiAnagrafici" type="sc:Dati_Anagrafici_Type"/></code>

element **Frontespizio_Dich_Type/Rappresentante/ResidenzaAnagrafica**

diagram	
namespace	urn:www.agenziaentrate.gov.it:specificheTecniche:sco:730:v1

type	m730:Residenza_Rappresentante_Type
properties	isRef 0 minOcc 0 maxOcc 1 content complex
children	Comune Provincia CodiceComune Indirizzo Cap m730:Tipologia m730:NumCivico m730:Frazione m730:PrimaPresentazione
source	<code><xs:element name="ResidenzaAnagrafica" type="m730:Residenza_Rappresentante_Type" minOccurs="0"/></code>

element Frontespizio_Dich_Type/Rappresentante/Firma

diagram	
namespace	urn:www.agenziaentrate.gov.it:specificheTecniche:sco:730:v1
type	DatoCB_Type
properties	isRef 0 content simple
facets	Kind Value annotation pattern [01]
source	<code><xs:element name="Firma" type="cm:DatoCB_Type"/></code>

complexType Fuori_Assistenza_Type

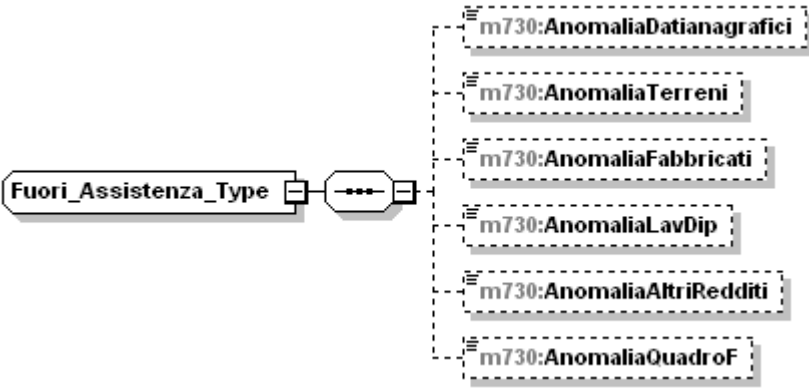
diagram	
namespace	urn:www.agenziaentrate.gov.it:specificheTecniche:sco:730:v1
children	m730:AnomaliaDatianagrafici m730:AnomaliaTerreni m730:AnomaliaFabbricati m730:AnomaliaLavDip m730:AnomaliaAltriRedditi m730:AnomaliaQuadroF
used by	elements Dichiarazione Dich_Type/FuoriAssistenza/FuoriAssistenzaQuadri Dichiarazione Con Type/FuoriAssistenzaQuadri
source	<pre><xs:complexType name="Fuori_Assistenza_Type"> <xs:sequence> <xs:element name="AnomaliaDatianagrafici" type="cm:DatoCB_Type" minOccurs="0"/> <xs:element name="AnomaliaTerreni" type="cm:DatoCB_Type" minOccurs="0"/> <xs:element name="AnomaliaFabbricati"</pre>

	<pre> type="cm:DatoCB_Type" minOccurs="0"/> <xs:element name="AnomaliaLavDip" type="cm:DatoCB_Type" minOccurs="0"/> <xs:element name="AnomaliaAltriRedditi" type="cm:DatoCB_Type" minOccurs="0"/> <xs:element name="AnomaliaQuadroF" type="cm:DatoCB_Type" minOccurs="0"/> </xs:sequence> </xs:complexType> </pre>
--	---

element Fuori_Assistenza_Type/AnomaliaDatianagrafici

diagram	
namespace	urn:www.agenziaentrate.gov.it:specificheTecniche:sco:730:v1
type	DatoCB_Type
properties	isRef 0 minOcc 0 maxOcc 1 content simple
facets	Kind Value annotation pattern [01]
source	<pre> <xs:element name="AnomaliaDatianagrafici" type="cm:DatoCB_Type" minOccurs="0"/> </pre>

element Fuori_Assistenza_Type/AnomaliaTerreni

diagram	
namespace	urn:www.agenziaentrate.gov.it:specificheTecniche:sco:730:v1
type	DatoCB_Type
properties	isRef 0 minOcc 0 maxOcc 1 content simple
facets	Kind Value annotation pattern [01]
source	<pre> <xs:element name="AnomaliaTerreni" type="cm:DatoCB_Type" minOccurs="0"/> </pre>

element Fuori_Assistenza_Type/AnomaliaFabbricati

diagram	
namespace	urn:www.agenziaentrate.gov.it:specificheTecniche:sco:730:v1
type	DatoCB_Type

properties	isRef 0 minOcc 0 maxOcc 1 content simple
facets	Kind Value annotation pattern [01]
source	<code><xs:element name="AnomaliaFabbricati" type="cm:DatoCB_Type" minOccurs="0"/></code>

element Fuori_Assistenza_Type/AnomaliaLavDip

diagram	
namespace	urn:www.agenziaentrate.gov.it:specificheTecniche:sco:730:v1
type	DatoCB_Type
properties	isRef 0 minOcc 0 maxOcc 1 content simple
facets	Kind Value annotation pattern [01]
source	<code><xs:element name="AnomaliaLavDip" type="cm:DatoCB_Type" minOccurs="0"/></code>

element Fuori_Assistenza_Type/AnomaliaAltriRedditi

diagram	
namespace	urn:www.agenziaentrate.gov.it:specificheTecniche:sco:730:v1
type	DatoCB_Type
properties	isRef 0 minOcc 0 maxOcc 1 content simple
facets	Kind Value annotation pattern [01]
source	<code><xs:element name="AnomaliaAltriRedditi" type="cm:DatoCB_Type" minOccurs="0"/></code>

element Fuori_Assistenza_Type/AnomaliaQuadroF

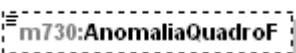
diagram	
namespace	urn:www.agenziaentrate.gov.it:specificheTecniche:sco:730:v1
type	DatoCB_Type
properties	isRef 0 minOcc 0 maxOcc 1

	content simple
facets	Kind Value annotation pattern [01]
source	<code><xs:element name="AnomaliaQuadroF" type="cm:DatoCB_Type" minOccurs="0"/></code>

complexType Giorni_Percentuale_Type

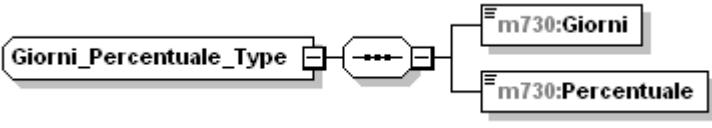
diagram	
namespace	urn:www.agenziaentrate.gov.it:specificheTecniche:sco:730:v1
children	m730:Giorni m730:Percentuale
used by	elements Detrazioni Canoni Locazione Type/DipendentiTrasferiti Inquilini Abitazione Principale Type/GiorniPercentuale
source	<code><xs:complexType name="Giorni_Percentuale_Type"> <xs:sequence> <xs:element name="Giorni" type="cm:DatoNP_Type"/> <xs:element name="Percentuale" type="cm:DatoPC_Type"/> </xs:sequence> </xs:complexType></code>

element Giorni_Percentuale_Type/Giorni

diagram	
namespace	urn:www.agenziaentrate.gov.it:specificheTecniche:sco:730:v1
type	DatoNP_Type
properties	isRef 0 content simple
facets	Kind Value annotation pattern [1-9]{1}[0-9]*
source	<code><xs:element name="Giorni" type="cm:DatoNP_Type"/></code>

element Giorni_Percentuale_Type/Percentuale

diagram	
namespace	urn:www.agenziaentrate.gov.it:specificheTecniche:sco:730:v1
type	DatoPC_Type
properties	isRef 0 content simple
facets	Kind Value annotation maxLength 16 pattern [0-9]?[0-9](,\d{1,3})? 100,(0{1,3})?

source	<code><xs:element name="Percentuale" type="cm:DatoPC_Type"/></code>
--------	---

complexType ICI_Type

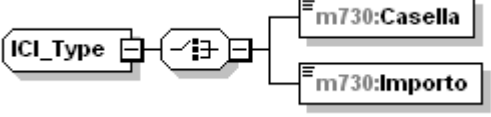
diagram	
namespace	urn:www.agenziaentrate.gov.it:specificheTecniche:sco:730:v1
children	m730:Casella m730:Importo
used by	element Dati Contabili Type/Quadrol
source	<pre><xs:complexType name="ICI_Type"> <xs:choice> <xs:element name="Casella" type="cm:DatoCB_Type"/> <xs:element name="Importo" type="cm:DatoNP_Type"/> </xs:choice> </xs:complexType></pre>

element ICI_Type/Casella

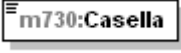
diagram	
namespace	urn:www.agenziaentrate.gov.it:specificheTecniche:sco:730:v1
type	DatoCB_Type
properties	isRef 0 content simple
facets	Kind Value annotation pattern [01]
source	<code><xs:element name="Casella" type="cm:DatoCB_Type"/></code>

element ICI_Type/Importo

diagram	
namespace	urn:www.agenziaentrate.gov.it:specificheTecniche:sco:730:v1
type	DatoNP_Type
properties	isRef 0 content simple
facets	Kind Value annotation pattern [1-9]{1}[0-9]*
source	<code><xs:element name="Importo" type="cm:DatoNP_Type"/></code>

complexType Importi_Rimborsare730-4_Type

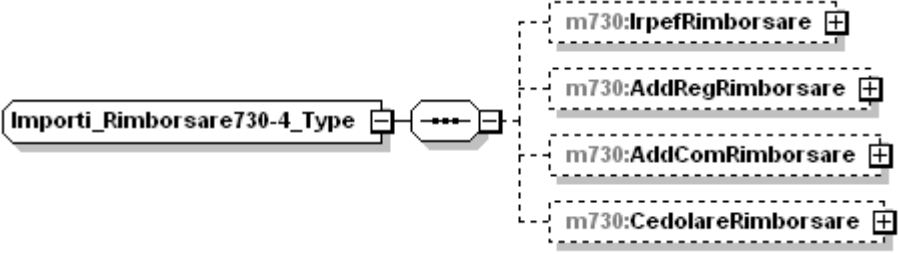
diagram	 <p>The diagram illustrates the structure of the <code>Importi_Rimborsare730-4_Type</code> complex type. It is represented as a rounded rectangle containing a smaller rounded rectangle with three dots, indicating a sequence of elements. Four dashed boxes, each containing a plus sign, are connected to the right side of the main box, representing the elements: <code>m730:IrpefRimborsare</code>, <code>m730:AddRegRimborsare</code>, <code>m730:AddComRimborsare</code>, and <code>m730:CedolareRimborsare</code>.</p>
namespace	urn:www.agenziaentrate.gov.it:specificheTecniche:sco:730:v1
children	m730:IrpefRimborsare m730:AddRegRimborsare m730:AddComRimborsare m730:CedolareRimborsare
used by	elements Documento 730-4/DatiContabili730-4/Ordinario 730-4/ImportiRimborsare Documento 730-4/DatiContabili730-4/Integrativo 730-4/ImportiRimborsare
source	<pre> <xs:complexType name="Importi_Rimborsare730-4_Type"> <xs:sequence> <xs:element name="IrpefRimborsare" type="m730:Importo_730-4" minOccurs="0"/> <xs:element name="AddRegRimborsare" minOccurs="0"> <xs:complexType> <xs:sequence> <xs:element name="ImportoAddizionale" type="m730:Importo_730-4"/> <xs:element name="CodiceRegione" type="sc:Codice_Regione_Type"/> </xs:sequence> </xs:complexType> </xs:element> <xs:element name="AddComRimborsare" minOccurs="0"> <xs:complexType> <xs:sequence> <xs:element name="ImportoAddizionale" type="m730:Importo_730-4"/> <xs:element name="CodiceComune" type="cm:DatoAN_Type"/> </xs:sequence> </xs:complexType> </xs:element> <xs:element name="CedolareRimborsare" type="m730:Importo_730-4" minOccurs="0"/> </xs:sequence> </xs:complexType> </pre>

element **Importi_Rimborsare730-4_Type/IrpefRimborsare**

diagram	
namespace	urn:www.agenziaentrate.gov.it:specificheTecniche:sco:730:v1
type	m730:Importo_730-4
properties	isRef 0 minOcc 0 maxOcc 1 content complex
children	m730:ImportoDichiarante m730:ImportoConiuge m730:ImportoTotale
source	<pre><xs:element name="IrpefRimborsare" type="m730:Importo_730-4" minOccurs="0"/></pre>

element **Importi_Rimborsare730-4_Type/AddRegRimborsare**

diagram	
namespace	urn:www.agenziaentrate.gov.it:specificheTecniche:sco:730:v1
properties	isRef 0 minOcc 0 maxOcc 1 content complex
children	m730:ImportoAddizionale m730:CodiceRegione
source	<pre><xs:element name="AddRegRimborsare" minOccurs="0"> <xs:complexType> <xs:sequence> <xs:element name="ImportoAddizionale" type="m730:Importo_730-4"/> <xs:element name="CodiceRegione" type="sc:Codice_Regione_Type"/> </xs:sequence> </xs:complexType> </xs:element></pre>

element **Importi_Rimborsare730-4_Type/AddRegRimborsare/ImportoAddizionale**

diagram	
namespace	urn:www.agenziaentrate.gov.it:specificheTecniche:sco:730:v1
type	m730:Importo_730-4
properties	isRef 0 content complex
children	m730:ImportoDichiarante m730:ImportoConiuge m730:ImportoTotale
source	<code><xs:element name="ImportoAddizionale" type="m730:Importo_730-4" /></code>

element **Importi_Rimborsare730-4_Type/AddRegRimborsare/CodiceRegione**

diagram																																																																
namespace	urn:www.agenziaentrate.gov.it:specificheTecniche:sco:730:v1																																																															
type	Codice Regione Type																																																															
properties	isRef 0 content simple																																																															
facets	<table border="1"> <thead> <tr> <th>Kind</th> <th>Value</th> <th>annotation</th> </tr> </thead> <tbody> <tr> <td>pattern</td> <td>[0-9A-Z]{1}([0-9A-Z] \- \.& _ \\s / ^\\(\\))*</td> <td></td> </tr> <tr> <td>enumeration</td> <td>1</td> <td></td> </tr> <tr> <td>enumeration</td> <td>2</td> <td></td> </tr> <tr> <td>enumeration</td> <td>3</td> <td></td> </tr> <tr> <td>enumeration</td> <td>4</td> <td></td> </tr> <tr> <td>enumeration</td> <td>5</td> <td></td> </tr> <tr> <td>enumeration</td> <td>6</td> <td></td> </tr> <tr> <td>enumeration</td> <td>7</td> <td></td> </tr> <tr> <td>enumeration</td> <td>8</td> <td></td> </tr> <tr> <td>enumeration</td> <td>9</td> <td></td> </tr> <tr> <td>enumeration</td> <td>10</td> <td></td> </tr> <tr> <td>enumeration</td> <td>11</td> <td></td> </tr> <tr> <td>enumeration</td> <td>12</td> <td></td> </tr> <tr> <td>enumeration</td> <td>13</td> <td></td> </tr> <tr> <td>enumeration</td> <td>14</td> <td></td> </tr> <tr> <td>enumeration</td> <td>15</td> <td></td> </tr> <tr> <td>enumeration</td> <td>16</td> <td></td> </tr> <tr> <td>enumeration</td> <td>17</td> <td></td> </tr> <tr> <td>enumeration</td> <td>18</td> <td></td> </tr> <tr> <td>enumeration</td> <td>19</td> <td></td> </tr> </tbody> </table>	Kind	Value	annotation	pattern	[0-9A-Z]{1}([0-9A-Z] \- \.& _ \\s / ^\\(\\))*		enumeration	1		enumeration	2		enumeration	3		enumeration	4		enumeration	5		enumeration	6		enumeration	7		enumeration	8		enumeration	9		enumeration	10		enumeration	11		enumeration	12		enumeration	13		enumeration	14		enumeration	15		enumeration	16		enumeration	17		enumeration	18		enumeration	19	
Kind	Value	annotation																																																														
pattern	[0-9A-Z]{1}([0-9A-Z] \- \.& _ \\s / ^\\(\\))*																																																															
enumeration	1																																																															
enumeration	2																																																															
enumeration	3																																																															
enumeration	4																																																															
enumeration	5																																																															
enumeration	6																																																															
enumeration	7																																																															
enumeration	8																																																															
enumeration	9																																																															
enumeration	10																																																															
enumeration	11																																																															
enumeration	12																																																															
enumeration	13																																																															
enumeration	14																																																															
enumeration	15																																																															
enumeration	16																																																															
enumeration	17																																																															
enumeration	18																																																															
enumeration	19																																																															

	enumeration 20 enumeration 21
source	<code><xs:element name="CodiceRegione" type="sc:Codice_Regione_Type"/></code>

element **Importi_Rimborsare730-4_Type/AddComRimborsare**

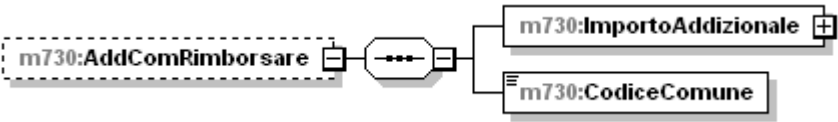
diagram	
namespace	urn:www.agenziaentrate.gov.it:specificheTecniche:sco:730:v1
properties	isRef 0 minOcc 0 maxOcc 1 content complex
children	m730:ImportoAddizionale m730:CodiceComune
source	<code><xs:element name="AddComRimborsare" minOccurs="0"> <xs:complexType> <xs:sequence> <xs:element name="ImportoAddizionale" type="m730:Importo_730-4"/> <xs:element name="CodiceComune" type="cm:DatoAN_Type"/> </xs:sequence> </xs:complexType> </xs:element></code>

element **Importi_Rimborsare730-4_Type/AddComRimborsare/ImportoAddizionale**

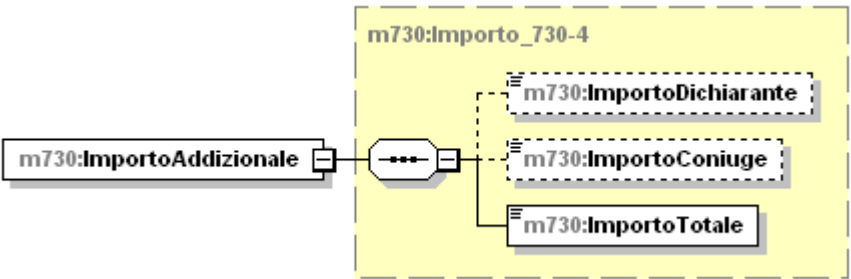
diagram	
namespace	urn:www.agenziaentrate.gov.it:specificheTecniche:sco:730:v1
type	m730:Importo_730-4
properties	isRef 0 content complex
children	m730:ImportoDichiarante m730:ImportoConiuge m730:ImportoTotale
source	<code><xs:element name="ImportoAddizionale" type="m730:Importo_730-4"/></code>

element **Importi_Rimborsare730-4_Type/AddComRimborsare/CodiceComune**

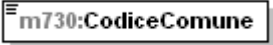
diagram	
namespace	urn:www.agenziaentrate.gov.it:specificheTecniche:sco:730:v1
type	DatoAN_Type
properties	isRef 0 content simple
facets	Kind Value pattern [0-9A-Z-]{1}([0-9A-Z] \. \& _ / \^ \) annotation
source	<code><xs:element name="CodiceComune" type="cm:DatoAN_Type"/></code>

element **Importi_Rimborsare730-4_Type/CedolareRimborsare**

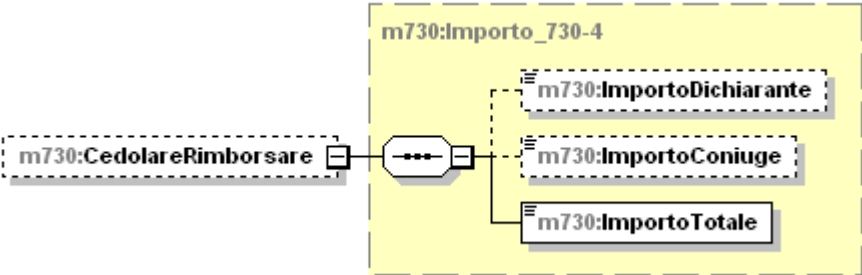
diagram	
namespace	urn:www.agenziaentrate.gov.it:specificheTecniche:sco:730:v1
type	m730:Importo_730-4
properties	isRef 0 minOcc 0 maxOcc 1 content complex
children	m730:ImportoDichiarante m730:ImportoConiuge m730:ImportoTotale
source	<code><xs:element name="CedolareRimborsare" type="m730:Importo_730-4" minOccurs="0"/></code>

complexType **ImportiTrattenerere730-4**

<p>diagram</p>	
<p>namespace</p>	<p>urn:www.agenziaentrate.gov.it:specificheTecniche:sco:730:v1</p>
<p>children</p>	<p>m730:IrpefTrattenerere m730:AddRegTrattenerere m730:AddComTrattenerere m730:IrpefPrimaRataTrattenerere m730:IrpefSecondaRataTrattenerere m730:TassSepAccontoTrattenerere m730:AddComAccontoTrattenerere m730:IncrProduitTrattenerere m730:CedolareTrattenerere m730:CedolarePrimaRataTrattenerere m730:CedolareSecondaRataTrattenerere m730:ContribSolidTrattenerere</p>
<p>used by</p>	<p>element Documento_730-4/DatiContabili730-4/Ordinario_730-4/ImportiTrattenerere</p>
<p>source</p>	<pre><xs:complexType name="ImportiTrattenerere730-4"> <xs:sequence> <xs:element name="IrpefTrattenerere" type="m730:Importo_730-4" minOccurs="0"/> <xs:element name="AddRegTrattenerere" minOccurs="0"> <xs:complexType> <xs:sequence> <xs:element name="ImportoAddizionale" type="m730:Importo_730-4"/> <xs:element name="CodiceRegione" type="sc:Codice_Regione_Type"/> </xs:sequence> </xs:complexType> </xs:element> <xs:element name="AddComTrattenerere" minOccurs="0"> <xs:complexType> <xs:sequence> <xs:element name="ImportoAddizionale"</pre>

```

type="m730:Importo_730-4"/>
    <xs:element name="CodiceComune"
type="cm:DatoAN_Type"/>
    </xs:sequence>
  </xs:complexType>
</xs:element>
  <xs:element name="IrpefPrimaRataTrattenerere"
type="m730:Importo_730-4" minOccurs="0"/>
  <xs:element name="IrpefSecondaRataTrattenerere"
type="m730:Importo_730-4" minOccurs="0"/>
  <xs:element name="TassSepAccontoTrattenerere"
type="m730:Importo_730-4" minOccurs="0"/>
  <xs:element name="AddComAccontoTrattenerere">
    <xs:complexType>
      <xs:sequence>
        <xs:element name="ImportoAddizionale"
type="m730:Importo_730-4"/>
          <xs:element name="CodiceComune"
type="cm:DatoAN_Type"/>
        </xs:sequence>
      </xs:complexType>
    </xs:element>
    <xs:element name="IncrProdutTrattenerere"
type="m730:Importo_730-4" minOccurs="0"/>
    <xs:element name="CedolareTrattenerere"
type="m730:Importo_730-4" minOccurs="0"/>
    <xs:element name="CedolarePrimaRataTrattenerere"
type="m730:Importo_730-4" minOccurs="0"/>
    <xs:element name="CedolareSecondaRataTrattenerere"
type="m730:Importo_730-4" minOccurs="0"/>
    <xs:element name="ContribSolidTrattenerere"
type="m730:Importo_730-4" minOccurs="0"/>
  </xs:sequence>
</xs:complexType>

```

element ImportiTrattenerere730-4/IrpefTrattenerere

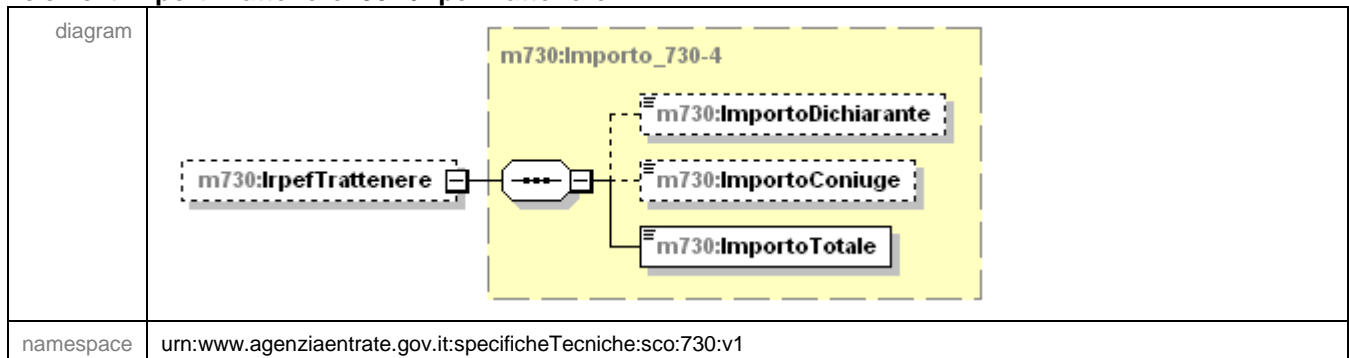

type	m730:Importo_730-4
properties	isRef 0 minOcc 0 maxOcc 1 content complex
children	m730:ImportoDichiarante m730:ImportoConiuge m730:ImportoTotale
source	<pre><xs:element name="IrpefTrattenerere" type="m730:Importo_730-4" minOccurs="0"/></pre>

element ImportiTrattenerere730-4/AddRegTrattenerere

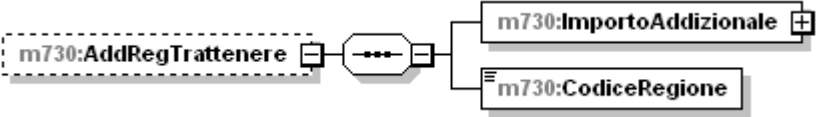
diagram	
namespace	urn:www.agenziaentrate.gov.it:specificheTecniche:sco:730:v1
properties	isRef 0 minOcc 0 maxOcc 1 content complex
children	m730:ImportoAddizionale m730:CodiceRegione
source	<pre><xs:element name="AddRegTrattenerere" minOccurs="0"> <xs:complexType> <xs:sequence> <xs:element name="ImportoAddizionale" type="m730:Importo_730-4"/> <xs:element name="CodiceRegione" type="sc:Codice_Regione_Type"/> </xs:sequence> </xs:complexType> </xs:element></pre>

element ImportiTrattenerere730-4/AddRegTrattenerere/ImportoAddizionale

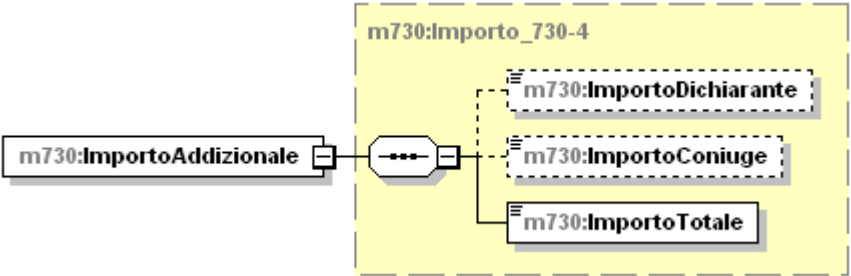
diagram	
namespace	urn:www.agenziaentrate.gov.it:specificheTecniche:sco:730:v1
type	m730:Importo_730-4
properties	isRef 0 content complex

children	m730:ImportoDichiarante m730:ImportoConiuge m730:ImportoTotale
source	<code><xs:element name="ImportoAddizionale" type="m730:Importo_730-4"/></code>

element **ImportiTrattenere730-4/AddRegTrattenere/CodiceRegione**

diagram																																																																						
namespace	urn:www.agenziaentrate.gov.it:specificheTecniche:sco:730:v1																																																																					
type	Codice Regione Type																																																																					
properties	isRef 0 content simple																																																																					
facets	<table border="0"> <tr> <td>Kind</td> <td>Value</td> <td>annotation</td> </tr> <tr> <td>pattern</td> <td>[0-9A-Z-]{1}([0-9A-Z] \- \. &amp; , \s / \^ \(\))*</td> <td></td> </tr> <tr> <td>enumeration</td> <td>1</td> <td></td> </tr> <tr> <td>enumeration</td> <td>2</td> <td></td> </tr> <tr> <td>enumeration</td> <td>3</td> <td></td> </tr> <tr> <td>enumeration</td> <td>4</td> <td></td> </tr> <tr> <td>enumeration</td> <td>5</td> <td></td> </tr> <tr> <td>enumeration</td> <td>6</td> <td></td> </tr> <tr> <td>enumeration</td> <td>7</td> <td></td> </tr> <tr> <td>enumeration</td> <td>8</td> <td></td> </tr> <tr> <td>enumeration</td> <td>9</td> <td></td> </tr> <tr> <td>enumeration</td> <td>10</td> <td></td> </tr> <tr> <td>enumeration</td> <td>11</td> <td></td> </tr> <tr> <td>enumeration</td> <td>12</td> <td></td> </tr> <tr> <td>enumeration</td> <td>13</td> <td></td> </tr> <tr> <td>enumeration</td> <td>14</td> <td></td> </tr> <tr> <td>enumeration</td> <td>15</td> <td></td> </tr> <tr> <td>enumeration</td> <td>16</td> <td></td> </tr> <tr> <td>enumeration</td> <td>17</td> <td></td> </tr> <tr> <td>enumeration</td> <td>18</td> <td></td> </tr> <tr> <td>enumeration</td> <td>19</td> <td></td> </tr> <tr> <td>enumeration</td> <td>20</td> <td></td> </tr> <tr> <td>enumeration</td> <td>21</td> <td></td> </tr> </table>	Kind	Value	annotation	pattern	[0-9A-Z-]{1}([0-9A-Z] \- \. & , \s / \^ \(\))*		enumeration	1		enumeration	2		enumeration	3		enumeration	4		enumeration	5		enumeration	6		enumeration	7		enumeration	8		enumeration	9		enumeration	10		enumeration	11		enumeration	12		enumeration	13		enumeration	14		enumeration	15		enumeration	16		enumeration	17		enumeration	18		enumeration	19		enumeration	20		enumeration	21	
Kind	Value	annotation																																																																				
pattern	[0-9A-Z-]{1}([0-9A-Z] \- \. & , \s / \^ \(\))*																																																																					
enumeration	1																																																																					
enumeration	2																																																																					
enumeration	3																																																																					
enumeration	4																																																																					
enumeration	5																																																																					
enumeration	6																																																																					
enumeration	7																																																																					
enumeration	8																																																																					
enumeration	9																																																																					
enumeration	10																																																																					
enumeration	11																																																																					
enumeration	12																																																																					
enumeration	13																																																																					
enumeration	14																																																																					
enumeration	15																																																																					
enumeration	16																																																																					
enumeration	17																																																																					
enumeration	18																																																																					
enumeration	19																																																																					
enumeration	20																																																																					
enumeration	21																																																																					
source	<code><xs:element name="CodiceRegione" type="sc:Codice_Regione_Type"/></code>																																																																					

element **ImportiTrattenere730-4/AddComTrattenere**

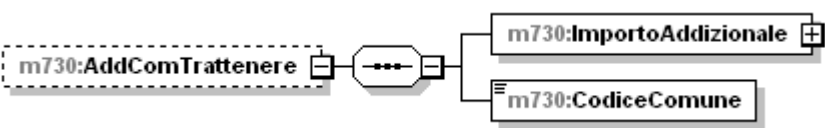
diagram	
namespace	urn:www.agenziaentrate.gov.it:specificheTecniche:sco:730:v1

properties	isRef 0 minOcc 0 maxOcc 1 content complex
children	m730:ImportoAddizionale m730:CodiceComune
source	<pre><xs:element name="AddComTrattenere" minOccurs="0"> <xs:complexType> <xs:sequence> <xs:element name="ImportoAddizionale" type="m730:Importo_730-4"/> <xs:element name="CodiceComune" type="cm:DatoAN_Type"/> </xs:sequence> </xs:complexType> </xs:element></pre>

element ImportiTrattenere730-4/AddComTrattenere/ImportoAddizionale

diagram	<p>The diagram illustrates the structure of the <code>m730:ImportoAddizionale</code> element. It is a complex type containing three elements: <code>m730:ImportoDichiarante</code>, <code>m730:ImportoConiuge</code>, and <code>m730:ImportoTotale</code>. The elements are shown in a hierarchical view with dashed lines indicating relationships.</p>
namespace	urn:www.agenziaentrate.gov.it:specificheTecniche:sco:730:v1
type	m730:Importo_730-4
properties	isRef 0 content complex
children	m730:ImportoDichiarante m730:ImportoConiuge m730:ImportoTotale
source	<pre><xs:element name="ImportoAddizionale" type="m730:Importo_730-4"/></pre>

element ImportiTrattenere730-4/AddComTrattenere/CodiceComune

diagram	<p>The diagram illustrates the structure of the <code>m730:CodiceComune</code> element. It is a simple type represented by a box labeled <code>m730:CodiceComune</code>.</p>						
namespace	urn:www.agenziaentrate.gov.it:specificheTecniche:sco:730:v1						
type	DatoAN_Type						
properties	isRef 0 content simple						
facets	<table border="0"> <tr> <td>Kind</td> <td>Value</td> <td>annotation</td> </tr> <tr> <td>pattern</td> <td>[0-9A-Z]{1}([0-9A-Z] \- \. &#x26; , \s / \° \^ \()*)</td> <td></td> </tr> </table>	Kind	Value	annotation	pattern	[0-9A-Z]{1}([0-9A-Z] \- \. & , \s / \° \^ \()*)	
Kind	Value	annotation					
pattern	[0-9A-Z]{1}([0-9A-Z] \- \. & , \s / \° \^ \()*)						
source	<pre><xs:element name="CodiceComune" type="cm:DatoAN_Type"/></pre>						

element **ImportiTrattenerere730-4/IrpefPrimaRataTrattenerere**

diagram									
namespace	urn:www.agenziaentrate.gov.it:specificheTecniche:sco:730:v1								
type	m730:Importo_730-4								
properties	<table border="0"> <tr><td>isRef</td><td>0</td></tr> <tr><td>minOcc</td><td>0</td></tr> <tr><td>maxOcc</td><td>1</td></tr> <tr><td>content</td><td>complex</td></tr> </table>	isRef	0	minOcc	0	maxOcc	1	content	complex
isRef	0								
minOcc	0								
maxOcc	1								
content	complex								
children	m730:ImportoDichiarante m730:ImportoConiuge m730:ImportoTotale								
source	<pre><xs:element name="IrpefPrimaRataTrattenerere" type="m730:Importo_730-4" minOccurs="0"/></pre>								

element **ImportiTrattenerere730-4/IrpefSecondaRataTrattenerere**

diagram									
namespace	urn:www.agenziaentrate.gov.it:specificheTecniche:sco:730:v1								
type	m730:Importo_730-4								
properties	<table border="0"> <tr><td>isRef</td><td>0</td></tr> <tr><td>minOcc</td><td>0</td></tr> <tr><td>maxOcc</td><td>1</td></tr> <tr><td>content</td><td>complex</td></tr> </table>	isRef	0	minOcc	0	maxOcc	1	content	complex
isRef	0								
minOcc	0								
maxOcc	1								
content	complex								
children	m730:ImportoDichiarante m730:ImportoConiuge m730:ImportoTotale								
source	<pre><xs:element name="IrpefSecondaRataTrattenerere" type="m730:Importo_730-4" minOccurs="0"/></pre>								

element **ImportiTrattenerere730-4/TassSepAccontoTrattenerere**

diagram									
namespace	urn:www.agenziaentrate.gov.it:specificheTecniche:sco:730:v1								
type	m730:Importo_730-4								
properties	<table> <tr><td>isRef</td><td>0</td></tr> <tr><td>minOcc</td><td>0</td></tr> <tr><td>maxOcc</td><td>1</td></tr> <tr><td>content</td><td>complex</td></tr> </table>	isRef	0	minOcc	0	maxOcc	1	content	complex
isRef	0								
minOcc	0								
maxOcc	1								
content	complex								
children	m730:ImportoDichiarante m730:ImportoConiuge m730:ImportoTotale								
source	<pre><xs:element name="TassSepAccontoTrattenerere" type="m730:Importo_730-4" minOccurs="0"/></pre>								

element **ImportiTrattenerere730-4/AddComAccontoTrattenerere**

diagram					
namespace	urn:www.agenziaentrate.gov.it:specificheTecniche:sco:730:v1				
properties	<table> <tr><td>isRef</td><td>0</td></tr> <tr><td>content</td><td>complex</td></tr> </table>	isRef	0	content	complex
isRef	0				
content	complex				
children	m730:ImportoAddizionale m730:CodiceComune				
source	<pre><xs:element name="AddComAccontoTrattenerere"> <xs:complexType> <xs:sequence> <xs:element name="ImportoAddizionale" type="m730:Importo_730-4"/> <xs:element name="CodiceComune" type="cm:DatoAN_Type"/> </xs:sequence> </xs:complexType> </xs:element></pre>				

element **ImportiTrattenere730-4/AddComAccontoTrattenere/ImportoAddizionale**

diagram	
namespace	urn:www.agenziaentrate.gov.it:specificheTecniche:sco:730:v1
type	m730:Importo_730-4
properties	isRef 0 content complex
children	m730:ImportoDichiarante m730:ImportoConiuge m730:ImportoTotale
source	<code><xs:element name="ImportoAddizionale" type="m730:Importo_730-4"/></code>

element **ImportiTrattenere730-4/AddComAccontoTrattenere/CodiceComune**

diagram	
namespace	urn:www.agenziaentrate.gov.it:specificheTecniche:sco:730:v1
type	DatoAN_Type
properties	isRef 0 content simple
facets	Kind Value annotation pattern [0-9A-Z-]{1}([0-9A-Z] ' \. \& , \/ ° ^\ ()\)*
source	<code><xs:element name="CodiceComune" type="cm:DatoAN_Type"/></code>

element **ImportiTrattenere730-4/IncrProdutTrattenere**

diagram	
namespace	urn:www.agenziaentrate.gov.it:specificheTecniche:sco:730:v1
type	m730:Importo_730-4
properties	isRef 0 minOcc 0 maxOcc 1 content complex

children	m730:ImportoDichiarante m730:ImportoConiuge m730:ImportoTotale
source	<code><xs:element name="IncrProdutTrattenerere" type="m730:Importo_730-4" minOccurs="0"/></code>

element ImportiTrattenerere730-4/CedolareTrattenerere

diagram	
namespace	urn:www.agenziaentrate.gov.it:specificheTecniche:sco:730:v1
type	m730:Importo_730-4
properties	isRef 0 minOcc 0 maxOcc 1 content complex
children	m730:ImportoDichiarante m730:ImportoConiuge m730:ImportoTotale
source	<code><xs:element name="CedolareTrattenerere" type="m730:Importo_730-4" minOccurs="0"/></code>

element ImportiTrattenerere730-4/CedolarePrimaRataTrattenerere

diagram	
namespace	urn:www.agenziaentrate.gov.it:specificheTecniche:sco:730:v1
type	m730:Importo_730-4
properties	isRef 0 minOcc 0 maxOcc 1 content complex
children	m730:ImportoDichiarante m730:ImportoConiuge m730:ImportoTotale
source	<code><xs:element name="CedolarePrimaRataTrattenerere" type="m730:Importo_730-4" minOccurs="0"/></code>

element **ImportiTrattenerere730-4/CedolareSecondaRataTrattenerere**

diagram									
namespace	urn:www.agenziaentrate.gov.it:specificheTecniche:sco:730:v1								
type	m730:Importo_730-4								
properties	<table border="0"> <tr><td>isRef</td><td>0</td></tr> <tr><td>minOcc</td><td>0</td></tr> <tr><td>maxOcc</td><td>1</td></tr> <tr><td>content</td><td>complex</td></tr> </table>	isRef	0	minOcc	0	maxOcc	1	content	complex
isRef	0								
minOcc	0								
maxOcc	1								
content	complex								
children	m730:ImportoDichiarante m730:ImportoConiuge m730:ImportoTotale								
source	<pre><xs:element name="CedolareSecondaRataTrattenerere" type="m730:Importo_730-4" minOccurs="0"/></pre>								

element **ImportiTrattenerere730-4/ContribSolidTrattenerere**

diagram									
namespace	urn:www.agenziaentrate.gov.it:specificheTecniche:sco:730:v1								
type	m730:Importo_730-4								
properties	<table border="0"> <tr><td>isRef</td><td>0</td></tr> <tr><td>minOcc</td><td>0</td></tr> <tr><td>maxOcc</td><td>1</td></tr> <tr><td>content</td><td>complex</td></tr> </table>	isRef	0	minOcc	0	maxOcc	1	content	complex
isRef	0								
minOcc	0								
maxOcc	1								
content	complex								
children	m730:ImportoDichiarante m730:ImportoConiuge m730:ImportoTotale								
source	<pre><xs:element name="ContribSolidTrattenerere" type="m730:Importo_730-4" minOccurs="0"/></pre>								

complexType **Importo_730-4**

diagram	
namespace	urn:www.agenziaentrate.gov.it:specificheTecniche:sco:730:v1
children	m730:ImportoDichiarante m730:ImportoConiuge m730:ImportoTotale
used by	<p>elements</p> <p>ImportiTrattenere730-4/CedolarePrimaRataTrattenere Importi_Rimborsare730-4_Type/CedolareRimborsare ImportiTrattenere730-4/CedolareSecondaRataTrattenere ImportiTrattenere730-4/CedolareTrattenere ImportiTrattenere730-4/ContribSolidTrattenere ImportiTrattenere730-4/AddRegTrattenere/ImportoAddizionale ImportiTrattenere730-4/AddComTrattenere/ImportoAddizionale ImportiTrattenere730-4/AddComAccontoTrattenere/ImportoAddizionale Importi_Rimborsare730-4_Type/AddRegRimborsare/ImportoAddizionale Importi_Rimborsare730-4_Type/AddComRimborsare/ImportoAddizionale ImportiTrattenere730-4/IncrProduTTrattenere ImportiTrattenere730-4/lrpefPrimaRataTrattenere Importi_Rimborsare730-4_Type/lrpefRimborsare ImportiTrattenere730-4/lrpefSecondaRataTrattenere ImportiTrattenere730-4/lrpefTrattenere ImportiTrattenere730-4/TassSepAccontoTrattenere</p>
source	<pre><xs:complexType name="Importo_730-4"> <xs:sequence> <xs:element name="ImportoDichiarante" type="cm:DatoNP_Type" minOccurs="0"/> <xs:element name="ImportoConiuge" type="cm:DatoNP_Type" minOccurs="0"/> <xs:element name="ImportoTotale" type="cm:DatoNP_Type"/> </xs:sequence> </xs:complexType></pre>

element **Importo_730-4/ImportoDichiarante**

diagram							
namespace	urn:www.agenziaentrate.gov.it:specificheTecniche:sco:730:v1						
type	DatoNP_Type						
properties	<p>isRef 0</p> <p>minOcc 0</p> <p>maxOcc 1</p> <p>content simple</p>						
facets	<table border="1"> <thead> <tr> <th>Kind</th> <th>Value</th> <th>annotation</th> </tr> </thead> <tbody> <tr> <td>pattern</td> <td>[1-9]{1}[0-9]*</td> <td></td> </tr> </tbody> </table>	Kind	Value	annotation	pattern	[1-9]{1}[0-9]*	
Kind	Value	annotation					
pattern	[1-9]{1}[0-9]*						
source	<pre><xs:element name="ImportoDichiarante" type="cm:DatoNP_Type" minOccurs="0"/></pre>						

element **Importo_730-4/ImportoConiuge**

diagram	
---------	--

namespace	urn:www.agenziaentrate.gov.it:specificheTecniche:sco:730:v1
type	DatoNP_Type
properties	isRef 0 minOcc 0 maxOcc 1 content simple
facets	Kind Value annotation pattern [1-9]{1}[0-9]*
source	<pre><xs:element name="ImportoConiuge" type="cm:DatoNP_Type" minOccurs="0"/></pre>

element **Importo_730-4/ImportoTotale**

diagram	
namespace	urn:www.agenziaentrate.gov.it:specificheTecniche:sco:730:v1
type	DatoNP_Type
properties	isRef 0 content simple
facets	Kind Value annotation pattern [1-9]{1}[0-9]*
source	<pre><xs:element name="ImportoTotale" type="cm:DatoNP_Type"/></pre>

complexType **Imposta_Lorda_Type**

diagram	
namespace	urn:www.agenziaentrate.gov.it:specificheTecniche:sco:730:v1
children	m730:RedditoComplessivo m730:DeduzAbPrinc m730:OneriDeducibili m730:RedditoImponibile m730:CompensiAttSport m730:ImportoImpostaLorda
used by	element Primo Modulo PL_Type/ImpostaLorda
source	<pre><xs:complexType name="Imposta_Lorda_Type"> <xs:sequence> <xs:element name="RedditoComplessivo" type="cm:DatoNP_Type" minOccurs="0"/> <xs:element name="DeduzAbPrinc" type="cm:DatoNP_Type" minOccurs="0"/> </xs:sequence> </xs:complexType></pre>

	<pre> <xs:element name="OneriDeducibili" type="cm:DatoNP_Type" minOccurs="0"/> <xs:element name="RedditoImponibile" type="cm:DatoNP_Type" minOccurs="0"/> <xs:element name="CompensiAttSport" type="cm:DatoNP_Type" minOccurs="0"/> <xs:element name="ImportoImpostaLorda" type="cm:DatoNP_Type" minOccurs="0"/> </xs:sequence> </xs:complexType> </pre>
--	--

element Imposta_Lorda_Type/RedditoComplessivo

diagram									
namespace	urn:www.agenziaentrate.gov.it:specificheTecniche:sco:730:v1								
type	DatoNP_Type								
properties	<table border="0"> <tr><td>isRef</td><td>0</td></tr> <tr><td>minOcc</td><td>0</td></tr> <tr><td>maxOcc</td><td>1</td></tr> <tr><td>content</td><td>simple</td></tr> </table>	isRef	0	minOcc	0	maxOcc	1	content	simple
isRef	0								
minOcc	0								
maxOcc	1								
content	simple								
facets	<table border="0"> <tr><td>Kind</td><td>Value</td><td>annotation</td></tr> <tr><td>pattern</td><td>[1-9]{1}[0-9]*</td><td></td></tr> </table>	Kind	Value	annotation	pattern	[1-9]{1}[0-9]*			
Kind	Value	annotation							
pattern	[1-9]{1}[0-9]*								
source	<pre><xs:element name="RedditoComplessivo" type="cm:DatoNP_Type" minOccurs="0"/></pre>								

element Imposta_Lorda_Type/DeduzAbPrinc

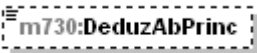
diagram									
namespace	urn:www.agenziaentrate.gov.it:specificheTecniche:sco:730:v1								
type	DatoNP_Type								
properties	<table border="0"> <tr><td>isRef</td><td>0</td></tr> <tr><td>minOcc</td><td>0</td></tr> <tr><td>maxOcc</td><td>1</td></tr> <tr><td>content</td><td>simple</td></tr> </table>	isRef	0	minOcc	0	maxOcc	1	content	simple
isRef	0								
minOcc	0								
maxOcc	1								
content	simple								
facets	<table border="0"> <tr><td>Kind</td><td>Value</td><td>annotation</td></tr> <tr><td>pattern</td><td>[1-9]{1}[0-9]*</td><td></td></tr> </table>	Kind	Value	annotation	pattern	[1-9]{1}[0-9]*			
Kind	Value	annotation							
pattern	[1-9]{1}[0-9]*								
source	<pre><xs:element name="DeduzAbPrinc" type="cm:DatoNP_Type" minOccurs="0"/></pre>								

element Imposta_Lorda_Type/OneriDeducibili

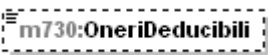
diagram	
namespace	urn:www.agenziaentrate.gov.it:specificheTecniche:sco:730:v1

type	DatoNP_Type
properties	isRef 0 minOcc 0 maxOcc 1 content simple
facets	Kind Value annotation pattern [1-9]{1}[0-9]*
source	<pre><xs:element name="OneriDeducibili" type="cm:DatoNP_Type" minOccurs="0"/></pre>

element Imposta_Lorda_Type/RedditolImponibile

diagram	
namespace	urn:www.agenziaentrate.gov.it:specificheTecniche:sco:730:v1
type	DatoNP_Type
properties	isRef 0 minOcc 0 maxOcc 1 content simple
facets	Kind Value annotation pattern [1-9]{1}[0-9]*
source	<pre><xs:element name="RedditolImponibile" type="cm:DatoNP_Type" minOccurs="0"/></pre>

element Imposta_Lorda_Type/CompensiAttSport

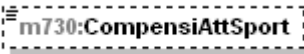
diagram	
namespace	urn:www.agenziaentrate.gov.it:specificheTecniche:sco:730:v1
type	DatoNP_Type
properties	isRef 0 minOcc 0 maxOcc 1 content simple
facets	Kind Value annotation pattern [1-9]{1}[0-9]*
source	<pre><xs:element name="CompensiAttSport" type="cm:DatoNP_Type" minOccurs="0"/></pre>

element Imposta_Lorda_Type/ImportolImpostaLorda

diagram	
namespace	urn:www.agenziaentrate.gov.it:specificheTecniche:sco:730:v1
type	DatoNP_Type
properties	isRef 0 minOcc 0

	maxOcc 1 content simple
facets	Kind Value annotation pattern [1-9]{1}[0-9]*
source	<code><xs:element name="ImportoImpostaLorda" type="cm:DatoNP_Type" minOccurs="0"/></code>

complexType Imposta_Netta_Type

diagram	
namespace	urn:www.agenziaentrate.gov.it:specificheTecniche:sco:730:v1
children	m730:ImportoImpostaNetta m730:CredAltriSisma m730:CredAbitazSisma m730:CredImpEstere m730:CredCanNonPerc m730:Ritenute m730:Differenza m730:Eccedenzalrpef m730:AccontiVersati m730:RestituzioneBonus
used by	element Primo Modulo PL_Type/ImpostaNetta
source	<pre> <xs:complexType name="Imposta_Netta_Type"> <xs:sequence> <xs:element name="ImportoImpostaNetta" type="cm:DatoNP_Type" minOccurs="0"/> <xs:element name="CredAltriSisma" type="cm:DatoNP_Type" minOccurs="0"/> <xs:element name="CredAbitazSisma" type="cm:DatoNP_Type" minOccurs="0"/> <xs:element name="CredImpEstere" type="cm:DatoNP_Type" minOccurs="0"/> <xs:element name="CredCanNonPerc" type="cm:DatoNP_Type" minOccurs="0"/> <xs:element name="Ritenute" type="cm:DatoNP_Type" minOccurs="0"/> </xs:sequence> </xs:complexType> </pre>

	<pre> <xs:element name="Differenza" type="cm:DatoNP_Type" minOccurs="0"/> <xs:element name="EccedenzaIrpef" type="cm:DatoNP_Type" minOccurs="0"/> <xs:element name="AccontiVersati" type="cm:DatoNP_Type" minOccurs="0"/> <xs:element name="RestituzioneBonus" type="cm:DatoNP_Type" minOccurs="0"/> </xs:sequence> </xs:complexType> </pre>
--	--

element **Imposta_Netta_Type/ImportoImpostaNetta**

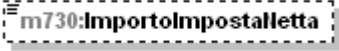
diagram									
namespace	urn:www.agenziaentrate.gov.it:specificheTecniche:sco:730:v1								
type	DatoNP_Type								
properties	<table border="0"> <tr><td>isRef</td><td>0</td></tr> <tr><td>minOcc</td><td>0</td></tr> <tr><td>maxOcc</td><td>1</td></tr> <tr><td>content</td><td>simple</td></tr> </table>	isRef	0	minOcc	0	maxOcc	1	content	simple
isRef	0								
minOcc	0								
maxOcc	1								
content	simple								
facets	<table border="0"> <tr><td>Kind</td><td>Value</td><td>annotation</td></tr> <tr><td>pattern</td><td>[1-9]{1}[0-9]*</td><td></td></tr> </table>	Kind	Value	annotation	pattern	[1-9]{1}[0-9]*			
Kind	Value	annotation							
pattern	[1-9]{1}[0-9]*								
source	<pre><xs:element name="ImportoImpostaNetta" type="cm:DatoNP_Type" minOccurs="0"/></pre>								

element **Imposta_Netta_Type/CredAltriSisma**

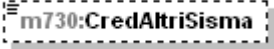
diagram									
namespace	urn:www.agenziaentrate.gov.it:specificheTecniche:sco:730:v1								
type	DatoNP_Type								
properties	<table border="0"> <tr><td>isRef</td><td>0</td></tr> <tr><td>minOcc</td><td>0</td></tr> <tr><td>maxOcc</td><td>1</td></tr> <tr><td>content</td><td>simple</td></tr> </table>	isRef	0	minOcc	0	maxOcc	1	content	simple
isRef	0								
minOcc	0								
maxOcc	1								
content	simple								
facets	<table border="0"> <tr><td>Kind</td><td>Value</td><td>annotation</td></tr> <tr><td>pattern</td><td>[1-9]{1}[0-9]*</td><td></td></tr> </table>	Kind	Value	annotation	pattern	[1-9]{1}[0-9]*			
Kind	Value	annotation							
pattern	[1-9]{1}[0-9]*								
source	<pre><xs:element name="CredAltriSisma" type="cm:DatoNP_Type" minOccurs="0"/></pre>								

element **Imposta_Netta_Type/CredAbitazSisma**

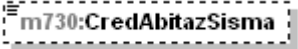
diagram	
namespace	urn:www.agenziaentrate.gov.it:specificheTecniche:sco:730:v1

type	DatoNP_Type
properties	isRef 0 minOcc 0 maxOcc 1 content simple
facets	Kind Value annotation pattern [1-9]{1}[0-9]*
source	<pre><xs:element name="CredAbitazSisma" type="cm:DatoNP_Type" minOccurs="0"/></pre>

element Imposta_Netta_Type/CredImpEstere

diagram	
namespace	urn:www.agenziaentrate.gov.it:specificheTecniche:sco:730:v1
type	DatoNP_Type
properties	isRef 0 minOcc 0 maxOcc 1 content simple
facets	Kind Value annotation pattern [1-9]{1}[0-9]*
source	<pre><xs:element name="CredImpEstere" type="cm:DatoNP_Type" minOccurs="0"/></pre>

element Imposta_Netta_Type/CredCanNonPerc

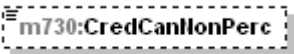
diagram	
namespace	urn:www.agenziaentrate.gov.it:specificheTecniche:sco:730:v1
type	DatoNP_Type
properties	isRef 0 minOcc 0 maxOcc 1 content simple
facets	Kind Value annotation pattern [1-9]{1}[0-9]*
source	<pre><xs:element name="CredCanNonPerc" type="cm:DatoNP_Type" minOccurs="0"/></pre>

element Imposta_Netta_Type/Ritenute

diagram	
namespace	urn:www.agenziaentrate.gov.it:specificheTecniche:sco:730:v1
type	DatoNP_Type
properties	isRef 0 minOcc 0

	maxOcc 1 content simple
facets	Kind Value annotation pattern [1-9]{1}[0-9]*
source	<code><xs:element name="Ritenute" type="cm:DatoNP_Type" minOccurs="0"/></code>

element **Imposta_Netta_Type/Differenza**

diagram	
namespace	urn:www.agenziaentrate.gov.it:specificheTecniche:sco:730:v1
type	DatoNP_Type
properties	isRef 0 minOcc 0 maxOcc 1 content simple
facets	Kind Value annotation pattern [1-9]{1}[0-9]*
source	<code><xs:element name="Differenza" type="cm:DatoNP_Type" minOccurs="0"/></code>

element **Imposta_Netta_Type/EccedenzaIrpef**

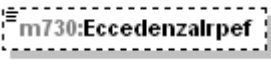
diagram	
namespace	urn:www.agenziaentrate.gov.it:specificheTecniche:sco:730:v1
type	DatoNP_Type
properties	isRef 0 minOcc 0 maxOcc 1 content simple
facets	Kind Value annotation pattern [1-9]{1}[0-9]*
source	<code><xs:element name="EccedenzaIrpef" type="cm:DatoNP_Type" minOccurs="0"/></code>

element **Imposta_Netta_Type/AccontiVersati**

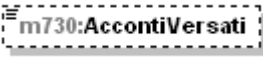
diagram	
namespace	urn:www.agenziaentrate.gov.it:specificheTecniche:sco:730:v1
type	DatoNP_Type
properties	isRef 0 minOcc 0 maxOcc 1 content simple
facets	Kind Value annotation

	pattern [1-9]{1}[0-9]*
source	<code><xs:element name="AccontiVersati" type="cm:DatoNP_Type" minOccurs="0"/></code>

element **Imposta_Netta_Type/RestituzioneBonus**

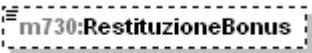
diagram	
namespace	urn:www.agenziaentrate.gov.it:specificheTecniche:sco:730:v1
type	DatoNP_Type
properties	isRef 0 minOcc 0 maxOcc 1 content simple
facets	Kind Value annotation pattern [1-9]{1}[0-9]*
source	<code><xs:element name="RestituzioneBonus" type="cm:DatoNP_Type" minOccurs="0"/></code>

complexType **Imposte_Rimborsate_Type**

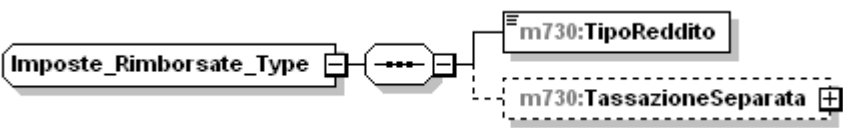
diagram	
namespace	urn:www.agenziaentrate.gov.it:specificheTecniche:sco:730:v1
children	m730:TipoReddito m730:TassazioneSeparata
used by	element Redditi_Tassazione_Separata_Type/ImposteRimborsate
source	<code><xs:complexType name="Imposte_Rimborsate_Type"> <xs:sequence> <xs:element name="TipoReddito" type="m730:Tipo_Reddito_Da1a8_Type"/> <xs:element name="TassazioneSeparata" type="m730:Tassazione_Separata_Type" minOccurs="0"/> </xs:sequence> </xs:complexType></code>

element **Imposte_Rimborsate_Type/TipoReddito**

diagram	
namespace	urn:www.agenziaentrate.gov.it:specificheTecniche:sco:730:v1
type	m730:Tipo_Reddito_Da1a8_Type
properties	isRef 0 content simple

facets	Kind	Value	annotation
	maxLength	2	
	pattern	[1-9]{1}[0-9]*	
	enumeration	1	
	enumeration	2	
	enumeration	3	
	enumeration	4	
	enumeration	5	
	enumeration	6	
enumeration	7		
enumeration	8		
source	<pre><xs:element name="TipoReddito" type="m730:Tipo_Reddito_Dala8_Type"/></pre>		

element **Imposte_Rimborsate_Type/TassazioneSeparata**

diagram	
namespace	urn:www.agenziaentrate.gov.it:specificheTecniche:sco:730:v1
type	m730:Tassazione_Separata_Type
properties	isRef 0 minOcc 0 maxOcc 1 content complex
children	m730:Opzione m730:Anno m730:RedditoRitenute
source	<pre><xs:element name="TassazioneSeparata" type="m730:Tassazione_Separata_Type" minOccurs="0"/></pre>

complexType **Incremento_Produttivita_Type**

diagram	
namespace	urn:www.agenziaentrate.gov.it:specificheTecniche:sco:730:v1
children	m730:ImportoTassazOrdinaria m730:ImportoImpostaSostitutiva m730:RitenuteImpostaSostitutiva m730:Art51Ordinaria m730:Art51Sostitutiva m730:TassazOrdinaria m730:TassazSostitutiva
used by	element Primo Modulo Lavoro Dip Type/IncrementoProduttivita
source	<pre> <xs:complexType name="Incremento_Produttivita_Type"> <xs:sequence> <xs:element name="ImportoTassazOrdinaria" type="cm:DatoNP_Type" minOccurs="0"/> <xs:element name="ImportoImpostaSostitutiva" type="cm:DatoNP_Type" minOccurs="0"/> <xs:element name="RitenuteImpostaSostitutiva" type="cm:DatoNP_Type" minOccurs="0"/> <xs:element name="Art51Ordinaria" type="cm:DatoNP_Type" minOccurs="0"/> <xs:element name="Art51Sostitutiva" type="cm:DatoNP_Type" minOccurs="0"/> <xs:choice minOccurs="0"> <xs:element name="TassazOrdinaria" type="cm:DatoCB_Type"/> <xs:element name="TassazSostitutiva" type="cm:DatoCB_Type"/> </xs:choice> </xs:sequence> </xs:complexType> </pre>

element **Incremento_Produttivita_Type/ImportoTassazOrdinaria**

diagram	
namespace	urn:www.agenziaentrate.gov.it:specificheTecniche:sco:730:v1
type	DatoNP_Type

properties	isRef 0 minOcc 0 maxOcc 1 content simple
facets	Kind Value annotation pattern [1-9]{1}[0-9]*
source	<code><xs:element name="ImportoTassazOrdinaria" type="cm:DatoNP_Type" minOccurs="0"/></code>

element Incremento_Produttivita_Type/ImportoImpostaSostitutiva

diagram	
namespace	urn:www.agenziaentrate.gov.it:specificheTecniche:sco:730:v1
type	DatoNP_Type
properties	isRef 0 minOcc 0 maxOcc 1 content simple
facets	Kind Value annotation pattern [1-9]{1}[0-9]*
source	<code><xs:element name="ImportoImpostaSostitutiva" type="cm:DatoNP_Type" minOccurs="0"/></code>

element Incremento_Produttivita_Type/RitenuteImpostaSostitutiva

diagram	
namespace	urn:www.agenziaentrate.gov.it:specificheTecniche:sco:730:v1
type	DatoNP_Type
properties	isRef 0 minOcc 0 maxOcc 1 content simple
facets	Kind Value annotation pattern [1-9]{1}[0-9]*
source	<code><xs:element name="RitenuteImpostaSostitutiva" type="cm:DatoNP_Type" minOccurs="0"/></code>

element Incremento_Produttivita_Type/Art51Ordinaria

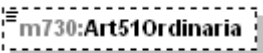
diagram	
namespace	urn:www.agenziaentrate.gov.it:specificheTecniche:sco:730:v1
type	DatoNP_Type
properties	isRef 0 minOcc 0 maxOcc 1

	content simple
facets	Kind Value annotation pattern [1-9]{1}[0-9]*
source	<code><xs:element name="Art51Ordinaria" type="cm:DatoNP_Type" minOccurs="0"/></code>

element Incremento_Produttivita_Type/Art51Sostitutiva

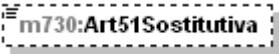
diagram	
namespace	urn:www.agenziaentrate.gov.it:specificheTecniche:sco:730:v1
type	DatoNP_Type
properties	isRef 0 minOcc 0 maxOcc 1 content simple
facets	Kind Value annotation pattern [1-9]{1}[0-9]*
source	<code><xs:element name="Art51Sostitutiva" type="cm:DatoNP_Type" minOccurs="0"/></code>

element Incremento_Produttivita_Type/TassazOrdinaria

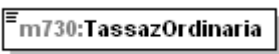
diagram	
namespace	urn:www.agenziaentrate.gov.it:specificheTecniche:sco:730:v1
type	DatoCB_Type
properties	isRef 0 content simple
facets	Kind Value annotation pattern [01]
source	<code><xs:element name="TassazOrdinaria" type="cm:DatoCB_Type"/></code>

element Incremento_Produttivita_Type/TassazSostitutiva

diagram	
namespace	urn:www.agenziaentrate.gov.it:specificheTecniche:sco:730:v1
type	DatoCB_Type
properties	isRef 0 content simple
facets	Kind Value annotation pattern [01]
source	<code><xs:element name="TassazSostitutiva" type="cm:DatoCB_Type"/></code>

complexType Inquilini_Abitazione_Principale_Type

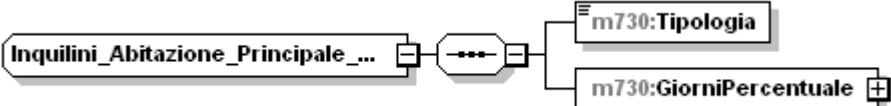
diagram	
namespace	urn:www.agenziaentrate.gov.it:specificheTecniche:sco:730:v1
children	m730:Tipologia m730:GiorniPercentuale
used by	element Detrazioni_Canoni_Locazione_Type/InquiliniAbitazionePrincipale
source	<pre><xs:complexType name="Inquilini_Abitazione_Principale_Type"> <xs:sequence> <xs:element name="Tipologia" type="m730:Tipo_Inquilino_Type"/> <xs:element name="GiorniPercentuale" type="m730:Giorni_Percentuale_Type"/> </xs:sequence> </xs:complexType></pre>

element Inquilini_Abitazione_Principale_Type/Tipologia

diagram																
namespace	urn:www.agenziaentrate.gov.it:specificheTecniche:sco:730:v1															
type	m730:Tipo_Inquilino_Type															
properties	isRef 0 content simple															
facets	<table border="0"> <tr> <td>Kind</td> <td>Value</td> <td>annotation</td> </tr> <tr> <td>pattern</td> <td>[1-9]{1}[0-9]*</td> <td></td> </tr> <tr> <td>enumeration</td> <td>1</td> <td></td> </tr> <tr> <td>enumeration</td> <td>2</td> <td></td> </tr> <tr> <td>enumeration</td> <td>3</td> <td></td> </tr> </table>	Kind	Value	annotation	pattern	[1-9]{1}[0-9]*		enumeration	1		enumeration	2		enumeration	3	
Kind	Value	annotation														
pattern	[1-9]{1}[0-9]*															
enumeration	1															
enumeration	2															
enumeration	3															
source	<pre><xs:element name="Tipologia" type="m730:Tipo_Inquilino_Type"/></pre>															

element Inquilini_Abitazione_Principale_Type/GiorniPercentuale

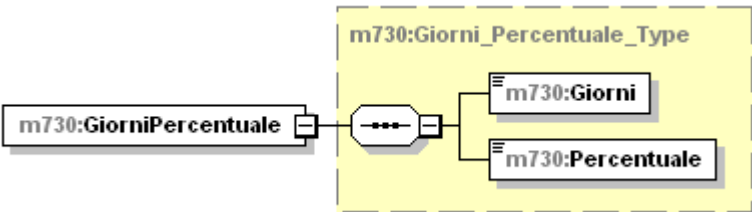
diagram	
namespace	urn:www.agenziaentrate.gov.it:specificheTecniche:sco:730:v1
type	m730:Giorni_Percentuale_Type

properties	isRef 0 content complex
children	m730:Giorni m730:Percentuale
source	<pre><xs:element name="GiorniPercentuale" type="m730:Giorni_Percentuale_Type"/></pre>

complexType Intervento_Ricupero_Patrimonio_Edilizio_Type

diagram	
namespace	urn:www.agenziaentrate.gov.it:specificheTecniche:sco:730:v1
children	m730:Anno m730:Periodo2006 m730:CodiceFiscale m730:CasellaVedereIstruzioni m730:CodiceSituazioniParticolari m730:AnnoSituazioniParticolari m730:RideterminazioneRate m730:IRate m730:Spesa m730:NOrdineImmobile
used by	elements PrimoModulo_Oneri_Type/InterventoRecuperoPatrimonioEdilizio Modulo_Oneri_Type/InterventoRecuperoPatrimonioEdilizio
source	<pre><xs:complexType name="Intervento_Ricupero_Patrimonio_Edilizio_Type"> <xs:sequence> <!--<xs:element name="Anno" type="cm:DatoDA_Type" minOccurs="0"/>--> <xs:element name="Anno" type="m730:Anno_Ricupero_Patrimonio_Edilizio_Type"/> <xs:element name="Periodo2006" type="m730:Periodo_2006_Type" minOccurs="0"/> <xs:element name="CodiceFiscale" type="cm:DatoCF_Type" minOccurs="0"/> <xs:element name="CasellaVedereIstruzioni" type="m730:Casella_Istruzioni_Type" minOccurs="0"/> <xs:element name="CodiceSituazioniParticolari" type="m730:Casella_Codice_Type" minOccurs="0"/> </xs:sequence> </xs:complexType></pre>

	<pre> <xs:element name="AnnoSituazioniParticolari" type="m730:Anno_Patrimonio_Edilizio_Situazioni_Particolari_Type" minOccurs="0"/> <xs:element name="RideterminazioneRate" type="m730:Rideterminazione_Rate_Type" minOccurs="0"/> <xs:element name="NRate" type="m730:N_Rate_Type"/> <xs:element name="Spesa" type="cm:DatoNP_Type"/> <xs:element name="NOrdineImmobile" type="cm:DatoNP_Type" minOccurs="0"/> </xs:sequence> </xs:complexType> </pre>
--	---

element Intervento_Ricupero_Patrimonio_Edilizio_Type/Anno

diagram																																					
namespace	urn:www.agenziaentrate.gov.it:specificheTecniche:sco:730:v1																																				
type	m730:Anno Ricupero Patrimonio Edilizio_Type																																				
properties	isRef 0 content simple																																				
facets	<table border="0"> <tr> <td>Kind</td> <td>Value</td> <td>annotation</td> </tr> <tr> <td>pattern</td> <td>[1-9]{1}[0-9]*</td> <td></td> </tr> <tr> <td>enumeration</td> <td>2002</td> <td></td> </tr> <tr> <td>enumeration</td> <td>2003</td> <td></td> </tr> <tr> <td>enumeration</td> <td>2004</td> <td></td> </tr> <tr> <td>enumeration</td> <td>2005</td> <td></td> </tr> <tr> <td>enumeration</td> <td>2006</td> <td></td> </tr> <tr> <td>enumeration</td> <td>2007</td> <td></td> </tr> <tr> <td>enumeration</td> <td>2008</td> <td></td> </tr> <tr> <td>enumeration</td> <td>2009</td> <td></td> </tr> <tr> <td>enumeration</td> <td>2010</td> <td></td> </tr> <tr> <td>enumeration</td> <td>2011</td> <td></td> </tr> </table>	Kind	Value	annotation	pattern	[1-9]{1}[0-9]*		enumeration	2002		enumeration	2003		enumeration	2004		enumeration	2005		enumeration	2006		enumeration	2007		enumeration	2008		enumeration	2009		enumeration	2010		enumeration	2011	
Kind	Value	annotation																																			
pattern	[1-9]{1}[0-9]*																																				
enumeration	2002																																				
enumeration	2003																																				
enumeration	2004																																				
enumeration	2005																																				
enumeration	2006																																				
enumeration	2007																																				
enumeration	2008																																				
enumeration	2009																																				
enumeration	2010																																				
enumeration	2011																																				
source	<pre> <xs:element name="Anno" type="m730:Anno_Ricupero_Patrimonio_Edilizio_Type"/> </pre>																																				

element Intervento_Ricupero_Patrimonio_Edilizio_Type/Periodo2006

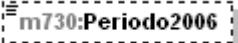
diagram							
namespace	urn:www.agenziaentrate.gov.it:specificheTecniche:sco:730:v1						
type	m730:Periodo_2006_Type						
properties	isRef 0 minOcc 0 maxOcc 1 content simple						
facets	<table border="0"> <tr> <td>Kind</td> <td>Value</td> <td>annotation</td> </tr> <tr> <td>maxLength</td> <td>1</td> <td></td> </tr> </table>	Kind	Value	annotation	maxLength	1	
Kind	Value	annotation					
maxLength	1						

	pattern [1-9] enumeration 1 enumeration 2
source	<pre><xs:element name="Periodo2006" type="m730:Periodo_2006_Type" minOccurs="0"/></pre>

element **Intervento_Ricupero_Patrimonio_Edilizio_Type/CodiceFiscale**

diagram	
namespace	urn:www.agenziaentrate.gov.it:specificheTecniche:sco:730:v1
type	DatoCF_Type
properties	isRef 0 minOcc 0 maxOcc 1 content simple
facets	Kind Value annotation pattern [0-9]{11}[A-Z]{6}[0-9LMNPQRSTUUV]{2}[A-Z]{1}[0-9LMNPQRSTUUV]{2}[A-Z]{1}[0-9LMNPQRSTUUV]{3}[A-Z]{1}
source	<pre><xs:element name="CodiceFiscale" type="cm:DatoCF_Type" minOccurs="0"/></pre>

element **Intervento_Ricupero_Patrimonio_Edilizio_Type/CasellaVedereIstruzioni**

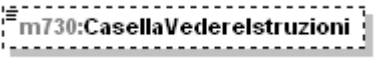
diagram																						
namespace	urn:www.agenziaentrate.gov.it:specificheTecniche:sco:730:v1																					
type	m730:Casella_Istruzioni_Type																					
properties	isRef 0 minOcc 0 maxOcc 1 content simple																					
facets	<table border="0"> <tr> <td>Kind</td> <td>Value</td> <td>annotation</td> </tr> <tr> <td>maxLength</td> <td>1</td> <td></td> </tr> <tr> <td>pattern</td> <td>[1-9]</td> <td></td> </tr> <tr> <td>enumeration</td> <td>1</td> <td></td> </tr> <tr> <td>enumeration</td> <td>2</td> <td></td> </tr> <tr> <td>enumeration</td> <td>3</td> <td></td> </tr> <tr> <td>enumeration</td> <td>4</td> <td></td> </tr> </table>	Kind	Value	annotation	maxLength	1		pattern	[1-9]		enumeration	1		enumeration	2		enumeration	3		enumeration	4	
Kind	Value	annotation																				
maxLength	1																					
pattern	[1-9]																					
enumeration	1																					
enumeration	2																					
enumeration	3																					
enumeration	4																					
source	<pre><xs:element name="CasellaVedereIstruzioni" type="m730:Casella_Istruzioni_Type" minOccurs="0"/></pre>																					

element **Intervento_Ricupero_Patrimonio_Edilizio_Type/CodiceSituazioniParticolari**

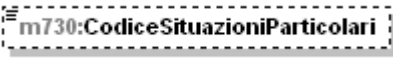
diagram	
namespace	urn:www.agenziaentrate.gov.it:specificheTecniche:sco:730:v1

type	m730:Casella Codice Type
properties	isRef 0 minOcc 0 maxOcc 1 content simple
facets	Kind Value annotation maxLength 1 pattern [1-9] enumeration 1 enumeration 2 enumeration 3 enumeration 4
source	<pre><xs:element name="CodiceSituazioniParticolari" type="m730:Casella_Codice_Type" minOccurs="0"/></pre>

element **Intervento_Ricupero_Patrimonio_Edilizio_Type/AnnoSituazioniParticolari**

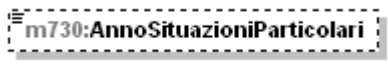
diagram	
namespace	urn:www.agenziaentrate.gov.it:specificheTecniche:sco:730:v1
type	m730:Anno Patrimonio Edilizio Situazioni Particolari Type
properties	isRef 0 minOcc 0 maxOcc 1 content simple
facets	Kind Value annotation pattern [1-9]{1}[0-9]* enumeration 2007 enumeration 2008 enumeration 2009 enumeration 2010 enumeration 2011
source	<pre><xs:element name="AnnoSituazioniParticolari" type="m730:Anno_Patrimonio_Edilizio_Situazioni_Particolari_Type" minOccurs="0"/></pre>

element **Intervento_Ricupero_Patrimonio_Edilizio_Type/RideterminazioneRate**

diagram	
namespace	urn:www.agenziaentrate.gov.it:specificheTecniche:sco:730:v1
type	m730:Rideterminazione Rate Type
properties	isRef 0 minOcc 0 maxOcc 1 content simple
facets	Kind Value annotation pattern [1-9]{1}[0-9]*

	enumeration 5 enumeration 10
source	<code><xs:element name="RideterminazioneRate" type="m730:Rideterminazione_Rate_Type" minOccurs="0"/></code>

element `Intervento_Ricupero_Patrimonio_Edilizio_Type/NRate`

diagram	
namespace	urn:www.agenziaentrate.gov.it:specificheTecniche:sco:730:v1
type	m730:N_Rate_Type
properties	isRef 0 content complex
children	m730:Rate3 m730:Rate5 m730:Rate10
source	<code><xs:element name="NRate" type="m730:N_Rate_Type"/></code>

element `Intervento_Ricupero_Patrimonio_Edilizio_Type/Spesa`

diagram	
namespace	urn:www.agenziaentrate.gov.it:specificheTecniche:sco:730:v1
type	DatoNP_Type
properties	isRef 0 content simple
facets	Kind Value annotation pattern [1-9]{1}[0-9]*
source	<code><xs:element name="Spesa" type="cm:DatoNP_Type"/></code>

element `Intervento_Ricupero_Patrimonio_Edilizio_Type/NOrdineImmobile`

diagram	
namespace	urn:www.agenziaentrate.gov.it:specificheTecniche:sco:730:v1
type	DatoNP_Type
properties	isRef 0 minOcc 0 maxOcc 1 content simple
facets	Kind Value annotation

	pattern [1-9]{1}[0-9]*
source	<code><xs:element name="NOrdineImmobile" type="cm:DatoNP_Type" minOccurs="0"/></code>

complexType **Intervento_Risparmio_Energetico_Type**

diagram	
namespace	urn:www.agenziaentrate.gov.it:specificheTecniche:sco:730:v1
children	m730:TipoIntervento m730:Anno m730:CasiParticolari m730:RideterminazioneRate m730:RipartizioneRate m730:NumeroRata m730:Spesa
used by	elements PrimoModulo_Oneri_Type/InterventoRisparmioEnergetico Modulo_Oneri_Type/InterventoRisparmioEnergetico
source	<pre><xs:complexType name="Intervento_Risparmio_Energetico_Type"> <xs:sequence> <xs:element name="TipoIntervento" type="m730:Tipo_Intervento_Type"/> <xs:element name="Anno" type="m730:Anno_Risparmio_Energetico_Type"/> <xs:element name="CasiParticolari" type="m730:Casi_Particolari_Risp_Ener_Type" minOccurs="0"/> <xs:element name="RideterminazioneRate" type="m730:Rate_Risparmio_Energetico_Type" minOccurs="0"/> <xs:element name="RipartizioneRate" type="m730:Ripart_Risparmio_Energetico_Type"/> <xs:element name="NumeroRata" type="m730:Numero_Rata_Risparmi_Energetico_Type"/> <xs:element name="Spesa" type="cm:DatoNP_Type"/> </xs:sequence> </xs:complexType></pre>

element **Intervento_Risparmio_Energetico_Type/TipolIntervento**

diagram	
---------	--

namespace	urn:www.agenziaentrate.gov.it:specificheTecniche:sco:730:v1																					
type	m730:Tipo_Intervento_Type																					
properties	isRef 0 content simple																					
facets	<table border="1"> <thead> <tr> <th>Kind</th> <th>Value</th> <th>annotation</th> </tr> </thead> <tbody> <tr> <td>maxLength</td> <td>1</td> <td></td> </tr> <tr> <td>pattern</td> <td>[1-9]</td> <td></td> </tr> <tr> <td>enumeration</td> <td>1</td> <td></td> </tr> <tr> <td>enumeration</td> <td>2</td> <td></td> </tr> <tr> <td>enumeration</td> <td>3</td> <td></td> </tr> <tr> <td>enumeration</td> <td>4</td> <td></td> </tr> </tbody> </table>	Kind	Value	annotation	maxLength	1		pattern	[1-9]		enumeration	1		enumeration	2		enumeration	3		enumeration	4	
Kind	Value	annotation																				
maxLength	1																					
pattern	[1-9]																					
enumeration	1																					
enumeration	2																					
enumeration	3																					
enumeration	4																					
source	<pre><xs:element name="TipoIntervento" type="m730:Tipo_Intervento_Type"/></pre>																					

element `Intervento_Risparmio_Energetico_Type/Anno`

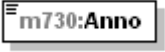
diagram																			
namespace	urn:www.agenziaentrate.gov.it:specificheTecniche:sco:730:v1																		
type	m730:Anno Risparmio Energetico_Type																		
properties	isRef 0 content simple																		
facets	<table border="1"> <thead> <tr> <th>Kind</th> <th>Value</th> <th>annotation</th> </tr> </thead> <tbody> <tr> <td>pattern</td> <td>[1-9]{1}[0-9]*</td> <td></td> </tr> <tr> <td>enumeration</td> <td>2008</td> <td></td> </tr> <tr> <td>enumeration</td> <td>2009</td> <td></td> </tr> <tr> <td>enumeration</td> <td>2010</td> <td></td> </tr> <tr> <td>enumeration</td> <td>2011</td> <td></td> </tr> </tbody> </table>	Kind	Value	annotation	pattern	[1-9]{1}[0-9]*		enumeration	2008		enumeration	2009		enumeration	2010		enumeration	2011	
Kind	Value	annotation																	
pattern	[1-9]{1}[0-9]*																		
enumeration	2008																		
enumeration	2009																		
enumeration	2010																		
enumeration	2011																		
source	<pre><xs:element name="Anno" type="m730:Anno_Risparmio_Energetico_Type"/></pre>																		

element `Intervento_Risparmio_Energetico_Type/CasiParticolari`

diagram																			
namespace	urn:www.agenziaentrate.gov.it:specificheTecniche:sco:730:v1																		
type	m730:Casi Particolari Risp Ener_Type																		
properties	isRef 0 minOcc 0 maxOcc 1 content simple																		
facets	<table border="1"> <thead> <tr> <th>Kind</th> <th>Value</th> <th>annotation</th> </tr> </thead> <tbody> <tr> <td>maxLength</td> <td>1</td> <td></td> </tr> <tr> <td>pattern</td> <td>[1-9]</td> <td></td> </tr> <tr> <td>enumeration</td> <td>1</td> <td></td> </tr> <tr> <td>enumeration</td> <td>2</td> <td></td> </tr> <tr> <td>enumeration</td> <td>3</td> <td></td> </tr> </tbody> </table>	Kind	Value	annotation	maxLength	1		pattern	[1-9]		enumeration	1		enumeration	2		enumeration	3	
Kind	Value	annotation																	
maxLength	1																		
pattern	[1-9]																		
enumeration	1																		
enumeration	2																		
enumeration	3																		

source	<pre><xs:element name="CasiParticolari" type="m730:Casi_Particolari_Risp_Ener_Type" minOccurs="0"/></pre>
--------	---

element **Intervento_Risparmio_Energetico_Type/RideterminazioneRate**

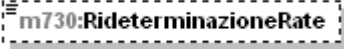
diagram																															
namespace	urn:www.agenziaentrate.gov.it:specificheTecniche:sco:730:v1																														
type	m730:Rate_Risparmio_Energetico_Type																														
properties	<table border="0"> <tr><td>isRef</td><td>0</td></tr> <tr><td>minOcc</td><td>0</td></tr> <tr><td>maxOcc</td><td>1</td></tr> <tr><td>content</td><td>simple</td></tr> </table>	isRef	0	minOcc	0	maxOcc	1	content	simple																						
isRef	0																														
minOcc	0																														
maxOcc	1																														
content	simple																														
facets	<table border="0"> <thead> <tr> <th>Kind</th> <th>Value</th> <th>annotation</th> </tr> </thead> <tbody> <tr><td>pattern</td><td>[1-9]{1}[0-9]*</td><td></td></tr> <tr><td>enumeration</td><td>3</td><td></td></tr> <tr><td>enumeration</td><td>4</td><td></td></tr> <tr><td>enumeration</td><td>5</td><td></td></tr> <tr><td>enumeration</td><td>6</td><td></td></tr> <tr><td>enumeration</td><td>7</td><td></td></tr> <tr><td>enumeration</td><td>8</td><td></td></tr> <tr><td>enumeration</td><td>9</td><td></td></tr> <tr><td>enumeration</td><td>10</td><td></td></tr> </tbody> </table>	Kind	Value	annotation	pattern	[1-9]{1}[0-9]*		enumeration	3		enumeration	4		enumeration	5		enumeration	6		enumeration	7		enumeration	8		enumeration	9		enumeration	10	
Kind	Value	annotation																													
pattern	[1-9]{1}[0-9]*																														
enumeration	3																														
enumeration	4																														
enumeration	5																														
enumeration	6																														
enumeration	7																														
enumeration	8																														
enumeration	9																														
enumeration	10																														
source	<pre><xs:element name="RideterminazioneRate" type="m730:Rate_Risparmio_Energetico_Type" minOccurs="0"/></pre>																														

element **Intervento_Risparmio_Energetico_Type/RipartizioneRate**

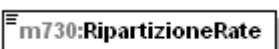
diagram																												
namespace	urn:www.agenziaentrate.gov.it:specificheTecniche:sco:730:v1																											
type	m730:Ripart_Risparmio_Energetico_Type																											
properties	<table border="0"> <tr><td>isRef</td><td>0</td></tr> <tr><td>content</td><td>simple</td></tr> </table>	isRef	0	content	simple																							
isRef	0																											
content	simple																											
facets	<table border="0"> <thead> <tr> <th>Kind</th> <th>Value</th> <th>annotation</th> </tr> </thead> <tbody> <tr><td>pattern</td><td>[1-9]{1}[0-9]*</td><td></td></tr> <tr><td>enumeration</td><td>4</td><td></td></tr> <tr><td>enumeration</td><td>5</td><td></td></tr> <tr><td>enumeration</td><td>6</td><td></td></tr> <tr><td>enumeration</td><td>7</td><td></td></tr> <tr><td>enumeration</td><td>8</td><td></td></tr> <tr><td>enumeration</td><td>9</td><td></td></tr> <tr><td>enumeration</td><td>10</td><td></td></tr> </tbody> </table>	Kind	Value	annotation	pattern	[1-9]{1}[0-9]*		enumeration	4		enumeration	5		enumeration	6		enumeration	7		enumeration	8		enumeration	9		enumeration	10	
Kind	Value	annotation																										
pattern	[1-9]{1}[0-9]*																											
enumeration	4																											
enumeration	5																											
enumeration	6																											
enumeration	7																											
enumeration	8																											
enumeration	9																											
enumeration	10																											
source	<pre><xs:element name="RipartizioneRate" type="m730:Ripart_Risparmio_Energetico_Type"/></pre>																											

element `Intervento_Risparmio_Energetico_Type/NumeroRata`

diagram	
namespace	urn:www.agenziaentrate.gov.it:specificheTecniche:sco:730:v1
type	m730:Numero_Rata_Risparmi_Energetico_Type
properties	isRef 0 content simple
facets	Kind Value annotation pattern [1-9]{1}[0-9]* enumeration 1 enumeration 2 enumeration 3 enumeration 4
source	<pre><xs:element name="NumeroRata" type="m730:Numero_Rata_Risparmi_Energetico_Type"/></pre>

element `Intervento_Risparmio_Energetico_Type/Spesa`

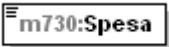
diagram	
namespace	urn:www.agenziaentrate.gov.it:specificheTecniche:sco:730:v1
type	DatoNP_Type
properties	isRef 0 content simple
facets	Kind Value annotation pattern [1-9]{1}[0-9]*
source	<pre><xs:element name="Spesa" type="cm:DatoNP_Type"/></pre>

complexType `Intestazione_730_Type`

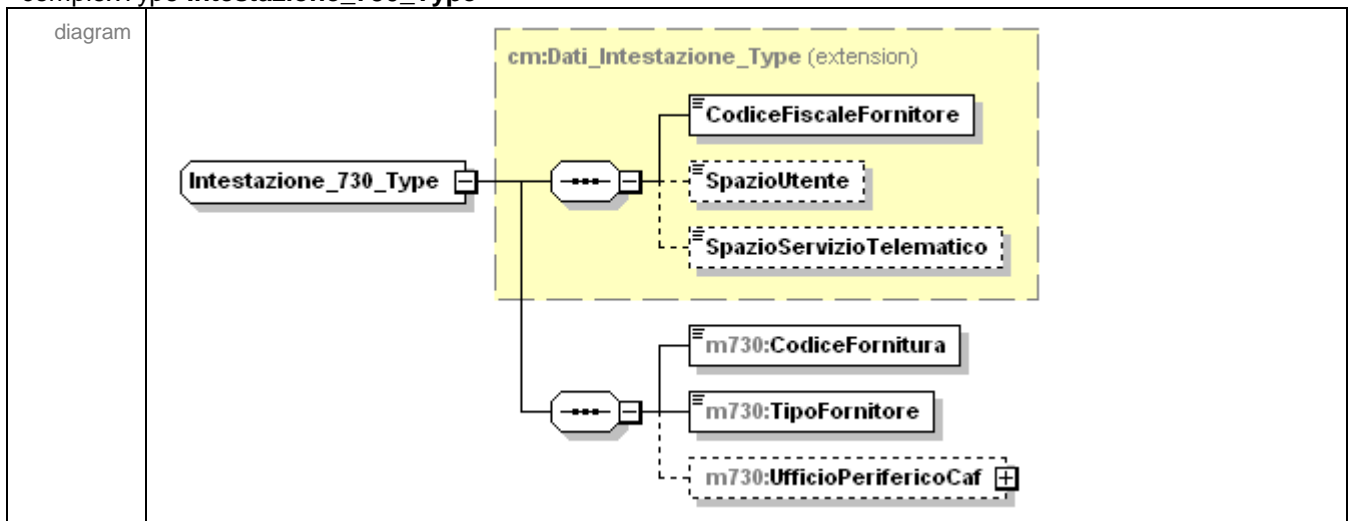

namespace	urn:www.agenziaentrate.gov.it:specificheTecniche:sco:730:v1
type	extension of Dati_Intestazione_Type
properties	base cm:Dati_Intestazione_Type
children	CodiceFiscaleFornitore SpazioUtente SpazioServizioTelematico m730:CodiceFornitura m730:TipoFornitore m730:UfficioPerifericoCaf
used by	element Fornitura/Intestazione
source	<pre> <xs:complexType name="Intestazione_730_Type"> <xs:complexContent> <xs:extension base="cm:Dati_Intestazione_Type"> <xs:sequence> <xs:element name="CodiceFornitura" type="cm:CodiceFornitura_Type" fixed="73012"/> <xs:element name="TipoFornitore" type="m730:Tipo_Fornitore_730_Type"/> <xs:element name="UfficioPerifericoCaf" type="sc:Domicilio_Ita_Type" minOccurs="0"/> <!-- Domicilio_Ita_Type ha il codice comune che non probabilmente, se l'elemento è effettivamente necessario, andrebbe create un nuovo tipo --> </xs:sequence> </xs:extension> </xs:complexContent> </xs:complexType> </pre>

element Intestazione_730_Type/CodiceFornitura

diagram	
namespace	urn:www.agenziaentrate.gov.it:specificheTecniche:sco:730:v1
type	CodiceFornitura_Type
properties	isRef 0 content simple fixed 73012
facets	Kind Value annotation length 5 pattern [0-9A-Z]{1}([0-9A-Z] \. \& _ s / ^ \(\))*
source	<pre> <xs:element name="CodiceFornitura" type="cm:CodiceFornitura_Type" fixed="73012"/> </pre>

element Intestazione_730_Type/TipoFornitore

diagram	
namespace	urn:www.agenziaentrate.gov.it:specificheTecniche:sco:730:v1

type	m730:Tipo_Fornitore_730_Type
properties	isRef 0 content simple
facets	Kind Value annotation pattern [1-9]{1}[0-9]* enumeration 1 enumeration 3 enumeration 5 enumeration 6 enumeration 10
source	<pre><xs:element name="TipoFornitore" type="m730:Tipo_Fornitore_730_Type"/></pre>

element Intestazione_730_Type/UfficioPerifericoCaf

diagram	
namespace	urn:www.agenziaentrate.gov.it:specificheTecniche:sco:730:v1
type	Domicilio_Ita_Type
properties	isRef 0 minOcc 0 maxOcc 1 content complex
children	Comune Provincia CodiceComune Indirizzo Cap
source	<pre><xs:element name="UfficioPerifericoCaf" type="sc:Domicilio_Ita_Type" minOccurs="0"/></pre>

complexType Lavoro_Dipendente_Type

diagram	
namespace	urn:www.agenziaentrate.gov.it:specificheTecniche:sco:730:v1

children	m730:TipologiaReddito m730:TipoContratto m730:Reddito
used by	elements Primo Modulo Lavoro Dip Type/LavoroDipendente Modulo Lavoro Dip Type/LavoroDipendente
source	<pre><xs:complexType name="Lavoro_Dipendente_Type"> <xs:sequence> <xs:element name="TipologiaReddito" type="m730:Tipo_Reddito_Da1a3_Type"/> <xs:element name="TipoContratto" type="m730:Indeterminato_Determinato_Type" minOccurs="0"/> <xs:element name="Reddito" type="cm:DatoNP_Type"/> </xs:sequence> </xs:complexType></pre>

element Lavoro_Dipendente_Type/TipologiaReddito

diagram																			
namespace	urn:www.agenziaentrate.gov.it:specificheTecniche:sco:730:v1																		
type	m730:Tipo_Reddito_Da1a3_Type																		
properties	isRef 0 content simple																		
facets	<table border="1"> <thead> <tr> <th>Kind</th> <th>Value</th> <th>annotation</th> </tr> </thead> <tbody> <tr> <td>maxLength</td> <td>1</td> <td></td> </tr> <tr> <td>pattern</td> <td>[1-9]</td> <td></td> </tr> <tr> <td>enumeration</td> <td>1</td> <td></td> </tr> <tr> <td>enumeration</td> <td>2</td> <td></td> </tr> <tr> <td>enumeration</td> <td>3</td> <td></td> </tr> </tbody> </table>	Kind	Value	annotation	maxLength	1		pattern	[1-9]		enumeration	1		enumeration	2		enumeration	3	
Kind	Value	annotation																	
maxLength	1																		
pattern	[1-9]																		
enumeration	1																		
enumeration	2																		
enumeration	3																		
source	<pre><xs:element name="TipologiaReddito" type="m730:Tipo_Reddito_Da1a3_Type"/></pre>																		

element Lavoro_Dipendente_Type/TipoContratto

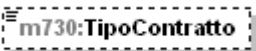
diagram																
namespace	urn:www.agenziaentrate.gov.it:specificheTecniche:sco:730:v1															
type	m730:Indeterminato_Determinato_Type															
properties	isRef 0 minOcc 0 maxOcc 1 content simple															
facets	<table border="1"> <thead> <tr> <th>Kind</th> <th>Value</th> <th>annotation</th> </tr> </thead> <tbody> <tr> <td>maxLength</td> <td>1</td> <td></td> </tr> <tr> <td>pattern</td> <td>[1-9]</td> <td></td> </tr> <tr> <td>enumeration</td> <td>1</td> <td></td> </tr> <tr> <td>enumeration</td> <td>2</td> <td></td> </tr> </tbody> </table>	Kind	Value	annotation	maxLength	1		pattern	[1-9]		enumeration	1		enumeration	2	
Kind	Value	annotation														
maxLength	1															
pattern	[1-9]															
enumeration	1															
enumeration	2															
source	<pre><xs:element name="TipoContratto"</pre>															

```
type="m730:Indeterminato_Determinato_Type" minOccurs="0"/>
```

element Lavoro_Dipendente_Type/Reddito

diagram	
namespace	urn:www.agenziaentrate.gov.it:specificheTecniche:sco:730:v1
type	DatoNP_Type
properties	isRef 0 content simple
facets	Kind Value annotation pattern [1-9]{1}[0-9]*
source	<pre><xs:element name="Reddito" type="cm:DatoNP_Type"/></pre>

complexType Misura_Acconti_Type

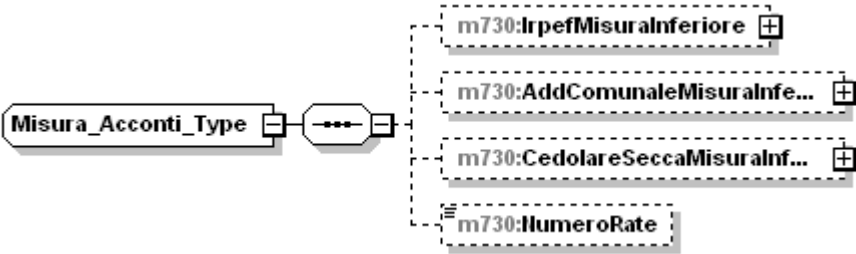
diagram	
namespace	urn:www.agenziaentrate.gov.it:specificheTecniche:sco:730:v1
children	m730:IrpefMisuraInferiore m730:AddComunaleMisuraInferiore m730:CedolareSeccaMisuraInferiore m730:NumeroRate
used by	element Primo Modulo Acconti Ritenute Type/MisuraAcconti
source	<pre><xs:complexType name="Misura_Acconti_Type"> <xs:sequence> <xs:element name="IrpefMisuraInferiore" type="m730:Casella_Acconto_Type" minOccurs="0"/> <xs:element name="AddComunaleMisuraInferiore" type="m730:Casella_Acconto_Type" minOccurs="0"/> <xs:element name="CedolareSeccaMisuraInferiore" type="m730:Casella_Acconto_Type" minOccurs="0"/> <xs:element name="NumeroRate" type="m730:Numero_RateDa2A5_Type" minOccurs="0"/> </xs:sequence> </xs:complexType></pre>

element **Misura_Acconti_Type/IrpefMisuraInferiore**

diagram	
namespace	urn:www.agenziaentrate.gov.it:specificheTecniche:sco:730:v1
type	m730:Casella_Acconto_Type
properties	isRef 0 minOcc 0 maxOcc 1 content complex
children	m730:Casella m730:ImportoMisuraInferiore
source	<pre><xs:element name="IrpefMisuraInferiore" type="m730:Casella_Acconto_Type" minOccurs="0"/></pre>

element **Misura_Acconti_Type/AddComunaleMisuraInferiore**

diagram	
namespace	urn:www.agenziaentrate.gov.it:specificheTecniche:sco:730:v1
type	m730:Casella_Acconto_Type
properties	isRef 0 minOcc 0 maxOcc 1 content complex
children	m730:Casella m730:ImportoMisuraInferiore
source	<pre><xs:element name="AddComunaleMisuraInferiore" type="m730:Casella_Acconto_Type" minOccurs="0"/></pre>

element **Misura_Acconti_Type/CedolareSeccaMisuraInferiore**

diagram	
namespace	urn:www.agenziaentrate.gov.it:specificheTecniche:sco:730:v1

type	m730:Casella_Acconto_Type
properties	isRef 0 minOcc 0 maxOcc 1 content complex
children	m730:Casella m730:ImportoMisuraInferiore
source	<pre><xs:element name="CedolareSeccaMisuraInferiore" type="m730:Casella_Acconto_Type" minOccurs="0"/></pre>

element Misura_Aconti_Type/NumeroRate

diagram	
namespace	urn:www.agenziaentrate.gov.it:specificheTecniche:sco:730:v1
type	m730:Numero_RateDa2A5_Type
properties	isRef 0 minOcc 0 maxOcc 1 content simple
facets	Kind Value annotation length 1 pattern [1-9]{1}[0-9]* enumeration 2 enumeration 3 enumeration 4 enumeration 5
source	<pre><xs:element name="NumeroRate" type="m730:Numero_RateDa2A5_Type" minOccurs="0"/></pre>

complexType Modulo_Altri_Reddito_Type

diagram	
namespace	urn:www.agenziaentrate.gov.it:specificheTecniche:sco:730:v1
children	m730:RedditiDiCapitale m730:RedditiTassazioneSeparata
used by	element Altri_Reddito_Type/Modulo
source	<pre><xs:complexType name="Modulo_Altri_Reddito_Type"> <xs:sequence> <xs:element name="RedditiDiCapitale" type="m730:Redditi_Capitale_Type" minOccurs="0"/> <xs:element name="RedditiTassazioneSeparata" type="m730:Redditi_Tassazione_Separata_Type" minOccurs="0"/> </xs:sequence> </xs:complexType></pre>

element **Modulo_Altri_Reddito_Type/RedditiDiCapitale**

diagram	
namespace	urn:www.agenziaentrate.gov.it:specificheTecniche:sco:730:v1
type	m730:Redditi_Capitale_Type
properties	isRef 0 minOcc 0 maxOcc 1 content complex
children	m730:Utili m730:AltriRedditiDiCapitale m730:LavoroAutonomo m730:RedditiDiversi m730:RedditiDiversiDetraz
source	<pre><xs:element name="RedditiDiCapitale" type="m730:Redditi_Capitale_Type" minOccurs="0"/></pre>

element **Modulo_Altri_Reddito_Type/RedditiTassazioneSeparata**

diagram	
namespace	urn:www.agenziaentrate.gov.it:specificheTecniche:sco:730:v1
type	m730:Redditi_Tassazione_Separata_Type
properties	isRef 0 minOcc 0 maxOcc 1 content complex
children	m730:RedditiErede m730:ImposteRimborsate
source	<pre><xs:element name="RedditiTassazioneSeparata" type="m730:Redditi_Tassazione_Separata_Type" minOccurs="0"/></pre>

complexType **Modulo_Crediti_Imposta_Type**

diagram	
namespace	urn:www.agenziaentrate.gov.it:specificheTecniche:sco:730:v1
children	m730:CreditoImpostaFondiPensione m730:CreditoImpostaRedditiEsteri m730:CreditoPrimaCasaSismaAbruzzo m730:CreditoAltriSismaAbruzzo
used by	element Crediti_Imposta/Modulo
source	<pre> <xs:complexType name="Modulo_Crediti_Imposta_Type"> <xs:sequence> <xs:element name="CreditoImpostaFondiPensione" type="m730:Credito_Imposta_Fondi_Pensione_Type" minOccurs="0"/> <xs:element name="CreditoImpostaRedditiEsteri" type="m730:Credito_Imposta_Redditi_Esteri_Type" minOccurs="0"/> <xs:element name="CreditoPrimaCasaSismaAbruzzo" type="m730:Credito_Immibile_Sisma_Abruzzo_Type" minOccurs="0"/> <xs:element name="CreditoAltriSismaAbruzzo" type="m730:Credito_Imposta_Altri_Sisma_Abruzzo_Type" minOccurs="0"/> </xs:sequence> </xs:complexType> </pre>

element **Modulo_Crediti_Imposta_Type/CreditoImpostaFondiPensione**

diagram	
namespace	urn:www.agenziaentrate.gov.it:specificheTecniche:sco:730:v1
type	m730:Credito_Imposta_Fondi_Pensione_Type
properties	isRef 0 minOcc 0

	maxOcc 1 content complex
children	m730:AnnoAnticipazione m730:Reintegro m730:SommaReintegrata m730:CreditoAnno
source	<pre><xs:element name="CreditiImpostaFondiPensione" type="m730:Crediti_Imposta_Fondi_Pensione_Type" minOccurs="0"/></pre>

element **Modulo_Crediti_Imposta_Type/CreditImpostaRedditiEsteri**

diagram	
namespace	urn:www.agenziaentrate.gov.it:specificheTecniche:sco:730:v1
type	m730:Crediti_Imposta_Redditi_Esteri_Type
properties	isRef 0 minOcc 0 maxOcc 1 content complex
children	m730:StatoEsterio m730:Anno m730:RedditoEsterio m730:ImpostaEsteria m730:RedditoComplessivo m730:Imposta_Lorda m730:ImpostaNetta m730:CreditoDichiarazioniPrecedenti m730:DiCuiStatoEsterio
source	<pre><xs:element name="CreditiImpostaRedditiEsteri" type="m730:Crediti_Imposta_Redditi_Esteri_Type" minOccurs="0"/></pre>

element **Modulo_Crediti_Imposta_Type/CreditoPrimaCasaSismaAbruzzo**

diagram									
namespace	urn:www.agenziaentrate.gov.it:specificheTecniche:sco:730:v1								
type	m730:Credito_Immibile_Sisma_Abruzzo_Type								
properties	<table border="0"> <tr><td>isRef</td><td>0</td></tr> <tr><td>minOcc</td><td>0</td></tr> <tr><td>maxOcc</td><td>1</td></tr> <tr><td>content</td><td>complex</td></tr> </table>	isRef	0	minOcc	0	maxOcc	1	content	complex
isRef	0								
minOcc	0								
maxOcc	1								
content	complex								
children	m730:CodiceFiscale m730:NumeroRata m730:TotaleCredito								
source	<pre><xs:element name="CreditoPrimaCasaSismaAbruzzo" type="m730:Credito_Immibile_Sisma_Abruzzo_Type" minOccurs="0"/></pre>								

element **Modulo_Crediti_Imposta_Type/CreditoAltriSismaAbruzzo**

diagram									
namespace	urn:www.agenziaentrate.gov.it:specificheTecniche:sco:730:v1								
type	m730:Crediti_Imposta_Altri_Sisma_Abruzzo_Type								
properties	<table border="0"> <tr><td>isRef</td><td>0</td></tr> <tr><td>minOcc</td><td>0</td></tr> <tr><td>maxOcc</td><td>1</td></tr> <tr><td>content</td><td>complex</td></tr> </table>	isRef	0	minOcc	0	maxOcc	1	content	complex
isRef	0								
minOcc	0								
maxOcc	1								
content	complex								
children	m730:Impresa_Professione m730:CreditoImmibileSismaAbruzzo m730:Rateazione								
source	<pre><xs:element name="CreditoAltriSismaAbruzzo" type="m730:Crediti_Imposta_Altri_Sisma_Abruzzo_Type" minOccurs="0"/></pre>								

complexType **Modulo_Fabbricato_Type**

diagram	
namespace	urn:www.agenziaentrate.gov.it:specificheTecniche:sco:730:v1
children	m730:FabbricatoOrd m730:FabbricatoAgev
used by	element Redditi_Fabbricati_Type/Modulo
source	<pre> <xs:complexType name="Modulo_Fabbricato_Type"> <xs:sequence> <xs:element name="FabbricatoOrd" type="m730:FabbricatoOrd_Type" maxOccurs="10"/> <xs:element name="FabbricatoAgev" type="m730:FabbricatoAgev_Type" minOccurs="0" maxOccurs="4"/> </xs:sequence> </xs:complexType> </pre>

element **Modulo_Fabbricato_Type/FabbricatoOrd**

diagram	
namespace	urn:www.agenziaentrate.gov.it:specificheTecniche:sco:730:v1

type	m730:FabbricatoOrd_Type
properties	isRef 0 minOcc 1 maxOcc 10 content complex
children	m730:Rendita m730:Utilizzo m730:GiorniPossesso m730:PercPossesso m730:CodiceCanone m730:CanoneLocazione m730:CasiParticolari m730:CasellaContinuazione m730:CodiceComune m730:IciDovuta m730:OpzioneCedolare
source	<pre><xs:element name="FabbricatoOrd" type="m730:FabbricatoOrd_Type" maxOccurs="10"/></pre>

element Modulo_Fabbricato_Type/FabbricatoAgev

diagram	
namespace	urn:www.agenziaentrate.gov.it:specificheTecniche:sco:730:v1
type	m730:FabbricatoAgev_Type
properties	isRef 0 minOcc 0 maxOcc 4 content complex
children	m730:NumeroRigoRiferimento m730:NumModuloRiferimento m730:DatiContratto m730:CasellaInf30Giorni m730:AnnoDichiarazioneIci
source	<pre><xs:element name="FabbricatoAgev" type="m730:FabbricatoAgev_Type" minOccurs="0" maxOccurs="4"/></pre>

complexType Modulo_Familiari_Type

diagram	
namespace	urn:www.agenziaentrate.gov.it:specificheTecniche:sco:730:v1
children	m730:Coniuge m730:PrimoFiglio m730:Familiari

used by	elements Familiari_Type/Modulo Familiari_Type/PrimoModulo
source	<pre> <xs:complexType name="Modulo_Familiari_Type"> <xs:sequence> <xs:element name="Coniuge" type="m730:Dati_Coniuge_Type" minOccurs="0"/> <xs:element name="PrimoFiglio" minOccurs="0"> <xs:complexType> <xs:complexContent> <xs:extension base="m730:Dati_Familiare_Type"> <xs:sequence> <xs:element name="Tipo"> <xs:simpleType> <xs:restriction base="cm:DatoAN_Type"> <xs:enumeration value="F"/> <xs:enumeration value="D"/> </xs:restriction> </xs:simpleType> </xs:element> </xs:sequence> </xs:extension> </xs:complexContent> </xs:complexType> </xs:element> <xs:element name="Familiari" minOccurs="0" maxOccurs="3"> <xs:complexType> <xs:complexContent> <xs:extension base="m730:Dati_Familiare_Type"> <xs:sequence> <xs:element name="Tipo"> <xs:simpleType> <xs:restriction base="cm:DatoAN_Type"> <xs:enumeration value="F"/> <xs:enumeration value="D"/> <xs:enumeration value="A"/> </xs:restriction> </xs:simpleType> </xs:element> </xs:sequence> </xs:extension> </xs:complexContent> </xs:complexType> </xs:element> </xs:sequence> </xs:complexType> </pre>

element **Modulo_Familiari_Type/Coniuge**

diagram	<p>The diagram illustrates the structure of the <code>m730:Dati_Coniuge_Type</code> complex type. It is shown as a dashed box containing four elements: <code>m730:Coniuge</code>, <code>m730:Tipo</code>, <code>m730:CodiceFiscale</code>, and <code>m730:Mesi</code>. The <code>m730:Coniuge</code> element is connected to a central connector, which then branches out to connect to each of the other three elements.</p>								
namespace	urn:www.agenziaentrate.gov.it:specificheTecniche:sco:730:v1								
type	m730:Dati_Coniuge_Type								
properties	<table border="0"> <tr><td>isRef</td><td>0</td></tr> <tr><td>minOcc</td><td>0</td></tr> <tr><td>maxOcc</td><td>1</td></tr> <tr><td>content</td><td>complex</td></tr> </table>	isRef	0	minOcc	0	maxOcc	1	content	complex
isRef	0								
minOcc	0								
maxOcc	1								
content	complex								
children	m730:Tipo m730:CodiceFiscale m730:Mesi								
source	<code><xs:element name="Coniuge" type="m730:Dati_Coniuge_Type" minOccurs="0"/></code>								

element **Modulo_Familiari_Type/PrimoFiglio**

diagram	<p>The diagram illustrates the structure of the <code>m730:Dati_Familiare_Type (extension)</code> complex type. It is shown as a dashed box containing several elements: <code>m730:PrimoFiglio</code>, <code>m730:CodiceFiscale</code>, <code>m730:Mesi</code>, <code>m730:MesiMinore</code>, <code>m730:PercDetraz</code>, <code>m730:PercDetrazCon</code>, <code>m730:Affidamento</code>, and <code>m730:Tipo</code>. The <code>m730:PrimoFiglio</code> element is connected to a central connector, which then branches out to connect to each of the other seven elements.</p>								
namespace	urn:www.agenziaentrate.gov.it:specificheTecniche:sco:730:v1								
type	extension of m730:Dati_Familiare_Type								
properties	<table border="0"> <tr><td>isRef</td><td>0</td></tr> <tr><td>minOcc</td><td>0</td></tr> <tr><td>maxOcc</td><td>1</td></tr> <tr><td>content</td><td>complex</td></tr> </table>	isRef	0	minOcc	0	maxOcc	1	content	complex
isRef	0								
minOcc	0								
maxOcc	1								
content	complex								
children	m730:CodiceFiscale m730:Mesi m730:MesiMinore m730:PercDetraz m730:PercDetrazCon m730:Affidamento m730:Tipo								
source	<code><xs:element name="PrimoFiglio" minOccurs="0"> <xs:complexType></code>								

	<pre> <xs:complexContent> <xs:extension base="m730:Dati_Familiare_Type"> <xs:sequence> <xs:element name="Tipo"> <xs:simpleType> <xs:restriction base="cm:DatoAN_Type"> <xs:enumeration value="F"/> <xs:enumeration value="D"/> </xs:restriction> </xs:simpleType> </xs:element> </xs:sequence> </xs:extension> </xs:complexContent> </xs:complexType> </xs:element> </pre>
--	--

element Modulo_Familiari_Type/PrimoFiglio/Tipo

diagram													
namespace	urn:www.agenziaentrate.gov.it:specificheTecniche:sco:730:v1												
type	restriction of DatoAN_Type												
properties	isRef 0 content simple												
facets	<table border="0"> <tr> <td>Kind</td> <td>Value</td> <td>annotation</td> </tr> <tr> <td>pattern</td> <td>[0-9A-Z]{1}([0-9A-Z] \- _ \&amp; \s / \^ \(\))*</td> <td></td> </tr> <tr> <td>enumeration</td> <td>F</td> <td></td> </tr> <tr> <td>enumeration</td> <td>D</td> <td></td> </tr> </table>	Kind	Value	annotation	pattern	[0-9A-Z]{1}([0-9A-Z] \- _ \& \s / \^ \(\))*		enumeration	F		enumeration	D	
Kind	Value	annotation											
pattern	[0-9A-Z]{1}([0-9A-Z] \- _ \& \s / \^ \(\))*												
enumeration	F												
enumeration	D												
source	<pre> <xs:element name="Tipo"> <xs:simpleType> <xs:restriction base="cm:DatoAN_Type"> <xs:enumeration value="F"/> <xs:enumeration value="D"/> </xs:restriction> </xs:simpleType> </xs:element> </pre>												

element **Modulo_Familiari_Type/Familiari**

<p>diagram</p>	
<p>namespace</p>	<p>urn:www.agenziaentrate.gov.it:specificheTecniche:sco:730:v1</p>
<p>type</p>	<p>extension of m730:Dati_Familiare_Type</p>
<p>properties</p>	<p>isRef 0 minOcc 0 maxOcc 3 content complex</p>
<p>children</p>	<p>m730:CodiceFiscale m730:Mesi m730:MesiMinore m730:PercDetraz m730:PercDetrazCon m730:Affidamento m730:Tipo</p>
<p>source</p>	<pre><xs:element name="Familiari" minOccurs="0" maxOccurs="3"> <xs:complexType> <xs:complexContent> <xs:extension base="m730:Dati_Familiare_Type"> <xs:sequence> <xs:element name="Tipo"> <xs:simpleType> <xs:restriction base="cm:DatoAN_Type"> <xs:enumeration value="F"/> <xs:enumeration value="D"/> <xs:enumeration value="A"/> </xs:restriction> </xs:simpleType> </xs:element> </xs:sequence> </xs:extension> </xs:complexContent> </xs:complexType> </xs:element></pre>

element **Modulo_Familiari_Type/Familiari/Tipo**

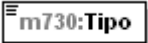
diagram	
namespace	urn:www.agenziaentrate.gov.it:specificheTecniche:sco:730:v1
type	restriction of DatoAN_Type
properties	isRef 0 content simple
facets	Kind Value annotation pattern [0-9A-Z-]{1}([0-9A-Z] \\- \\. & ; \\s / ^ \\(\\))* enumeration F enumeration D enumeration A
source	<pre><xs:element name="Tipo"> <xs:simpleType> <xs:restriction base="cm:DatoAN_Type"> <xs:enumeration value="F"/> <xs:enumeration value="D"/> <xs:enumeration value="A"/> </xs:restriction> </xs:simpleType> </xs:element></pre>

complexType **Modulo_Lavoro_Dip_Type**

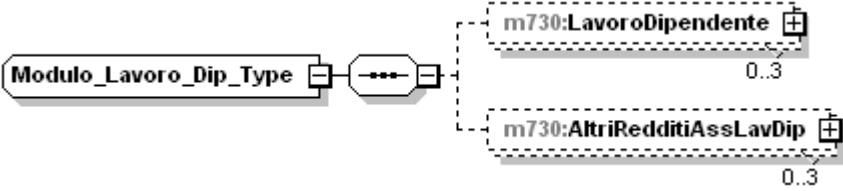
diagram	
namespace	urn:www.agenziaentrate.gov.it:specificheTecniche:sco:730:v1
children	m730:LavoroDipendente m730:AltriRedditiAssLavDip
used by	element Redditi_Lavoro_Dip_Type/Modulo
source	<pre><xs:complexType name="Modulo_Lavoro_Dip_Type"> <xs:sequence> <xs:element name="LavoroDipendente" type="m730:Lavoro_Dipendente_Type" minOccurs="0" maxOccurs="3"/> <xs:element name="AltriRedditiAssLavDip" type="m730:Altri_Redditi_Ass_Lavd_Type" minOccurs="0" maxOccurs="3"/> </xs:sequence> </xs:complexType></pre>

element **Modulo_Lavoro_Dip_Type/LavoroDipendente**

diagram									
namespace	urn:www.agenziaentrate.gov.it:specificheTecniche:sco:730:v1								
type	m730:Lavoro_Dipendente_Type								
properties	<table> <tr><td>isRef</td><td>0</td></tr> <tr><td>minOcc</td><td>0</td></tr> <tr><td>maxOcc</td><td>3</td></tr> <tr><td>content</td><td>complex</td></tr> </table>	isRef	0	minOcc	0	maxOcc	3	content	complex
isRef	0								
minOcc	0								
maxOcc	3								
content	complex								
children	m730:TipologiaReddito m730:TipoContratto m730:Reddito								
source	<pre><xs:element name="LavoroDipendente" type="m730:Lavoro_Dipendente_Type" minOccurs="0" maxOccurs="3"/></pre>								

element **Modulo_Lavoro_Dip_Type/AltriRedditiAssLavDip**

diagram									
namespace	urn:www.agenziaentrate.gov.it:specificheTecniche:sco:730:v1								
type	m730:Altri_Redditi_Ass_Lavd_Type								
properties	<table> <tr><td>isRef</td><td>0</td></tr> <tr><td>minOcc</td><td>0</td></tr> <tr><td>maxOcc</td><td>3</td></tr> <tr><td>content</td><td>complex</td></tr> </table>	isRef	0	minOcc	0	maxOcc	3	content	complex
isRef	0								
minOcc	0								
maxOcc	3								
content	complex								
children	m730:AssegnoDelConiuge m730:ImportoRedditoAssimilato								
source	<pre><xs:element name="AltriRedditiAssLavDip" type="m730:Altri_Redditi_Ass_Lavd_Type" minOccurs="0" maxOccurs="3"/></pre>								

complexType **Modulo_Oneri_Type**

<p>diagram</p>	
<p>namespace</p>	<p>urn:www.agenziaentrate.gov.it:specificheTecniche:sco:730:v1</p>
<p>children</p>	<p>m730:SpeseDetrazioni m730:SpeseDeduzioni m730:InterventoRecuperoPatrimonioEdilizio m730:DatiCatastaliRecuperoPatrimonioEdilizio m730:InterventoRisparmioEnergetico m730:CanoniLocazione m730:DatiAltreDetrazioni</p>
<p>used by</p>	<p>element Oneri_Type/Modulo</p>
<p>source</p>	<pre><xs:complexType name="Modulo_Oneri_Type"> <xs:sequence> <xs:element name="SpeseDetrazioni" type="m730:Detrazioni_Modulo_Type" minOccurs="0"/> <xs:element name="SpeseDeduzioni" type="m730:Deduzioni_Modulo_Type" minOccurs="0"/> <xs:element name="InterventoRecuperoPatrimonioEdilizio" type="m730:Intervento_Ricupero_Patrimonio_Edilizio_Type" minOccurs="0" maxOccurs="4"/> <xs:element name="DatiCatastaliRecuperoPatrimonioEdilizio" type="m730:Sezione_Dati_Catastali_Recupero_Patrimonio_Edilizi o_Type" minOccurs="0"/> <xs:element name="InterventoRisparmioEnergetico" type="m730:Intervento_Risparmio_Energetico_Type" minOccurs="0" maxOccurs="3"/> <xs:element name="CanoniLocazione" type="m730:Detrazioni_Canoni_Locazione_Type" minOccurs="0"/> <xs:element name="DatiAltreDetrazioni" type="m730:Dati_Altre_Detrazioni_Modulo_Type" minOccurs="0"/> </xs:sequence> </xs:complexType></pre>

element **Modulo_Oneri_Type/SpeseDetrazioni**

diagram	
namespace	urn:www.agenziaentrate.gov.it:specificheTecniche:sco:730:v1
type	m730:Detrazioni Modulo Type
properties	isRef 0 minOcc 0 maxOcc 1 content complex
children	m730:VeicoliDisabili m730:AcquistoCaniGuida m730:SpeseRateizzate m730:AttivitaSportiveRagazzi m730:AltreSpese
source	<pre><xs:element name="SpeseDetrazioni" type="m730:Detrazioni_Modulo_Type" minOccurs="0"/></pre>

element **Modulo_Oneri_Type/SpeseDeduzioni**

diagram	
namespace	urn:www.agenziaentrate.gov.it:specificheTecniche:sco:730:v1
type	m730:Deduzioni Modulo Type
properties	isRef 0 minOcc 0 maxOcc 1 content complex
children	m730:AssegnoConiuge m730:AltriOneri
source	<pre><xs:element name="SpeseDeduzioni" type="m730:Deduzioni_Modulo_Type" minOccurs="0"/></pre>

element **Modulo_Oneri_Type/InterventoRecuperoPatrimonioEdilizio**

<p>diagram</p>	
<p>namespace</p>	<p>urn:www.agenziaentrate.gov.it:specificheTecniche:sco:730:v1</p>
<p>type</p>	<p>m730:Intervento Recupero Patrimonio Edilizio Type</p>
<p>properties</p>	<p>isRef 0 minOcc 0 maxOcc 4 content complex</p>
<p>children</p>	<p>m730:Anno m730:Periodo2006 m730:CodiceFiscale m730:CasellaVederelstruzioni m730:CodiceSituazioniParticolari m730:AnnoSituazioniParticolari m730:RideterminazioneRate m730:NRate m730:Spesa m730:NOrdinelImmobile</p>
<p>source</p>	<pre><xs:element name="InterventoRecuperoPatrimonioEdilizio" type="m730:Intervento_Recupero_Patrimonio_Edilizio_Type" minOccurs="0" maxOccurs="4"/></pre>

element **Modulo_Oneri_Type/DatiCatastaliRecuperoPatrimonioEdilizio**

<p>diagram</p>	
<p>namespace</p>	<p>urn:www.agenziaentrate.gov.it:specificheTecniche:sco:730:v1</p>
<p>type</p>	<p>m730:Sezione Dati Catastali Recupero Patrimonio Edilizio Type</p>

properties	isRef 0 minOcc 0 maxOcc 1 content complex
children	m730:DatiCatastaliRecuperoPatrimonioEdilizio m730:DatiRegistrazioneAccatastamentoRecuperoPatrimonio_Edilizio
source	<pre><xs:element name="DatiCatastaliRecuperoPatrimonioEdilizio" type="m730:Sezione_Dati_Catastali_Recupero_Patrimonio_Edilizi o_Type" minOccurs="0"/></pre>

element Modulo_Oneri_Type/InterventoRisparmioEnergetico

diagram	
namespace	urn:www.agenziaentrate.gov.it:specificheTecniche:sco:730:v1
type	m730:Intervento_Risparmio_Energetico_Type
properties	isRef 0 minOcc 0 maxOcc 3 content complex
children	m730:TipoIntervento m730:Anno m730:CasiParticolari m730:RideterminazioneRate m730:RipartizioneRate m730:NumeroRata m730:Spesa
source	<pre><xs:element name="InterventoRisparmioEnergetico" type="m730:Intervento_Risparmio_Energetico_Type" minOccurs="0" maxOccurs="3"/></pre>

element Modulo_Oneri_Type/CanoniLocazione

diagram	
---------	--

namespace	urn:www.agenziaentrate.gov.it:specificheTecniche:sco:730:v1
type	m730:Detrazioni Canoni Locazione Type
properties	isRef 0 minOcc 0 maxOcc 1 content complex
children	m730:InquiliniAbitazionePrincipale m730:DipendentiTrasferiti
source	<pre><xs:element name="CanoniLocazione" type="m730:Detrazioni_Canoni_Locazione_Type" minOccurs="0"/></pre>

element **Modulo_Oneri_Type/DatiAltreDetrazioni**

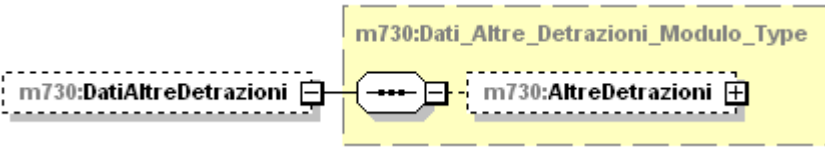
diagram	
namespace	urn:www.agenziaentrate.gov.it:specificheTecniche:sco:730:v1
type	m730:Dati Altre Detrazioni Modulo Type
properties	isRef 0 minOcc 0 maxOcc 1 content complex
children	m730:AltreDetrazioni
source	<pre><xs:element name="DatiAltreDetrazioni" type="m730:Dati_Altre_Detrazioni_Modulo_Type" minOccurs="0"/></pre>

complexType **Modulo_PL_Type**

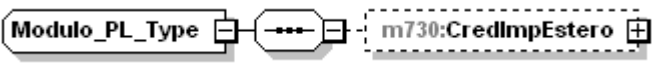
diagram	
namespace	urn:www.agenziaentrate.gov.it:specificheTecniche:sco:730:v1
children	m730:CredImpEsterio
used by	element Prospetto Liquidazione Type/Modulo
source	<pre><xs:complexType name="Modulo_PL_Type"> <xs:sequence> <xs:element name="CredImpEsterio" type="m730:Cred_Imp_Esterio_Type" minOccurs="0"/> </xs:sequence> </xs:complexType></pre>

element **Modulo_PL_Type/CredImpEstero**

diagram									
namespace	urn:www.agenziaentrate.gov.it:specificheTecniche:sco:730:v1								
type	m730:Cred_Imp_Estero_Type								
properties	<table border="0"> <tr><td>isRef</td><td>0</td></tr> <tr><td>minOcc</td><td>0</td></tr> <tr><td>maxOcc</td><td>1</td></tr> <tr><td>content</td><td>complex</td></tr> </table>	isRef	0	minOcc	0	maxOcc	1	content	complex
isRef	0								
minOcc	0								
maxOcc	1								
content	complex								
children	m730:Anno m730:TotCredito m730:CreditoStato								
source	<pre><xs:element name="CredImpEstero" type="m730:Cred_Imp_Estero_Type" minOccurs="0"/></pre>								

complexType **Modulo_Terreno_Type**

diagram	
namespace	urn:www.agenziaentrate.gov.it:specificheTecniche:sco:730:v1
children	m730:Terreno
used by	element Redditi_Terreni_Type/Modulo
source	<pre><xs:complexType name="Modulo_Terreno_Type"> <xs:sequence> <xs:element name="Terreno" type="m730:Terreno_Type" maxOccurs="8"/> </xs:sequence> </xs:complexType></pre>

element **Modulo_Terreno_Type/Terreno**

diagram	
namespace	urn:www.agenziaentrate.gov.it:specificheTecniche:sco:730:v1
type	m730:Terreno_Type
properties	isRef 0 minOcc 1 maxOcc 8 content complex
children	m730:RedDominicale m730:Titolo m730:RedAgrario m730:GiorniPossesso m730:PercPossesso m730:CanoneVincolistico m730:CasiParticolari m730:CasellaContinuazione
source	<pre><xs:element name="Terreno" type="m730:Terreno_Type" maxOccurs="8"/></pre>

complexType **N_Rate_Type**

diagram	
namespace	urn:www.agenziaentrate.gov.it:specificheTecniche:sco:730:v1
children	m730:Rate3 m730:Rate5 m730:Rate10
used by	element Intervento_Ricupero_Patrimonio_Edilizio_Type/NRate
source	<pre><xs:complexType name="N_Rate_Type"> <xs:choice> <xs:element name="Rate3" type="m730:Rate3_Type" minOccurs="0"/> <xs:element name="Rate5" type="m730:Rate5_Type" minOccurs="0"/> </xs:choice> </xs:complexType></pre>

	<pre> <xs:element name="Rate10" type="m730:Rate10_Type" minOccurs="0"/> </xs:choice> </xs:complexType> </pre>
--	---

element N_Rate_Type/Rate3

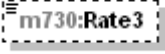
diagram																
namespace	urn:www.agenziaentrate.gov.it:specificheTecniche:sco:730:v1															
type	m730:Rate3_Type															
properties	isRef 0 minOcc 0 maxOcc 1 content simple															
facets	<table border="1"> <thead> <tr> <th>Kind</th> <th>Value</th> <th>annotation</th> </tr> </thead> <tbody> <tr> <td>pattern</td> <td>[1-9]{1}[0-9]*</td> <td></td> </tr> <tr> <td>enumeration</td> <td>1</td> <td></td> </tr> <tr> <td>enumeration</td> <td>2</td> <td></td> </tr> <tr> <td>enumeration</td> <td>3</td> <td></td> </tr> </tbody> </table>	Kind	Value	annotation	pattern	[1-9]{1}[0-9]*		enumeration	1		enumeration	2		enumeration	3	
Kind	Value	annotation														
pattern	[1-9]{1}[0-9]*															
enumeration	1															
enumeration	2															
enumeration	3															
source	<pre> <xs:element name="Rate3" type="m730:Rate3_Type" minOccurs="0"/> </pre>															

element N_Rate_Type/Rate5

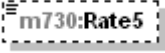
diagram																						
namespace	urn:www.agenziaentrate.gov.it:specificheTecniche:sco:730:v1																					
type	m730:Rate5_Type																					
properties	isRef 0 minOcc 0 maxOcc 1 content simple																					
facets	<table border="1"> <thead> <tr> <th>Kind</th> <th>Value</th> <th>annotation</th> </tr> </thead> <tbody> <tr> <td>pattern</td> <td>[1-9]{1}[0-9]*</td> <td></td> </tr> <tr> <td>enumeration</td> <td>1</td> <td></td> </tr> <tr> <td>enumeration</td> <td>2</td> <td></td> </tr> <tr> <td>enumeration</td> <td>3</td> <td></td> </tr> <tr> <td>enumeration</td> <td>4</td> <td></td> </tr> <tr> <td>enumeration</td> <td>5</td> <td></td> </tr> </tbody> </table>	Kind	Value	annotation	pattern	[1-9]{1}[0-9]*		enumeration	1		enumeration	2		enumeration	3		enumeration	4		enumeration	5	
Kind	Value	annotation																				
pattern	[1-9]{1}[0-9]*																					
enumeration	1																					
enumeration	2																					
enumeration	3																					
enumeration	4																					
enumeration	5																					
source	<pre> <xs:element name="Rate5" type="m730:Rate5_Type" minOccurs="0"/> </pre>																					

element N_Rate_Type/Rate10

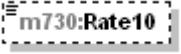
diagram																																					
namespace	urn:www.agenziaentrate.gov.it:specificheTecniche:sco:730:v1																																				
type	m730:Rate10_Type																																				
properties	isRef 0 minOcc 0 maxOcc 1 content simple																																				
facets	<table border="1"> <thead> <tr> <th>Kind</th> <th>Value</th> <th>annotation</th> </tr> </thead> <tbody> <tr> <td>pattern</td> <td>[1-9]{1}[0-9]*</td> <td></td> </tr> <tr> <td>enumeration</td> <td>1</td> <td></td> </tr> <tr> <td>enumeration</td> <td>2</td> <td></td> </tr> <tr> <td>enumeration</td> <td>3</td> <td></td> </tr> <tr> <td>enumeration</td> <td>4</td> <td></td> </tr> <tr> <td>enumeration</td> <td>5</td> <td></td> </tr> <tr> <td>enumeration</td> <td>6</td> <td></td> </tr> <tr> <td>enumeration</td> <td>7</td> <td></td> </tr> <tr> <td>enumeration</td> <td>8</td> <td></td> </tr> <tr> <td>enumeration</td> <td>9</td> <td></td> </tr> <tr> <td>enumeration</td> <td>10</td> <td></td> </tr> </tbody> </table>	Kind	Value	annotation	pattern	[1-9]{1}[0-9]*		enumeration	1		enumeration	2		enumeration	3		enumeration	4		enumeration	5		enumeration	6		enumeration	7		enumeration	8		enumeration	9		enumeration	10	
Kind	Value	annotation																																			
pattern	[1-9]{1}[0-9]*																																				
enumeration	1																																				
enumeration	2																																				
enumeration	3																																				
enumeration	4																																				
enumeration	5																																				
enumeration	6																																				
enumeration	7																																				
enumeration	8																																				
enumeration	9																																				
enumeration	10																																				
source	<pre><xs:element name="Rate10" type="m730:Rate10_Type" minOccurs="0"/></pre>																																				

complexType Oneri_Type

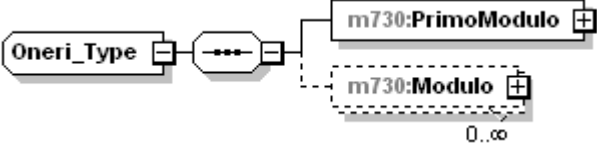
diagram	
namespace	urn:www.agenziaentrate.gov.it:specificheTecniche:sco:730:v1
children	m730:PrimoModulo m730:Modulo
used by	element Dati Contabili Type/QuadroE
source	<pre><xs:complexType name="Oneri_Type"> <xs:sequence> <xs:element name="PrimoModulo" type="m730:PrimoModulo_Oneri_Type"/> <xs:element name="Modulo" type="m730:Modulo_Oneri_Type" minOccurs="0" maxOccurs="unbounded"/> </xs:sequence> </xs:complexType></pre>

element **Oneri_Type/PrimoModulo**

<p>diagram</p>	
<p>namespace</p>	<p>urn:www.agenziaentrate.gov.it:specificheTecniche:sco:730:v1</p>
<p>type</p>	<p>m730:PrimoModulo_Oneri_Type</p>
<p>properties</p>	<p>isRef 0 content complex</p>
<p>children</p>	<p>m730:SpeseDetrazioni m730:SpeseDeduzioni m730:InterventoRecuperoPatrimonioEdilizio m730:DatiCatastaliRecuperoPatrimonioEdilizio m730:InterventoRisparmioEnergetico m730:CanoniLocazione m730:DatiAltreDetrazioni</p>
<p>source</p>	<pre><xs:element name="PrimoModulo" type="m730:PrimoModulo_Oneri_Type"/></pre>

element **Oneri_Type/Modulo**

diagram	
namespace	urn:www.agenziaentrate.gov.it:specificheTecniche:sco:730:v1
type	m730:Modulo_Oneri_Type
properties	isRef 0 minOcc 0 maxOcc unbounded content complex
children	m730:SpeseDetrazioni m730:SpeseDeduzioni m730:InterventoRecuperoPatrimonioEdilizio m730:DatiCatastaliRecuperoPatrimonioEdilizio m730:InterventoRisparmioEnergetico m730:CanoniLocazione m730:DatiAltreDetrazioni
source	<pre><xs:element name="Modulo" type="m730:Modulo_Oneri_Type" minOccurs="0" maxOccurs="unbounded"/></pre>

complexType **Opzione_Produttivita_Type**

diagram	
namespace	urn:www.agenziaentrate.gov.it:specificheTecniche:sco:730:v1
source	<pre><xs:complexType name="Opzione_Produttivita_Type"/></pre>

complexType **Periodo_Di_Lavoro_Type**

diagram	
namespace	urn:www.agenziaentrate.gov.it:specificheTecniche:sco:730:v1
children	m730:GiorniLavoroDipendente m730:GiorniPensione

used by	element Primo Modulo Lavoro Dip Type/PeriodoLavoro
source	<pre><xs:complexType name="Periodo_Di_Lavoro_Type"> <xs:sequence> <xs:element name="GiorniLavoroDipendente" type="cm:DatoGA_Type" minOccurs="0"/> <xs:element name="GiorniPensione" type="cm:DatoGA_Type" minOccurs="0"/> </xs:sequence> </xs:complexType></pre>

element [Periodo_Di_Lavoro_Type/GiorniLavoroDipendente](#)

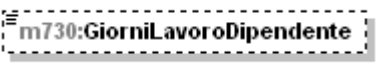
diagram													
namespace	urn:www.agenziaentrate.gov.it:specificheTecniche:sco:730:v1												
type	DatoGA_Type												
properties	<table> <tr><td>isRef</td><td>0</td></tr> <tr><td>minOcc</td><td>0</td></tr> <tr><td>maxOcc</td><td>1</td></tr> <tr><td>content</td><td>simple</td></tr> </table>	isRef	0	minOcc	0	maxOcc	1	content	simple				
isRef	0												
minOcc	0												
maxOcc	1												
content	simple												
facets	<table> <tr><td>Kind</td><td>Value</td><td>annotation</td></tr> <tr><td>minLength</td><td>1</td><td></td></tr> <tr><td>maxLength</td><td>3</td><td></td></tr> <tr><td>pattern</td><td>[1-9]([1-9][0-9])?([12][0-9][0-9])?(3[0-5][0-9])?(36[0-5])?</td><td></td></tr> </table>	Kind	Value	annotation	minLength	1		maxLength	3		pattern	[1-9]([1-9][0-9])?([12][0-9][0-9])?(3[0-5][0-9])?(36[0-5])?	
Kind	Value	annotation											
minLength	1												
maxLength	3												
pattern	[1-9]([1-9][0-9])?([12][0-9][0-9])?(3[0-5][0-9])?(36[0-5])?												
source	<pre><xs:element name="GiorniLavoroDipendente" type="cm:DatoGA_Type" minOccurs="0"/></pre>												

element [Periodo_Di_Lavoro_Type/GiorniPensione](#)

diagram													
namespace	urn:www.agenziaentrate.gov.it:specificheTecniche:sco:730:v1												
type	DatoGA_Type												
properties	<table> <tr><td>isRef</td><td>0</td></tr> <tr><td>minOcc</td><td>0</td></tr> <tr><td>maxOcc</td><td>1</td></tr> <tr><td>content</td><td>simple</td></tr> </table>	isRef	0	minOcc	0	maxOcc	1	content	simple				
isRef	0												
minOcc	0												
maxOcc	1												
content	simple												
facets	<table> <tr><td>Kind</td><td>Value</td><td>annotation</td></tr> <tr><td>minLength</td><td>1</td><td></td></tr> <tr><td>maxLength</td><td>3</td><td></td></tr> <tr><td>pattern</td><td>[1-9]([1-9][0-9])?([12][0-9][0-9])?(3[0-5][0-9])?(36[0-5])?</td><td></td></tr> </table>	Kind	Value	annotation	minLength	1		maxLength	3		pattern	[1-9]([1-9][0-9])?([12][0-9][0-9])?(3[0-5][0-9])?(36[0-5])?	
Kind	Value	annotation											
minLength	1												
maxLength	3												
pattern	[1-9]([1-9][0-9])?([12][0-9][0-9])?(3[0-5][0-9])?(36[0-5])?												
source	<pre><xs:element name="GiorniPensione" type="cm:DatoGA_Type" minOccurs="0"/></pre>												

complexType **Primo_Modulo_Acconti_Ritenute_Type**

<p>diagram</p>	
<p>namespace</p>	<p>urn:www.agenziaentrate.gov.it:specificheTecniche:sco:730:v1</p>
<p>children</p>	<p>m730:Accontilrpef m730:AltreRitenute m730:Eccedenze m730:RitenuteAccontiSospesi m730:MisuraAcconti m730:EsenzioneAddComunale m730:Dati730Integrativo m730:AccontiAltriDati</p>
<p>used by</p>	<p>element Acconti_Ritenute_Type/PrimoModulo</p>
<p>source</p>	<pre><xs:complexType name="Primo_Modulo_Acconti_Ritenute_Type"> <xs:sequence> <xs:element name="Accontilrpef" type="m730:Acconti_Irpef_Anno_Iposta_Type" minOccurs="0"/> <xs:element name="AltreRitenute" type="m730:Altre_Ritenute_Type" minOccurs="0"/> <xs:element name="Eccedenze" type="m730:Eccedenze_Type" minOccurs="0"/> <xs:element name="RitenuteAccontiSospesi" type="m730:Ritenute_Acconti_Sospesi_Type" minOccurs="0"/> <xs:element name="MisuraAcconti" type="m730:Misura_Acconti_Type" minOccurs="0"/> <xs:element name="EsenzioneAddComunale" type="m730:Esenzione_Add_Comunale_Type" minOccurs="0"/> <xs:element name="Dati730Integrativo" type="m730:Dati_730Integrativo_Type" minOccurs="0"/> <xs:element name="AccontiAltriDati" type="m730:Acconti_Altri_Dati_Type" minOccurs="0"/> </xs:sequence> </xs:complexType></pre>

element **Primo_Modulo_Acconti_Ritenute_Type/Accontilrpef**

diagram	
namespace	urn:www.agenziaentrate.gov.it:specificheTecniche:sco:730:v1
type	m730:Acconti_Irpef_Anno_Imposta_Type
properties	isRef 0 minOcc 0 maxOcc 1 content complex
children	m730:PrimaRataAccontolrpef m730:SecondaRataAccontolrpef m730:EccedenzaAccontolrpef m730:AccontoAddComunale m730:AccontoAddComunaleF24 m730:PrimaRataAccontoCedolare m730:SecondaRataAccontoCedolare m730:EccedenzaAccontoCedolare
source	<pre><xs:element name="AccontiIrpef" type="m730:Acconti_Irpef_Anno_Imposta_Type" minOccurs="0"/></pre>

element **Primo_Modulo_Acconti_Ritenute_Type/AltreRitenute**

diagram	
namespace	urn:www.agenziaentrate.gov.it:specificheTecniche:sco:730:v1

type	m730:Altre Ritenute Type
properties	isRef 0 minOcc 0 maxOcc 1 content complex
children	m730:AltreRitenuteIrpef m730:AddizionaleRegionale m730:AddizionaleComunale m730:AddRegionaleIrpefAttivitaSport m730:IrpefLavoriSocialmenteUtili m730:AddRegionaleIrpefLavoriSoc Utili
source	<code><xs:element name="AltreRitenute" type="m730:Altre_Ritenute_Type" minOccurs="0"/></code>

element **Primo_Modulo_Acconti_Ritenute_Type/Eccedenze**

diagram	
namespace	urn:www.agenziaentrate.gov.it:specificheTecniche:sco:730:v1
type	m730:Eccedenze Type
properties	isRef 0 minOcc 0 maxOcc 1 content complex
children	m730:Irpef m730:IrpefCompF24 m730:SostitutivaQuadroRT m730:SostitutivaQuadroRTcompF24 m730:CodiceRegione m730:AddRegionaleIrpef m730:AddRegionaleIrpefCompF24 m730:CodiceCatastaleComune m730:AddComunaleIrpef m730:AddComunaleIrpefF24
source	<code><xs:element name="Eccedenze" type="m730:Eccedenze_Type" minOccurs="0"/></code>

element **Primo_Modulo_Acconti_Ritenute_Type/RitenuteAccontiSospesi**

diagram	
namespace	urn:www.agenziaentrate.gov.it:specificheTecniche:sco:730:v1
type	m730:Ritenute_Acconti_Sospesi_Type
properties	isRef 0 minOcc 0 maxOcc 1 content complex
children	m730:CodiceEvento m730:Irpef m730:AddRegionaleIrpef m730:AddComunaleIrpef m730:SostitutivaProduttivita m730:CedolareSecca m730:ContribSolidarieta
source	<pre><xs:element name="RitenuteAccontiSospesi" type="m730:Ritenute_Acconti_Sospesi_Type" minOccurs="0"/></pre>

element **Primo_Modulo_Acconti_Ritenute_Type/MisuraAcconti**

diagram	
namespace	urn:www.agenziaentrate.gov.it:specificheTecniche:sco:730:v1
type	m730:Misura_Acconti_Type
properties	isRef 0 minOcc 0 maxOcc 1 content complex
children	m730:IrpefMisuralInferiore m730:AddComunaleMisuralInferiore m730:CedolareSeccaMisuralInferiore m730:NumeroRate

source	<code><xs:element name="MisuraAcconti" type="m730:Misura_Acconti_Type" minOccurs="0"/></code>
--------	---

element **Primo_Modulo_Acconti_Ritenute_Type/EsenzioneAddComunale**

diagram	
namespace	urn:www.agenziaentrate.gov.it:specificheTecniche:sco:730:v1
type	m730:Esenzione_Add_Comunale_Type
properties	isRef 0 minOcc 0 maxOcc 1 content complex
children	m730:SogliaEsenzioneSaldo m730:SogliaEsenzioneAcconto
source	<code><xs:element name="EsenzioneAddComunale" type="m730:Esenzione_Add_Comunale_Type" minOccurs="0"/></code>

element **Primo_Modulo_Acconti_Ritenute_Type/Dati730Integrativo**

diagram	
namespace	urn:www.agenziaentrate.gov.it:specificheTecniche:sco:730:v1
type	m730:Dati_730Integrativo_Type
properties	isRef 0 minOcc 0 maxOcc 1 content complex
children	m730:Rimborso m730:Credito
source	<code><xs:element name="Dati730Integrativo" type="m730:Dati_730Integrativo_Type" minOccurs="0"/></code>

element **Primo_Modulo_Acconti_Ritenute_Type/AccontiAltriDati**

diagram	
namespace	urn:www.agenziaentrate.gov.it:specificheTecniche:sco:730:v1
type	m730:Acconti_Altri_Dati_Type
properties	isRef 0 minOcc 0 maxOcc 1 content complex
children	m730:IncapientiDetrazioneFigli m730:IncapientiDetrazioneLocazione m730:RestituzioneBonusFiscale m730:RestituzioneBonusStraordinario m730:Pignoramento
source	<pre><xs:element name="AccontiAltriDati" type="m730:Acconti_Altri_Dati_Type" minOccurs="0"/></pre>

complexType **Primo_Modulo_Crediti_Imposta_Type**

diagram	
namespace	urn:www.agenziaentrate.gov.it:specificheTecniche:sco:730:v1
children	m730:CreditoImpostaFabbicati m730:CreditoImpostaFondiPensione m730:CreditoImpostaRedditiEsteri m730:CreditoPrimaCasaSismaAbruzzo m730:CreditoAltriSismaAbruzzo m730:CreditoIncrementoOccupazione m730:CreditoImpostaMediazioni
used by	element Crediti_Imposta/Primo_Modulo
source	<pre><xs:complexType name="Primo_Modulo_Crediti_Imposta_Type"> <xs:sequence></pre>

```

<xs:element name="CreditiImpostaFabbicati"
type="m730:Crediti_Imposta_Fabbicati_Type" minOccurs="0"/>
  <xs:element name="CreditiImpostaFondiPensione"
minOccurs="0">
  <xs:complexType>
    <xs:complexContent>
      <xs:extension
base="m730:Crediti_Imposta_Fondi_Pensione_Type">
        <xs:sequence>
          <xs:element
name="ResiduoPrecedenteDichiarazione" type="cm:DatoNP_Type"
minOccurs="0"/>
            <xs:element name="DiCuiCompensatoF24"
type="cm:DatoNP_Type" minOccurs="0"/>
          </xs:sequence>
        </xs:extension>
      </xs:complexContent>
    </xs:complexType>
  </xs:element>
  <xs:element name="CreditiImpostaRedditiEsteri"
type="m730:Crediti_Imposta_Redditi_Esteri_Type"
minOccurs="0"/>
  <xs:element name="CreditoPrimaCasaSismaAbruzzo"
minOccurs="0">
  <xs:complexType>
    <xs:complexContent>
      <xs:extension
base="m730:Credito_Immobile_Sisma_Abruzzo_Type">
        <xs:sequence>
          <xs:element
name="ResiduoPrecedenteDichiarazione" type="cm:DatoNP_Type"
minOccurs="0"/>
            </xs:sequence>
          </xs:extension>
        </xs:complexContent>
      </xs:complexType>
    </xs:element>
  <xs:element name="CreditoAltriSismaAbruzzo"
type="m730:Crediti_Imposta_Altri_Sisma_Abruzzo_Type"
minOccurs="0"/>
  <xs:element name="CreditoIncrementoOccupazione"
minOccurs="0">
  <xs:complexType>
    <xs:sequence>
      <xs:element name="ResiduoPrecedenteDichiarazione"
type="cm:DatoNP_Type" minOccurs="0"/>
      <xs:element name="DiCuiCompensatoF24"

```

```

type="cm:DatoNP_Type" minOccurs="0"/>
    </xs:sequence>
  </xs:complexType>
</xs:element>
<xs:element name="CreditoImpostaMediazioni"
type="m730:Residuo_Credito_Compens_AnnoImposta_Type"
minOccurs="0"/>
  </xs:sequence>
</xs:complexType>

```

element **Primo_Modulo_Crediti_Imposta_Type/CreditiImpostaFabbicati**

diagram	
namespace	urn:www.agenziaentrate.gov.it:specificheTecniche:sco:730:v1
type	m730:Crediti_Imposta_Fabbicati_Type
properties	isRef 0 minOcc 0 maxOcc 1 content complex
children	m730:ResiduoFabbicati m730:CanoniLocazioneNonPercepiti
source	<xs:element name="CreditiImpostaFabbicati" type="m730:Crediti_Imposta_Fabbicati_Type" minOccurs="0"/>

element **Primo_Modulo_Crediti_Imposta_Type/CreditiImpostaFondiPensione**

diagram	
namespace	urn:www.agenziaentrate.gov.it:specificheTecniche:sco:730:v1

type	extension of m730:Crediti Imposta Fondi Pensione Type
properties	isRef 0 minOcc 0 maxOcc 1 content complex
children	m730:AnnoAnticipazione m730:Reintegro m730:SommaReintegrata m730:CreditoAnno m730:ResiduoPrecedenteDichiarazione m730:DiCuiCompensatoF24
source	<pre> <xs:element name="CreditiImpostaFondiPensione" minOccurs="0"> <xs:complexType> <xs:complexContent> <xs:extension base="m730:Crediti_Imposta_Fondi_Pensione_Type"> <xs:sequence> <xs:element name="ResiduoPrecedenteDichiarazione" type="cm:DatoNP_Type" minOccurs="0"/> <xs:element name="DiCuiCompensatoF24" type="cm:DatoNP_Type" minOccurs="0"/> </xs:sequence> </xs:extension> </xs:complexContent> </xs:complexType> </xs:element> </pre>

element

Primo_Modulo_Crediti_Imposta_Type/CreditiImpostaFondiPensione/ResiduoPrecedenteDichiarazione

diagram	
namespace	urn:www.agenziaentrate.gov.it:specificheTecniche:sco:730:v1
type	DatoNP_Type
properties	isRef 0 minOcc 0 maxOcc 1 content simple
facets	Kind Value annotation pattern [1-9]{1}[0-9]*
source	<pre> <xs:element name="ResiduoPrecedenteDichiarazione" type="cm:DatoNP_Type" minOccurs="0"/> </pre>

element Primo_Modulo_Crediti_Imposta_Type/CreditiImpostaFondiPensione/DiCuiCompensatoF24

diagram	
namespace	urn:www.agenziaentrate.gov.it:specificheTecniche:sco:730:v1
type	DatoNP_Type
properties	isRef 0 minOcc 0 maxOcc 1

	content simple
facets	Kind Value annotation pattern [1-9]{1}[0-9]*
source	<code><xs:element name="DiCuiCompensatoF24" type="cm:DatoNP_Type" minOccurs="0"/></code>

element **Primo_Modulo_Crediti_Imposta_Type/CreditiImpostaRedditiEsteri**

diagram	<p>The diagram illustrates the structure of the <code>m730:Crediti_Imposta_Redditi_Esteri_Type</code> element. It is a container element (represented by a dashed box) that contains a sequence of child elements (represented by solid boxes). The child elements are: <code>m730:StatoEsteri</code>, <code>m730:Anno</code>, <code>m730:RedditoEsteri</code>, <code>m730:ImpostaEsteri</code>, <code>m730:RedditoComplessivo</code>, <code>m730:Imposta_Lorda</code>, <code>m730:Impostalletta</code>, <code>m730:CreditoDichiarazioniPrecedenti</code>, and <code>m730:DiCuiStatoEsteri</code>. The container element is connected to the sequence of child elements via a sequence connector (represented by a circle with three dots).</p>
namespace	urn:www.agenziaentrate.gov.it:specificheTecniche:sco:730:v1
type	m730:Crediti_Imposta_Redditi_Esteri_Type
properties	isRef 0 minOcc 0 maxOcc 1 content complex
children	m730:StatoEsteri m730:Anno m730:RedditoEsteri m730:ImpostaEsteri m730:RedditoComplessivo m730:Imposta_Lorda m730:ImpostaNetta m730:CreditoDichiarazioniPrecedenti m730:DiCuiStatoEsteri
source	<code><xs:element name="CreditiImpostaRedditiEsteri" type="m730:Crediti_Imposta_Redditi_Esteri_Type" minOccurs="0"/></code>

element **Primo_Modulo_Crediti_Imposta_Type/CreditoPrimaCasaSismaAbruzzo**

diagram									
namespace	urn:www.agenziaentrate.gov.it:specificheTecniche:sco:730:v1								
type	extension of m730:Credito_Immobile_Sisma_Abruzzo_Type								
properties	<table border="0"> <tr><td>isRef</td><td>0</td></tr> <tr><td>minOcc</td><td>0</td></tr> <tr><td>maxOcc</td><td>1</td></tr> <tr><td>content</td><td>complex</td></tr> </table>	isRef	0	minOcc	0	maxOcc	1	content	complex
isRef	0								
minOcc	0								
maxOcc	1								
content	complex								
children	m730:CodiceFiscale m730:NumeroRata m730:TotaleCredito m730:ResiduoPrecedenteDichiarazione								
source	<pre> <xs:element name="CreditoPrimaCasaSismaAbruzzo" minOccurs="0"> <xs:complexType> <xs:complexContent> <xs:extension base="m730:Credito_Immobile_Sisma_Abruzzo_Type"> <xs:sequence> <xs:element name="ResiduoPrecedenteDichiarazione" type="cm:DatoNP_Type" minOccurs="0"/> </xs:sequence> </xs:extension> </xs:complexContent> </xs:complexType> </xs:element> </pre>								

element **Primo_Modulo_Crediti_Imposta_Type/CreditoPrimaCasaSismaAbruzzo/ResiduoPrecedenteDichiarazione**

diagram									
namespace	urn:www.agenziaentrate.gov.it:specificheTecniche:sco:730:v1								
type	DatoNP_Type								
properties	<table border="0"> <tr><td>isRef</td><td>0</td></tr> <tr><td>minOcc</td><td>0</td></tr> <tr><td>maxOcc</td><td>1</td></tr> <tr><td>content</td><td>simple</td></tr> </table>	isRef	0	minOcc	0	maxOcc	1	content	simple
isRef	0								
minOcc	0								
maxOcc	1								
content	simple								
facets	<table border="0"> <tr><td>Kind</td><td>Value</td><td>annotation</td></tr> <tr><td>pattern</td><td>[1-9]{1}[0-9]*</td><td></td></tr> </table>	Kind	Value	annotation	pattern	[1-9]{1}[0-9]*			
Kind	Value	annotation							
pattern	[1-9]{1}[0-9]*								

source	<pre><xs:element name="ResiduoPrecedenteDichiarazione" type="cm:DatoNP_Type" minOccurs="0"/></pre>
--------	--

element Primo_Modulo_Crediti_Imposta_Type/CreditoAltriSismaAbruzzo

diagram	<p>The diagram shows a class <code>m730:CreditoAltriSismaAbruzzo</code> (represented by a dashed box) containing three sub-elements: <code>m730:Impresa Professione</code>, <code>m730:CreditoImmobileSismaA...</code>, and <code>m730:Rateazione</code>. These sub-elements are grouped within a larger dashed box labeled <code>m730:Crediti_Imposta_Altri_Sisma_Abruzzo_Type</code>.</p>
namespace	urn:www.agenziaentrate.gov.it:specificheTecniche:sco:730:v1
type	m730:Crediti Imposta Altri Sisma Abruzzo Type
properties	isRef 0 minOcc 0 maxOcc 1 content complex
children	m730:Impresa Professione m730:CreditoImmobileSismaAbruzzo m730:Rateazione
source	<pre><xs:element name="CreditoAltriSismaAbruzzo" type="m730:Crediti_Imposta_Altri_Sisma_Abruzzo_Type" minOccurs="0"/></pre>

element Primo_Modulo_Crediti_Imposta_Type/CreditoIncrementoOccupazione

diagram	<p>The diagram shows a class <code>m730:CreditoIncrementoOccupazione</code> (represented by a dashed box) containing two sub-elements: <code>m730:ResiduoPrecedenteDichia...</code> and <code>m730:DiCuiCompensatoF24</code>.</p>
namespace	urn:www.agenziaentrate.gov.it:specificheTecniche:sco:730:v1
properties	isRef 0 minOcc 0 maxOcc 1 content complex
children	m730:ResiduoPrecedenteDichiarazione m730:DiCuiCompensatoF24
source	<pre><xs:element name="CreditoIncrementoOccupazione" minOccurs="0"> <xs:complexType> <xs:sequence> <xs:element name="ResiduoPrecedenteDichiarazione" type="cm:DatoNP_Type" minOccurs="0"/> <xs:element name="DiCuiCompensatoF24" type="cm:DatoNP_Type" minOccurs="0"/> </xs:sequence> </xs:complexType></pre>

	<code></xs:element></code>
--	----------------------------------

element

Primo_Modulo_Crediti_Imposta_Type/CreditoIncrementoOccupazione/ResiduoPrecedenteDichiarazione

diagram	
namespace	urn:www.agenziaentrate.gov.it:specificheTecniche:sco:730:v1
type	DatoNP_Type
properties	isRef 0 minOcc 0 maxOcc 1 content simple
facets	Kind Value annotation pattern [1-9]{1}[0-9]*
source	<code><xs:element name="ResiduoPrecedenteDichiarazione" type="cm:DatoNP_Type" minOccurs="0"/></code>

element **Primo_Modulo_Crediti_Imposta_Type/CreditoIncrementoOccupazione/DiCuiCompensatoF24**

diagram	
namespace	urn:www.agenziaentrate.gov.it:specificheTecniche:sco:730:v1
type	DatoNP_Type
properties	isRef 0 minOcc 0 maxOcc 1 content simple
facets	Kind Value annotation pattern [1-9]{1}[0-9]*
source	<code><xs:element name="DiCuiCompensatoF24" type="cm:DatoNP_Type" minOccurs="0"/></code>

element **Primo_Modulo_Crediti_Imposta_Type/CreditoImpostaMediazioni**

diagram	
namespace	urn:www.agenziaentrate.gov.it:specificheTecniche:sco:730:v1
type	m730:Residuo_Credito_Compens_AnnolImposta_Type

properties	isRef 0 minOcc 0 maxOcc 1 content complex
children	m730:ResiduoPrecedenteDichiarazione m730:CreditoAnno m730:DiCuiCompensatoF24
source	<pre><xs:element name="CreditoImpostaMediazioni" type="m730:Residuo_Credito_Compens_AnnoImposta_Type" minOccurs="0"/></pre>

complexType **Primo_Modulo_Lavoro_Dip_Type**

diagram	
namespace	urn:www.agenziaentrate.gov.it:specificheTecniche:sco:730:v1
children	m730:LavoroDipendente m730:PeriodoLavoro m730:IncrementoProduttivita m730:AltriRedditiAssLavDip m730:RitenuteLavoroDipendente m730:SicurezzaDetrazione m730:ContribSolidarietaRiduzione m730:ContribSolidarietaTrattenuto
used by	element Redditi_Lavoro_Dip_Type/Primo_Modulo
source	<pre><xs:complexType name="Primo_Modulo_Lavoro_Dip_Type"> <xs:sequence> <xs:element name="LavoroDipendente" type="m730:Lavoro_Dipendente_Type" maxOccurs="3"/> <xs:element name="PeriodoLavoro" type="m730:Periodo_Di_Lavoro_Type" minOccurs="0"/> <xs:element name="IncrementoProduttivita" type="m730:Incremento_Produttivita_Type" minOccurs="0"/> <xs:element name="AltriRedditiAssLavDip" type="m730:Altri_Redditi_Ass_Lavd_Type" minOccurs="0" maxOccurs="3"/> <xs:element name="RitenuteLavoroDipendente" type="m730:Ritenute_Lavoro_Dip_Type" minOccurs="0"/> <xs:element name="SicurezzaDetrazione"</pre>

	<pre> type="cm:DatoNP_Type" minOccurs="0"/> <xs:element name="ContribSolidarietaRiduzione" type="cm:DatoNP_Type" minOccurs="0"/> <xs:element name="ContribSolidarietaTrattenuto" type="cm:DatoNP_Type" minOccurs="0"/> </xs:sequence> </xs:complexType> </pre>
--	---

element **Primo Modulo Lavoro Dip Type/LavoroDipendente**

diagram	
namespace	urn:www.agenziaentrate.gov.it:specificheTecniche:sco:730:v1
type	m730:Lavoro_Dipendente_Type
properties	isRef 0 minOcc 1 maxOcc 3 content complex
children	m730:TipologiaReddito m730:TipoContratto m730:Reddito
source	<pre> <xs:element name="LavoroDipendente" type="m730:Lavoro_Dipendente_Type" maxOccurs="3"/> </pre>

element **Primo Modulo Lavoro Dip Type/PeriodoLavoro**

diagram	
namespace	urn:www.agenziaentrate.gov.it:specificheTecniche:sco:730:v1
type	m730:Periodo_Di_Lavoro_Type
properties	isRef 0 minOcc 0 maxOcc 1 content complex
children	m730:GiorniLavoroDipendente m730:GiorniPensione
source	<pre> <xs:element name="PeriodoLavoro" type="m730:Periodo_Di_Lavoro_Type" minOccurs="0"/> </pre>

element **Primo_Modulo_Lavoro_Dip_Type/IncrementoProduttivita**

diagram	
namespace	urn:www.agenziaentrate.gov.it:specificheTecniche:sco:730:v1
type	m730:Incremento_Produttivita_Type
properties	isRef 0 minOcc 0 maxOcc 1 content complex
children	m730:ImportoTassazOrdinaria m730:ImportoImpostaSostitutiva m730:RitenuteImpostaSostitutiva m730:Art51Ordinaria m730:Art51Sostitutiva m730:TassazOrdinaria m730:TassazSostitutiva
source	<pre><xs:element name="IncrementoProduttivita" type="m730:Incremento_Produttivita_Type" minOccurs="0"/></pre>

element **Primo_Modulo_Lavoro_Dip_Type/AltriRedditiAssLavDip**

diagram	
namespace	urn:www.agenziaentrate.gov.it:specificheTecniche:sco:730:v1
type	m730:Altri_Redditi_Ass_Lavd_Type
properties	isRef 0 minOcc 0 maxOcc 3 content complex
children	m730:AssegnoDelConiuge m730:ImportoRedditoAssimilato
source	<pre><xs:element name="AltriRedditiAssLavDip" type="m730:Altri_Redditi_Ass_Lavd_Type" minOccurs="0"/></pre>

```
maxOccurs="3"/>
```

element **Primo_Modulo_Lavoro_Dip_Type/RitenuteLavoroDipendente**

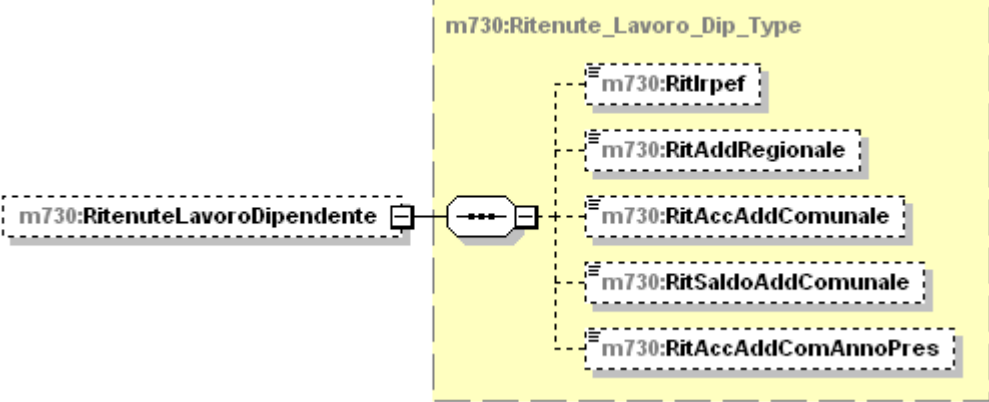
diagram	
namespace	urn:www.agenziaentrate.gov.it:specificheTecniche:sco:730:v1
type	m730:Ritenute_Lavoro_Dip_Type
properties	isRef 0 minOcc 0 maxOcc 1 content complex
children	m730:Ritlrpef m730:RitAddRegionale m730:RitAccAddComunale m730:RitSaldoAddComunale m730:RitAccAddComAnnoPres
source	<pre><xs:element name="RitenuteLavoroDipendente" type="m730:Ritenute_Lavoro_Dip_Type" minOccurs="0"/></pre>

element **Primo_Modulo_Lavoro_Dip_Type/SicurezzaDetrazione**

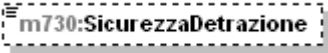
diagram	
namespace	urn:www.agenziaentrate.gov.it:specificheTecniche:sco:730:v1
type	DatoNP_Type
properties	isRef 0 minOcc 0 maxOcc 1 content simple
facets	Kind Value annotation pattern [1-9]{1}[0-9]*
source	<pre><xs:element name="SicurezzaDetrazione" type="cm:DatoNP_Type" minOccurs="0"/></pre>

element **Primo_Modulo_Lavoro_Dip_Type/ContribSolidarietaRiduzione**

diagram	
---------	---

namespace	urn:www.agenziaentrate.gov.it:specificheTecniche:sco:730:v1
type	DatoNP_Type
properties	isRef 0 minOcc 0 maxOcc 1 content simple
facets	Kind Value annotation pattern [1-9]{1}[0-9]*
source	<code><xs:element name="ContribSolidarietaRiduzione" type="cm:DatoNP_Type" minOccurs="0"/></code>

element Primo_Modulo_Lavoro_Dip_Type/ContribSolidarietaTrattenuto

diagram	
namespace	urn:www.agenziaentrate.gov.it:specificheTecniche:sco:730:v1
type	DatoNP_Type
properties	isRef 0 minOcc 0 maxOcc 1 content simple
facets	Kind Value annotation pattern [1-9]{1}[0-9]*
source	<code><xs:element name="ContribSolidarietaTrattenuto" type="cm:DatoNP_Type" minOccurs="0"/></code>

complexType **Primo_Modulo_PL_Type**

<p>diagram</p>	
<p>namespace</p>	<p>urn:www.agenziaentrate.gov.it:specificheTecniche:sco:730:v1</p>
<p>children</p>	<p>m730:RiepilogoRedditi m730:ImpostaLorda m730:DetrazioniCrediti m730:ImpostaNetta m730:Addizionali m730:CedolareSecca m730:ContributoSolidarietà m730:LiquidazioneImposte m730:AltriDati m730:DatiF24IMU m730:CredImpEsteri</p>
<p>used by</p>	<p>element Prospetto Liquidazione Type/PrimoModulo</p>
<p>source</p>	<pre> <xs:complexType name="Primo_Modulo_PL_Type"> <xs:sequence> <xs:element name="RiepilogoRedditi" type="m730:Riepilogo_Redditi_Type" minOccurs="0"/> <xs:element name="ImpostaLorda" type="m730:Imposta_Lorda_Type" minOccurs="0"/> <xs:element name="DetrazioniCrediti" type="m730:Detrazione_Crediti_Type" minOccurs="0"/> <xs:element name="ImpostaNetta" type="m730:Imposta_Netta_Type" minOccurs="0"/> <xs:element name="Addizionali" type="m730:Addizionali_Type" minOccurs="0"/> <xs:element name="CedolareSecca" type="m730:Cedolare_Secca_Type" minOccurs="0"/> <xs:element name="ContributoSolidarietà" type="m730:Contributo_Solidarietà_Type" minOccurs="0"/> <xs:element name="LiquidazioneImposte" minOccurs="0"> <xs:complexType> <xs:sequence> <xs:element name="EsitoIrpef" </pre>

```
type="m730:Esito_Liquidazione_Type" minOccurs="0"/>
  <xs:element name="EsitoAddRegionale"
type="m730:Esito_Liquidazione_Type" minOccurs="0"/>
  <xs:element name="EsitoAddComunale"
type="m730:Esito_Liquidazione_Type" minOccurs="0"/>
  <xs:element name="PrimaRataAccIrpef"
type="cm:DatoNP_Type" minOccurs="0"/>
  <xs:element name="SecondaRataAccIrpef"
type="cm:DatoNP_Type" minOccurs="0"/>
  <xs:element name="AccontoTassSep"
type="m730:Debito_Type" minOccurs="0"/>
  <xs:element name="AccontoAddCom2012"
type="cm:DatoNP_Type" minOccurs="0"/>
  <xs:element name="ImpSostProduit"
type="m730:Debito_Type" minOccurs="0"/>
  <xs:element name="EsitoCedolareSecca"
type="m730:Esito_Liquidazione_Type" minOccurs="0"/>
  <xs:element name="PrimaRataAccCedolare"
type="cm:DatoNP_Type" minOccurs="0"/>
  <xs:element name="SecondaRataAccCedolare"
type="cm:DatoNP_Type" minOccurs="0"/>
  <xs:element name="ContribSolidarietàDebito"
type="m730:Debito_Type" minOccurs="0"/>
  </xs:sequence>
</xs:complexType>
</xs:element>
  <xs:element name="AltriDati" type="m730:Altri_Dati_Type"
minOccurs="0"/>
  <xs:element name="DatiF24IMU"
type="m730:Dati_F24_Imu_Type" minOccurs="0"/>
  <xs:element name="CredImpEestero"
type="m730:Cred_Imp_Estero_Type" minOccurs="0"/>
  </xs:sequence>
</xs:complexType>
```

element **Primo_Modulo_PL_Type/RiepilogoRedditi**

diagram	<p>The diagram illustrates the structure of the <code>m730:RiepilogoRedditi_Type</code>. It is a complex type containing several sub-elements: <code>m730:Dominicali</code>, <code>m730:Agrari</code>, <code>m730:Fabbricati</code>, <code>m730:LavDip</code>, <code>m730:AltriRedditi</code>, <code>m730:ImponibileCedolare</code>, <code>m730:ImponibileCedolareOrdina...</code>, and <code>m730:ImponibileCedolareAgevo...</code>.</p>								
namespace	urn:www.agenziaentrate.gov.it:specificheTecniche:sco:730:v1								
type	m730:Riepilogo Redditi Type								
properties	<table> <tr><td>isRef</td><td>0</td></tr> <tr><td>minOcc</td><td>0</td></tr> <tr><td>maxOcc</td><td>1</td></tr> <tr><td>content</td><td>complex</td></tr> </table>	isRef	0	minOcc	0	maxOcc	1	content	complex
isRef	0								
minOcc	0								
maxOcc	1								
content	complex								
children	m730:Dominicali m730:Agrari m730:Fabbricati m730:LavDip m730:AltriRedditi m730:ImponibileCedolare m730:ImponibileCedolareOrdinario m730:ImponibileCedolareAgevolato								
source	<pre><xs:element name="RiepilogoRedditi" type="m730:Riepilogo_Redditi_Type" minOccurs="0"/></pre>								

element **Primo_Modulo_PL_Type/ImpostaLorda**

diagram	<p>The diagram illustrates the structure of the <code>m730:Imposta_Lorda_Type</code>. It is a complex type containing several sub-elements: <code>m730:RedditoComplessivo</code>, <code>m730:DeduzAbPrinc</code>, <code>m730:OneriDeducibili</code>, <code>m730:RedditoImponibile</code>, <code>m730:CompensiAttSport</code>, and <code>m730:ImportoImpostaLorda</code>.</p>
namespace	urn:www.agenziaentrate.gov.it:specificheTecniche:sco:730:v1

type	m730:Imposta_Lorda_Type
properties	isRef 0 minOcc 0 maxOcc 1 content complex
children	m730:RedditoComplessivo m730:DeduzAbPrinc m730:OneriDeducibili m730:RedditoImponibile m730:CompensiAttSport m730:ImportoImpostaLorda
source	<pre><xs:element name="ImpostaLorda" type="m730:Imposta_Lorda_Type" minOccurs="0"/></pre>

element **Primo_Modulo_PL_Type/DetrazioniCrediti**

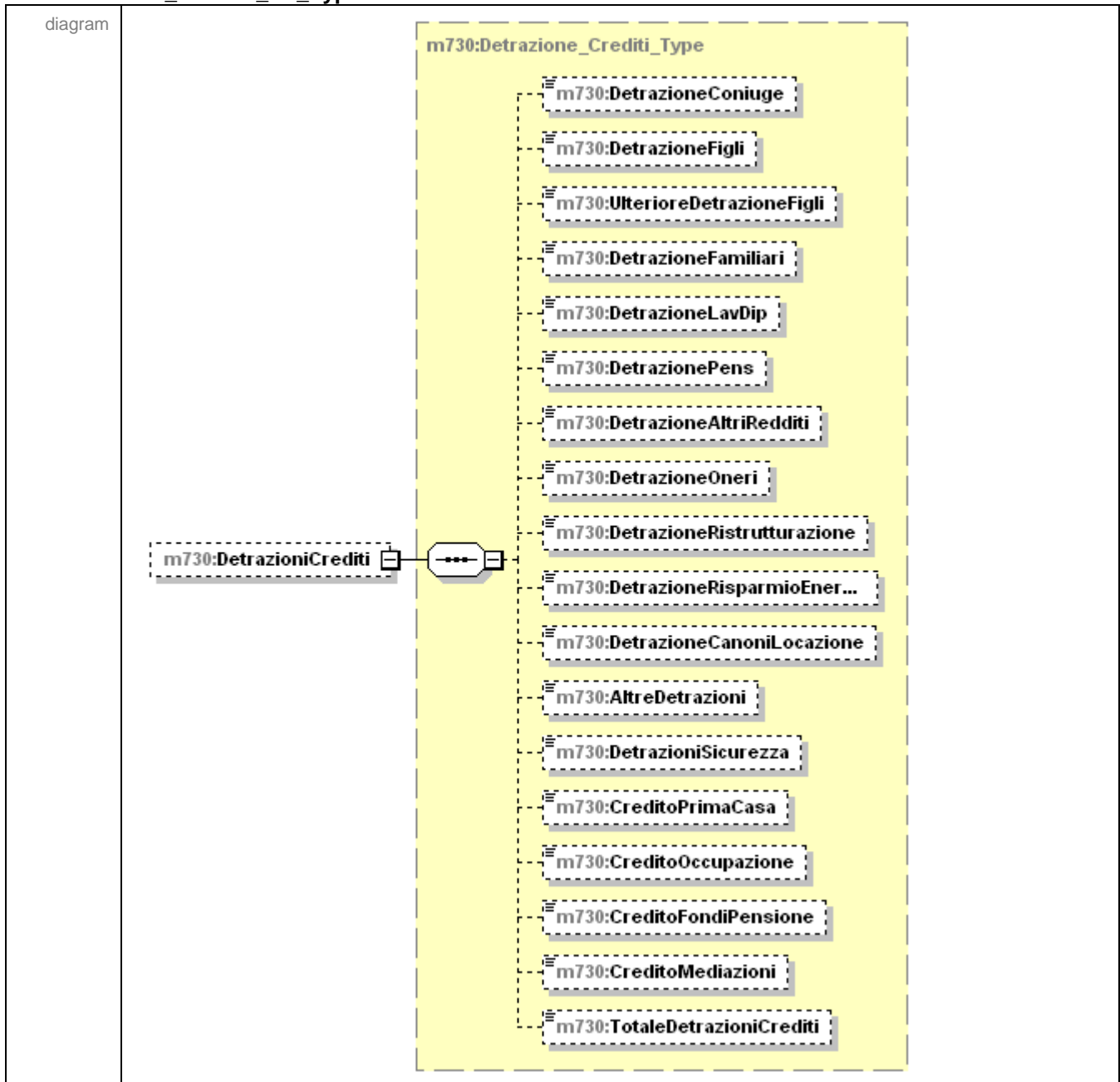

namespace	urn:www.agenziaentrate.gov.it:specificheTecniche:sco:730:v1
type	m730:Detrazione_Crediti_Type
properties	isRef 0 minOcc 0 maxOcc 1 content complex
children	m730:DetrazioneConiuge m730:DetrazioneFigli m730:UlterioreDetrazioneFigli m730:DetrazioneFamiliari m730:DetrazioneLavDip m730:DetrazionePens m730:DetrazioneAltriRedditi m730:DetrazioneOneri m730:DetrazioneRistrutturazione m730:DetrazioneRisparmioEnergetico m730:DetrazioneCanoniLocazione m730:AltreDetrazioni m730:DetrazioniSicurezza m730:CreditoPrimaCasa m730:CreditoOccupazione m730:CreditoFondiPensione m730:CreditoMediazioni m730:TotaleDetrazioniCrediti
source	<pre><xs:element name="DetrazioniCrediti" type="m730:Detrazione_Crediti_Type" minOccurs="0"/></pre>

element Primo_Modulo_PL_Type/ImpostaNetta

diagram	
namespace	urn:www.agenziaentrate.gov.it:specificheTecniche:sco:730:v1
type	m730:Imposta_Netta_Type
properties	isRef 0 minOcc 0 maxOcc 1 content complex
children	m730:ImportoImpostaNetta m730:CredAltriSisma m730:CredAbitazSisma m730:CredImpEstere m730:CredCanNonPerc m730:Ritenute m730:Differenza m730:EccedenzaIrpef m730:AccontiVersati m730:RestituzioneBonus
source	<pre><xs:element name="ImpostaNetta" type="m730:Imposta_Netta_Type" minOccurs="0"/></pre>

element **Primo_Modulo_PL_Type/Addizionali**

<p>diagram</p>	
<p>namespace</p>	<p>urn:www.agenziaentrate.gov.it:specificheTecniche:sco:730:v1</p>
<p>type</p>	<p>m730:Addizionali_Type</p>
<p>properties</p>	<p>isRef 0 minOcc 0 maxOcc 1 content complex</p>
<p>children</p>	<p>m730:Imponibile m730:AddRegDovuta m730:AddRegCertif m730:EccedenzaAddReg m730:AddComDovuta m730:AddComCertif m730:EccedenzaAddCom m730:AccontoAddCom2012 m730:AccontoAddCom2012Certif</p>
<p>source</p>	<pre><xs:element name="Addizionali" type="m730:Addizionali_Type" minOccurs="0"/></pre>

element **Primo_Modulo_PL_Type/CedolareSecca**

<p>diagram</p>	
<p>namespace</p>	<p>urn:www.agenziaentrate.gov.it:specificheTecniche:sco:730:v1</p>
<p>type</p>	<p>m730:Cedolare_Secca_Type</p>
<p>properties</p>	<p>isRef 0 minOcc 0 maxOcc 1 content complex</p>
<p>children</p>	<p>m730:CedolareDovuta m730:AccontoCedolare2011</p>

source	<code><xs:element name="CedolareSecca" type="m730:Cedolare_Secca_Type" minOccurs="0"/></code>
--------	---

element **Primo_Modulo_PL_Type/ContributoSolidarietà**

diagram	
namespace	urn:www.agenziaentrate.gov.it:specificheTecniche:sco:730:v1
type	m730:Contributo_Solidarietà_Type
properties	isRef 0 minOcc 0 maxOcc 1 content complex
children	m730:ImponibileContributo m730:ContributoDovuto m730:ContributoCertificaz
source	<code><xs:element name="ContributoSolidarietà" type="m730:Contributo_Solidarietà_Type" minOccurs="0"/></code>

element **Primo_Modulo_PL_Type/LiquidazioneImposte**

<p>diagram</p>	
<p>namespace</p>	<p>urn:www.agenziaentrate.gov.it:specificheTecniche:sco:730:v1</p>
<p>properties</p>	<p>isRef 0 minOcc 0 maxOcc 1 content complex</p>
<p>children</p>	<p>m730:EsitoIrpef m730:EsitoAddRegionale m730:EsitoAddComunale m730:PrimaRataAccIrpef m730:SecondaRataAccIrpef m730:AccontoTassSep m730:AccontoAddCom2012 m730:ImpSostProduct m730:EsitoCedolareSecca m730:PrimaRataAccCedolare m730:SecondaRataAccCedolare m730:ContribSolidarietàDebito</p>
<p>source</p>	<pre><xs:element name="LiquidazioneImposte" minOccurs="0"> <xs:complexType> <xs:sequence> <xs:element name="EsitoIrpef" type="m730:Esito_Liquidazione_Type" minOccurs="0"/> <xs:element name="EsitoAddRegionale" type="m730:Esito_Liquidazione_Type" minOccurs="0"/> <xs:element name="EsitoAddComunale" type="m730:Esito_Liquidazione_Type" minOccurs="0"/> <xs:element name="PrimaRataAccIrpef" type="cm:DatoNP_Type" minOccurs="0"/> <xs:element name="SecondaRataAccIrpef" type="cm:DatoNP_Type" minOccurs="0"/> <xs:element name="AccontoTassSep" type="m730:Debito_Type" minOccurs="0"/> <xs:element name="AccontoAddCom2012"</pre>

```

type="cm:DatoNP_Type" minOccurs="0"/>
  <xs:element name="ImpSostProdut"
type="m730:Debito_Type" minOccurs="0"/>
  <xs:element name="EsitoCedolareSecca"
type="m730:Esito_Liquidazione_Type" minOccurs="0"/>
  <xs:element name="PrimaRataAccCedolare"
type="cm:DatoNP_Type" minOccurs="0"/>
  <xs:element name="SecondaRataAccCedolare"
type="cm:DatoNP_Type" minOccurs="0"/>
  <xs:element name="ContribSolidarietàDebito"
type="m730:Debito_Type" minOccurs="0"/>
  </xs:sequence>
</xs:complexType>
</xs:element>

```

element Primo_Modulo_PL_Type/LiquidazioneImposte/EsitoIrpef

diagram	
namespace	urn:www.agenziaentrate.gov.it:specificheTecniche:sco:730:v1
type	m730:Esito_Liquidazione_Type
properties	isRef 0 minOcc 0 maxOcc 1 content complex
children	m730:Credito m730:Debito
source	<xs:element name="EsitoIrpef" type="m730:Esito_Liquidazione_Type" minOccurs="0"/>

element Primo_Modulo_PL_Type/LiquidazioneImposte/EsitoAddRegionale

diagram	
namespace	urn:www.agenziaentrate.gov.it:specificheTecniche:sco:730:v1
type	m730:Esito_Liquidazione_Type
properties	isRef 0 minOcc 0 maxOcc 1

	content complex
children	m730:Credito m730:Debito
source	<pre><xs:element name="EsitoAddRegionale" type="m730:Esito_Liquidazione_Type" minOccurs="0"/></pre>

element **Primo_Modulo_PL_Type/LiquidazioneImposte/EsitoAddComunale**

diagram	
namespace	urn:www.agenziaentrate.gov.it:specificheTecniche:sco:730:v1
type	m730:Esito_Liquidazione_Type
properties	isRef 0 minOcc 0 maxOcc 1 content complex
children	m730:Credito m730:Debito
source	<pre><xs:element name="EsitoAddComunale" type="m730:Esito_Liquidazione_Type" minOccurs="0"/></pre>

element **Primo_Modulo_PL_Type/LiquidazioneImposte/PrimaRataAcclrpef**

diagram	
namespace	urn:www.agenziaentrate.gov.it:specificheTecniche:sco:730:v1
type	DatoNP_Type
properties	isRef 0 minOcc 0 maxOcc 1 content simple
facets	Kind Value annotation pattern [1-9]{1}[0-9]*
source	<pre><xs:element name="PrimaRataAccIrpef" type="cm:DatoNP_Type" minOccurs="0"/></pre>

element **Primo_Modulo_PL_Type/LiquidazioneImposte/SecondaRataAcclrpef**

diagram	
namespace	urn:www.agenziaentrate.gov.it:specificheTecniche:sco:730:v1
type	DatoNP_Type
properties	isRef 0

	minOcc 0 maxOcc 1 content simple
facets	Kind Value annotation pattern [1-9]{1}[0-9]*
source	<pre><xs:element name="SecondaRataAccIrpef" type="cm:DatoNP_Type" minOccurs="0"/></pre>

element **Primo_Modulo_PL_Type/LiquidazioneImposte/AccontoTassSep**

diagram	<pre> classDiagram class m730Debito_Type { } class m730AccontoTassSep { } class m730NonVersare { } class m730ImportoDaTrattenere { } m730Debito_Type < -- m730AccontoTassSep m730Debito_Type < -- m730NonVersare m730Debito_Type < -- m730ImportoDaTrattenere </pre>
namespace	urn:www.agenziaentrate.gov.it:specificheTecniche:sco:730:v1
type	m730:Debito_Type
properties	isRef 0 minOcc 0 maxOcc 1 content complex
children	m730:NonVersare m730:ImportoDaTrattenere
source	<pre><xs:element name="AccontoTassSep" type="m730:Debito_Type" minOccurs="0"/></pre>

element **Primo_Modulo_PL_Type/LiquidazioneImposte/AccontoAddCom2012**

diagram	<pre> classDiagram class DatoNP_Type { } class m730AccontoAddCom2012 { } DatoNP_Type < -- m730AccontoAddCom2012 </pre>
namespace	urn:www.agenziaentrate.gov.it:specificheTecniche:sco:730:v1
type	DatoNP_Type
properties	isRef 0 minOcc 0 maxOcc 1 content simple
facets	Kind Value annotation pattern [1-9]{1}[0-9]*
source	<pre><xs:element name="AccontoAddCom2012" type="cm:DatoNP_Type" minOccurs="0"/></pre>

element **Primo_Modulo_PL_Type/LiquidazioneImposte/ImpSostProdut**

diagram	
namespace	urn:www.agenziaentrate.gov.it:specificheTecniche:sco:730:v1
type	m730:Debito_Type
properties	isRef 0 minOcc 0 maxOcc 1 content complex
children	m730:NonVersare m730:ImportoDaTrattenere
source	<pre><xs:element name="ImpSostProdut" type="m730:Debito_Type" minOccurs="0"/></pre>

element **Primo_Modulo_PL_Type/LiquidazioneImposte/EsitoCedolareSecca**

diagram	
namespace	urn:www.agenziaentrate.gov.it:specificheTecniche:sco:730:v1
type	m730:Esito_Liquidazione_Type
properties	isRef 0 minOcc 0 maxOcc 1 content complex
children	m730:Credito m730:Debito
source	<pre><xs:element name="EsitoCedolareSecca" type="m730:Esito_Liquidazione_Type" minOccurs="0"/></pre>

element **Primo_Modulo_PL_Type/LiquidazioneImposte/PrimaRataAccCedolare**

diagram	
namespace	urn:www.agenziaentrate.gov.it:specificheTecniche:sco:730:v1
type	DatoNP_Type
properties	isRef 0 minOcc 0 maxOcc 1 content simple
facets	Kind Value annotation

	pattern [1-9]{1}[0-9]*
source	<code><xs:element name="PrimaRataAccCedolare" type="cm:DatoNP_Type" minOccurs="0"/></code>

element **Primo_Modulo_PL_Type/LiquidazioneImposte/SecondaRataAccCedolare**

diagram	
namespace	urn:www.agenziaentrate.gov.it:specificheTecniche:sco:730:v1
type	DatoNP_Type
properties	isRef 0 minOcc 0 maxOcc 1 content simple
facets	Kind Value annotation pattern [1-9]{1}[0-9]*
source	<code><xs:element name="SecondaRataAccCedolare" type="cm:DatoNP_Type" minOccurs="0"/></code>

element **Primo_Modulo_PL_Type/LiquidazioneImposte/ContribSolidarietàDebito**

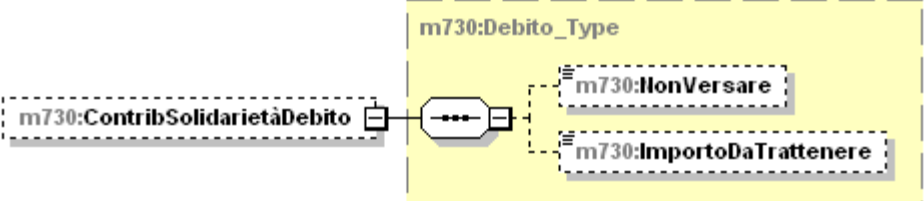
diagram	
namespace	urn:www.agenziaentrate.gov.it:specificheTecniche:sco:730:v1
type	m730:Debito_Type
properties	isRef 0 minOcc 0 maxOcc 1 content complex
children	m730:NonVersare m730:ImportoDaTrattenere
source	<code><xs:element name="ContribSolidarietàDebito" type="m730:Debito_Type" minOccurs="0"/></code>

element **Primo_Modulo_PL_Type/AltriDati**

<p>diagram</p>	
<p>namespace</p>	<p>urn:www.agenziaentrate.gov.it:specificheTecniche:sco:730:v1</p>
<p>type</p>	<p>m730:Altri_Dati_Type</p>
<p>properties</p>	<p>isRef 0 minOcc 0 maxOcc 1 content complex</p>
<p>children</p>	<p>m730:ResiduoCreditoPrimaCasa m730:ResiduoCreditoOccupazione m730:ResiduoCreditoSisma m730:ResiduoCreditoFondiPensione m730:ResiduoCreditoMediazioni m730:TotSpeseSanitarieRateizzate m730:RedditoAgevolazioniFiscali</p>
<p>source</p>	<pre><xs:element name="AltriDati" type="m730:Altri_Dati_Type" minOccurs="0"/></pre>

element **Primo_Modulo_PL_Type/DatiF24IMU**

<p>diagram</p>	
<p>namespace</p>	<p>urn:www.agenziaentrate.gov.it:specificheTecniche:sco:730:v1</p>

type	m730:Dati_F24_Imu_Type
properties	isRef 0 minOcc 0 maxOcc 1 content complex
children	m730:ImportoIrpef m730:CodAddReg m730:ImportoAddReg m730:CodiceAddCom m730:ImportoAddCom m730:ImportoCedolare m730:m730Totale
source	<pre><xs:element name="DatiF24IMU" type="m730:Dati_F24_Imu_Type" minOccurs="0"/></pre>

element **Primo_Modulo_PL_Type/CredImpEster**

diagram	
namespace	urn:www.agenziaentrate.gov.it:specificheTecniche:sco:730:v1
type	m730:Cred_Imp_Estero_Type
properties	isRef 0 minOcc 0 maxOcc 1 content complex
children	m730:Anno m730:TotCredito m730:CreditoStato
source	<pre><xs:element name="CredImpEster" type="m730:Cred_Imp_Estero_Type" minOccurs="0"/></pre>

complexType **PrimoModulo_Oneri_Type**

diagram	
namespace	urn:www.agenziaentrate.gov.it:specificheTecniche:sco:730:v1
children	m730:SpeseDetrazioni m730:SpeseDeduzioni m730:InterventoRecuperoPatrimonioEdilizio m730:DatiCatastaliRecuperoPatrimonioEdilizio m730:InterventoRisparmioEnergetico m730:CanoniLocazione m730:DatiAltreDetrazioni
used by	element Oneri_Type/PrimoModulo
source	<pre> <xs:complexType name="PrimoModulo_Oneri_Type"> <xs:sequence> <xs:element name="SpeseDetrazioni" type="m730:Detrazioni_Type" minOccurs="0"/> <xs:element name="SpeseDeduzioni" type="m730:Deduzioni_Type" minOccurs="0"/> <xs:element name="InterventoRecuperoPatrimonioEdilizio" type="m730:Intervento_Recupero_Patrimonio_Edilizio_Type" minOccurs="0" maxOccurs="4"/> <xs:element name="DatiCatastaliRecuperoPatrimonioEdilizio" type="m730:Sezione_Dati_Catastali_Recupero_Patrimonio_Edilizi o_Type" minOccurs="0"/> <xs:element name="InterventoRisparmioEnergetico" type="m730:Intervento_Risparmio_Energetico_Type" minOccurs="0" maxOccurs="3"/> <xs:element name="CanoniLocazione" type="m730:Detrazioni_Canoni_Locazione_Type" minOccurs="0"/> <xs:element name="DatiAltreDetrazioni" type="m730:Dati_Altre_Detrazioni_Type" minOccurs="0"/> </xs:sequence> </xs:complexType> </pre>

element **PrimoModulo_Oneri_Type/SpeseDetrazioni**

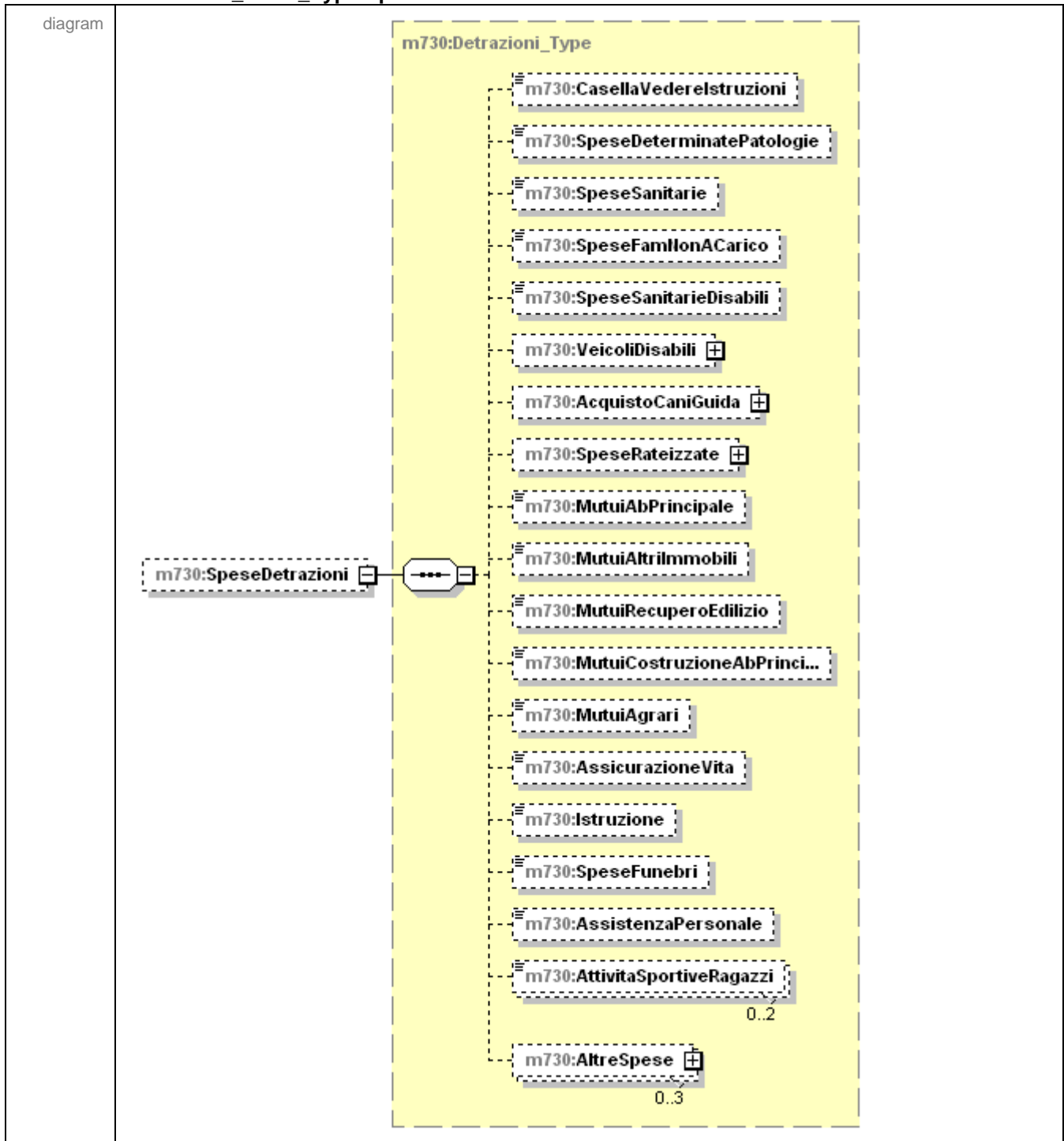

namespace	urn:www.agenziaentrate.gov.it:specificheTecniche:sco:730:v1
type	m730:Detrazioni_Type
properties	isRef 0 minOcc 0 maxOcc 1 content complex
children	m730:CasellaVedereIstruzioni m730:SpeseDeterminatePatologie m730:SpeseSanitarie m730:SpeseFamNonACarico m730:SpeseSanitarieDisabili m730:VeicoliDisabili m730:AcquistoCaniGuida m730:SpeseRateizzate

	m730:MutuiAbPrincipale m730:MutuiAltrimmobili m730:MutuiRecuperoEdilizio m730:MutuiCostruzioneAbPrincipRecuperoEdilizio m730:MutuiAgrari m730:AssicurazioneVita m730:Istruzione m730:SpeseFunebrj m730:AssistenzaPersonale m730:AttivitaSportiveRagazzi m730:AltreSpese
source	<code><xs:element name="SpeseDetrazioni" type="m730:Detrazioni_Type" minOccurs="0"/></code>

element **PrimoModulo_Oneri_Type/SpeseDeduzioni**

diagram	
namespace	urn:www.agenziaentrate.gov.it:specificheTecniche:sco:730:v1
type	m730:Deduzioni_Type
properties	isRef 0 minOcc 0 maxOcc 1 content complex
children	m730:ContributiPrevAss m730:AssegnoConiuge m730:ContributiColf m730:ErogazioniIstituzioniReligiose m730:SpesePortatoriHandicap m730:AltriOneri m730:DeducibilitaOrdinaria m730:LavoratoriPrimaOccupazione m730:FondiInSquilibrioFinanziario m730:FamiliariACarico m730:FondoPensioneDipendentiPubblici
source	<code><xs:element name="SpeseDeduzioni" type="m730:Deduzioni_Type" minOccurs="0"/></code>

element **PrimoModulo_Oneri_Type/InterventoRecuperoPatrimonioEdilizio**

<p>diagram</p>	
<p>namespace</p>	<p>urn:www.agenziaentrate.gov.it:specificheTecniche:sco:730:v1</p>
<p>type</p>	<p>m730:Intervento Recupero Patrimonio Edilizio Type</p>
<p>properties</p>	<p>isRef 0 minOcc 0 maxOcc 4 content complex</p>
<p>children</p>	<p>m730:Anno m730:Periodo2006 m730:CodiceFiscale m730:CasellaVederelstruzioni m730:CodiceSituazioniParticolari m730:AnnoSituazioniParticolari m730:RideterminazioneRate m730:NRate m730:Spesa m730:NOrdinelmmobile</p>
<p>source</p>	<pre><xs:element name="InterventoRecuperoPatrimonioEdilizio" type="m730:Intervento_Recupero_Patrimonio_Edilizio_Type" minOccurs="0" maxOccurs="4"/></pre>

element **PrimoModulo_Oneri_Type/DatiCatastaliRecuperoPatrimonioEdilizio**

<p>diagram</p>	
<p>namespace</p>	<p>urn:www.agenziaentrate.gov.it:specificheTecniche:sco:730:v1</p>
<p>type</p>	<p>m730:Sezione Dati Catastali Recupero Patrimonio Edilizio Type</p>

properties	isRef 0 minOcc 0 maxOcc 1 content complex
children	m730:DatiCatastaliRecuperoPatrimonioEdilizio m730:DatiRegistrazioneAccatastamentoRecuperoPatrimonio_Edilizio
source	<pre><xs:element name="DatiCatastaliRecuperoPatrimonioEdilizio" type="m730:Sezione_Dati_Catastali_Recupero_Patrimonio_Edilizio_Type" minOccurs="0"/></pre>

element **PrimoModulo_Oneri_Type/InterventoRisparmioEnergetico**

diagram	
namespace	urn:www.agenziaentrate.gov.it:specificheTecniche:sco:730:v1
type	m730:Intervento_Risparmio_Energetico_Type
properties	isRef 0 minOcc 0 maxOcc 3 content complex
children	m730:TipoIntervento m730:Anno m730:CasiParticolari m730:RideterminazioneRate m730:RipartizioneRate m730:NumeroRata m730:Spesa
source	<pre><xs:element name="InterventoRisparmioEnergetico" type="m730:Intervento_Risparmio_Energetico_Type" minOccurs="0" maxOccurs="3"/></pre>

element **PrimoModulo_Oneri_Type/CanoniLocazione**

diagram	
---------	--

namespace	urn:www.agenziaentrate.gov.it:specificheTecniche:sco:730:v1
type	m730:Detrazioni_Canoni_Locazione_Type
properties	isRef 0 minOcc 0 maxOcc 1 content complex
children	m730:InquiliniAbitazionePrincipale m730:DipendentiTrasferiti
source	<pre><xs:element name="CanoniLocazione" type="m730:Detrazioni_Canoni_Locazione_Type" minOccurs="0"/></pre>

element [PrimoModulo_Oneri_Type/DatiAltreDetrazioni](#)

diagram	
namespace	urn:www.agenziaentrate.gov.it:specificheTecniche:sco:730:v1
type	m730:Dati_Altre_Detrazioni_Type
properties	isRef 0 minOcc 0 maxOcc 1 content complex
children	m730:SpeseCaniGuida m730:SpeseAcquistoMobiliElettTVPC m730:AltreDetrazioni
source	<pre><xs:element name="DatiAltreDetrazioni" type="m730:Dati_Altre_Detrazioni_Type" minOccurs="0"/></pre>

complexType [Prospetto_Liquidazione_Type](#)

diagram	
namespace	urn:www.agenziaentrate.gov.it:specificheTecniche:sco:730:v1
children	m730:PrimoModulo m730:Modulo
used by	element Dati_Contabili_Type/ProspettoLiquidazione
source	<pre><xs:complexType name="Prospetto_Liquidazione_Type"> <xs:sequence> <xs:element name="PrimoModulo" type="m730:Primo_Modulo_PL_Type"/> <xs:element name="Modulo" type="m730:Modulo_PL_Type" maxOccurs="∞"/> </xs:sequence> </xs:complexType></pre>

```

minOccurs="0" maxOccurs="unbounded"/>
</xs:sequence>
</xs:complexType>

```

element **Prospetto_Liquidazione_Type/PrimoModulo**

diagram	
namespace	urn:www.agenziaentrate.gov.it:specificheTecniche:sco:730:v1
type	m730:Primo_Modulo_PL_Type
properties	isRef 0 content complex
children	m730:RiepilogoRedditi m730:ImpostaLorda m730:DetrazioniCrediti m730:ImpostaNetta m730:Addizionali m730:CedolareSecca m730:ContributoSolidarieta m730:LiquidazioneImposte m730:AltriDati m730:DatiF24IMU m730:CredImpEestero
source	<pre><xs:element name="PrimoModulo" type="m730:Primo_Modulo_PL_Type"/></pre>

element **Prospetto_Liquidazione_Type/Modulo**

diagram	
---------	--

namespace	urn:www.agenziaentrate.gov.it:specificheTecniche:sco:730:v1
type	m730:Modulo_PL_Type
properties	isRef 0 minOcc 0 maxOcc unbounded content complex
children	m730:CredImpEstero
source	<pre><xs:element name="Modulo" type="m730:Modulo_PL_Type" minOccurs="0" maxOccurs="unbounded"/></pre>

complexType Redditi_Capitale_Type

diagram	
namespace	urn:www.agenziaentrate.gov.it:specificheTecniche:sco:730:v1
children	m730:Utili m730:AltriRedditiDiCapitale m730:LavoroAutonomo m730:RedditiDiversi m730:RedditiDiversiDetraz
used by	element Modulo_Altri_Redditi_Type/RedditiDiCapitale
source	<pre><xs:complexType name="Redditi_Capitale_Type"> <xs:sequence> <xs:element name="Utili" type="m730:Altri_Redditi_Utili_Type" minOccurs="0"/> <xs:element name="AltriRedditiDiCapitale" type="m730:Sezione_Altri_Redd_Type" minOccurs="0"/> <xs:element name="LavoroAutonomo" type="m730:Altri_Redditi_Lavoro_Autonomo_Type" minOccurs="0"/> <xs:element name="RedditiDiversi" type="m730:Altri_Redditi_Diversi_Type" minOccurs="0"/> <xs:element name="RedditiDiversiDetraz" type="m730:Altri_Redditi_Diversi_Detr_Type" minOccurs="0"/> </xs:sequence> </xs:complexType></pre>

element **Redditi_Capitale_Type/Utili**

diagram	
namespace	urn:www.agenziaentrate.gov.it:specificheTecniche:sco:730:v1
type	m730:Altri_Redditi_Utili_Type
properties	isRef 0 minOcc 0 maxOcc 1 content complex
children	m730:Tipo_Reddito m730:RedditiRitenute
source	<pre><xs:element name="Utili" type="m730:Altri_Redditi_Utili_Type" minOccurs="0"/></pre>

element **Redditi_Capitale_Type/AltriRedditiDiCapitale**

diagram	
namespace	urn:www.agenziaentrate.gov.it:specificheTecniche:sco:730:v1
type	m730:Sezione_Altri_Redd_Type
properties	isRef 0 minOcc 0 maxOcc 1 content complex
children	m730:TipoReddito m730:RedditiRitenute
source	<pre><xs:element name="AltriRedditiDiCapitale" type="m730:Sezione_Altri_Redd_Type" minOccurs="0"/></pre>

element **Redditi_Capitale_Type/LavoroAutonomo**

diagram	
namespace	urn:www.agenziaentrate.gov.it:specificheTecniche:sco:730:v1

type	m730:Altri Redditi Lavoro Autonomo Type
properties	isRef 0 minOcc 0 maxOcc 1 content complex
children	m730:TipoReddito m730:RedditiRitenute
source	<pre><xs:element name="LavoroAutonomo" type="m730:Altri_Redditi_Lavoro_Autonomo_Type" minOccurs="0"/></pre>

element [Redditi_Capitale_Type/RedditiDiversi](#)

diagram	
namespace	urn:www.agenziaentrate.gov.it:specificheTecniche:sco:730:v1
type	m730:Altri Redditi Diversi Type
properties	isRef 0 minOcc 0 maxOcc 1 content complex
children	m730:TipoReddito m730:RedditiRitenuteSpese
source	<pre><xs:element name="RedditiDiversi" type="m730:Altri_Redditi_Diversi_Type" minOccurs="0"/></pre>

element [Redditi_Capitale_Type/RedditiDiversiDetraz](#)

diagram	
namespace	urn:www.agenziaentrate.gov.it:specificheTecniche:sco:730:v1
type	m730:Altri Redditi Diversi Detr Type
properties	isRef 0 minOcc 0 maxOcc 1 content complex
children	m730:Tipo_Reddito m730:RedditiRitenuteSpese
source	<pre><xs:element name="RedditiDiversiDetraz" type="m730:Altri_Redditi_Diversi_Detr_Type" minOccurs="0"/></pre>

complexType Redditi_Eredi_Legatari_Type

diagram	
namespace	urn:www.agenziaentrate.gov.it:specificheTecniche:sco:730:v1
type	extension of m730:Tassazione_Separata_Type
properties	base m730:Tassazione_Separata_Type
children	m730:Opzione m730:Anno m730:RedditoRitenute m730:TipoReddito m730:RedditoTotale m730:QuotaImposteSuccessioni
used by	element Redditi Tassazione Separata Type/RedditiErede
source	<pre> <xs:complexType name="Redditi_Eredi_Legatari_Type"> <xs:complexContent> <xs:extension base="m730:Tassazione_Separata_Type"> <xs:sequence> <xs:element name="TipoReddito" type="m730:Tipo_Reddito_Da1a12_Type"/> <xs:element name="RedditoTotale" type="cm:DatoNP_Type" minOccurs="0"/> <xs:element name="QuotaImposteSuccessioni" type="cm:DatoNP_Type" minOccurs="0"/> </xs:sequence> </xs:extension> </xs:complexContent> </xs:complexType> </pre>

element Redditi_Eredi_Legatari_Type/TipoReddito

diagram	
namespace	urn:www.agenziaentrate.gov.it:specificheTecniche:sco:730:v1
type	m730:Tipo_Reddito_Da1a12_Type
properties	isRef 0 content simple

facets	Kind	Value	annotation
	maxLength	2	
	pattern	[1-9]{1}[0-9]*	
	enumeration	1	
	enumeration	2	
	enumeration	3	
	enumeration	4	
	enumeration	5	
	enumeration	6	
	enumeration	7	
	enumeration	8	
	enumeration	9	
	enumeration	10	
	enumeration	11	
	enumeration	12	
source	<pre><xs:element name="TipoReddito" type="m730:Tipo_Reddito_Dala12_Type"/></pre>		

element **Redditi Eredi Legatari_Type/RedditoTotale**

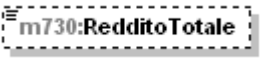
diagram	
namespace	urn:www.agenziaentrate.gov.it:specificheTecniche:sco:730:v1
type	DatoNP_Type
properties	isRef 0 minOcc 0 maxOcc 1 content simple
facets	Kind Value annotation pattern [1-9]{1}[0-9]*
source	<pre><xs:element name="RedditoTotale" type="cm:DatoNP_Type" minOccurs="0"/></pre>

element **Redditi Eredi Legatari_Type/QuotaImposteSuccessioni**

diagram	
namespace	urn:www.agenziaentrate.gov.it:specificheTecniche:sco:730:v1
type	DatoNP_Type
properties	isRef 0 minOcc 0 maxOcc 1 content simple
facets	Kind Value annotation pattern [1-9]{1}[0-9]*
source	<pre><xs:element name="QuotaImposteSuccessioni" type="cm:DatoNP_Type" minOccurs="0"/></pre>

complexType Redditi_Fabbricati_Type

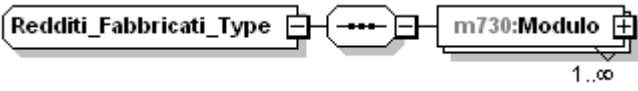
diagram	
namespace	urn:www.agenziaentrate.gov.it:specificheTecniche:sco:730:v1
children	m730:Modulo
used by	element Dati_Contabili_Type/QuadroB
source	<pre><xs:complexType name="Redditi_Fabbricati_Type"> <xs:sequence> <xs:element name="Modulo" type="m730:Modulo_Fabbricato_Type" maxOccurs="unbounded"/> </xs:sequence> </xs:complexType></pre>

element Redditi_Fabbricati_Type/Modulo

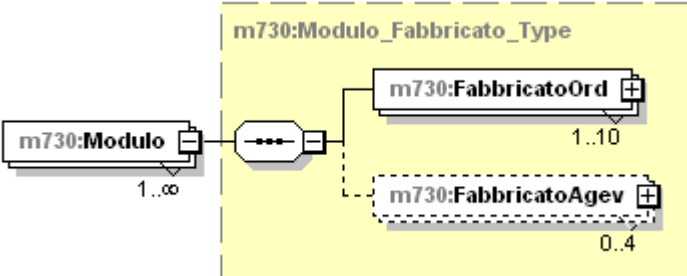
diagram	
namespace	urn:www.agenziaentrate.gov.it:specificheTecniche:sco:730:v1
type	m730:Modulo_Fabbricato_Type
properties	isRef 0 minOcc 1 maxOcc unbounded content complex
children	m730:FabbricatoOrd m730:FabbricatoAgev
source	<pre><xs:element name="Modulo" type="m730:Modulo_Fabbricato_Type" maxOccurs="unbounded"/></pre>

complexType Redditi_Lavoro_Dip_Type

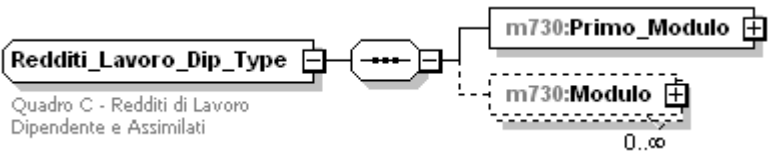
diagram	
namespace	urn:www.agenziaentrate.gov.it:specificheTecniche:sco:730:v1

children	m730:Primo_Modulo m730:Modulo
used by	element Dati_Contabili_Type/QuadroC
annotation	documentation Quadro C - Redditi di Lavoro Dipendente e Assimilati
source	<pre> <xs:complexType name="Redditi_Lavoro_Dip_Type"> <xs:annotation> <xs:documentation>Quadro C - Redditi di Lavoro Dipendente e Assimilati</xs:documentation> </xs:annotation> <xs:sequence> <xs:element name="Primo_Modulo" type="m730:Primo_Modulo_Lavoro_Dip_Type"/> <xs:element name="Modulo" type="m730:Modulo_Lavoro_Dip_Type" minOccurs="0" maxOccurs="unbounded"/> </xs:sequence> </xs:complexType> </pre>

element [Redditi_Lavoro_Dip_Type/Primo_Modulo](#)

diagram	
namespace	urn:www.agenziaentrate.gov.it:specificheTecniche:sco:730:v1
type	m730:Primo_Modulo_Lavoro_Dip_Type
properties	isRef 0 content complex
children	m730:LavoroDipendente m730:PeriodoLavoro m730:IncrementoProduttivita m730:AltriRedditiAssLavDip m730:RitenuteLavoroDipendente m730:SicurezzaDetrazione m730:ContribSolidarietaRiduzione m730:ContribSolidarietaTrattenuto

source	<code><xs:element name="Primo_Modulo" type="m730:Primo_Modulo_Lavoro_Dip_Type"/></code>
--------	---

element **Redditi_Lavoro_Dip_Type/Modulo**

diagram	
namespace	urn:www.agenziaentrate.gov.it:specificheTecniche:sco:730:v1
type	m730:Modulo_Lavoro_Dip_Type
properties	isRef 0 minOcc 0 maxOcc unbounded content complex
children	m730:LavoroDipendente m730:AltriRedditiAssLavDip
source	<code><xs:element name="Modulo" type="m730:Modulo_Lavoro_Dip_Type" minOccurs="0" maxOccurs="unbounded"/></code>

complexType **Redditi_Ritenute_Spese_Type**

diagram	
namespace	urn:www.agenziaentrate.gov.it:specificheTecniche:sco:730:v1
type	extension of m730:Redditi_Ritenute_Type
properties	base m730:Redditi_Ritenute_Type
children	m730:ImportoRedditi m730:ImportoRitenute m730:ImportoSpese
used by	elements Altri_Redditi_Diversi_Type/RedditiRitenuteSpese Altri_Redditi_Diversi_Detr_Type/RedditiRitenuteSpese
source	<code><xs:complexType name="Redditi_Ritenute_Spese_Type"> <xs:complexContent> <xs:extension base="m730:Redditi_Ritenute_Type"> <xs:sequence> <xs:element name="ImportoSpese" type="cm:DatoNP_Type" /> </xs:sequence> </xs:extension> </xs:complexContent> </xs:complexType></code>

	<pre> minOccurs="0"/> </xs:sequence> </xs:extension> </xs:complexContent> </xs:complexType> </pre>
--	---

element **Redditi_Ritenute_Spese_Type/ImportoSpese**

diagram	
namespace	urn:www.agenziaentrate.gov.it:specificheTecniche:sco:730:v1
type	DatoNP_Type
properties	isRef 0 minOcc 0 maxOcc 1 content simple
facets	Kind Value annotation pattern [1-9]{1}[0-9]*
source	<pre> <xs:element name="ImportoSpese" type="cm:DatoNP_Type" minOccurs="0"/> </pre>

complexType **Redditi_Ritenute_Type**

diagram	
namespace	urn:www.agenziaentrate.gov.it:specificheTecniche:sco:730:v1
children	m730:ImportoRedditi m730:ImportoRitenute
used by	elements Altri Redditi Utili Type/RedditiRitenute Sezione Altri Redd Type/RedditiRitenute Altri Redditi Lavoro Autonomo Type/RedditiRitenute Tassazione Separata Type/RedditoRitenute complexType Redditi Ritenute Spese Type
source	<pre> <xs:complexType name="Redditi_Ritenute_Type"> <xs:sequence> <xs:element name="ImportoRedditi" type="cm:DatoNP_Type" minOccurs="0"/> <xs:element name="ImportoRitenute" type="cm:DatoNP_Type" minOccurs="0"/> </xs:sequence> </xs:complexType> </pre>

element **Redditi_Ritenute_Type/ImportoRedditi**

diagram	
---------	--

namespace	urn:www.agenziaentrate.gov.it:specificheTecniche:sco:730:v1
type	DatoNP_Type
properties	isRef 0 minOcc 0 maxOcc 1 content simple
facets	Kind Value annotation pattern [1-9]{1}[0-9]*
source	<pre><xs:element name="ImportoRedditi" type="cm:DatoNP_Type" minOccurs="0"/></pre>

element **Redditi_Ritenute_Type/ImportoRitenute**

diagram	
namespace	urn:www.agenziaentrate.gov.it:specificheTecniche:sco:730:v1
type	DatoNP_Type
properties	isRef 0 minOcc 0 maxOcc 1 content simple
facets	Kind Value annotation pattern [1-9]{1}[0-9]*
source	<pre><xs:element name="ImportoRitenute" type="cm:DatoNP_Type" minOccurs="0"/></pre>

complexType **Redditi_Tassazione_Separata_Type**

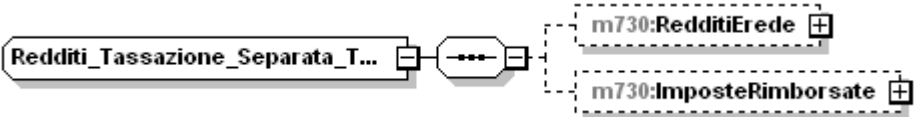
diagram	
namespace	urn:www.agenziaentrate.gov.it:specificheTecniche:sco:730:v1
children	m730:RedditiErede m730:ImposteRimborsate
used by	element Modulo_Altri_Redditi_Type/RedditiTassazioneSeparata
source	<pre><xs:complexType name="Redditi_Tassazione_Separata_Type"> <xs:sequence> <xs:element name="RedditiErede" type="m730:Redditi_Eredi_Legatari_Type" minOccurs="0"/> <xs:element name="ImposteRimborsate" type="m730:Imposte_Rimborsate_Type" minOccurs="0"/> </xs:sequence> </xs:complexType></pre>

element **Redditi_Tassazione_Separata_Type/RedditiErede**

diagram	
namespace	urn:www.agenziaentrate.gov.it:specificheTecniche:sco:730:v1
type	m730:Redditi_Eredi_Legatari_Type
properties	isRef 0 minOcc 0 maxOcc 1 content complex
children	m730:Opzione m730:Anno m730:RedditoRitenute m730:TipoReddito m730:RedditoTotale m730:QuotaImposteSuccessioni
source	<pre><xs:element name="RedditiErede" type="m730:Redditi_Eredi_Legatari_Type" minOccurs="0"/></pre>

element **Redditi_Tassazione_Separata_Type/ImposteRimborsate**

diagram	
namespace	urn:www.agenziaentrate.gov.it:specificheTecniche:sco:730:v1
type	m730:Imposte_Rimborsate_Type
properties	isRef 0 minOcc 0 maxOcc 1 content complex
children	m730:TipoReddito m730:TassazioneSeparata
source	<pre><xs:element name="ImposteRimborsate" type="m730:Imposte_Rimborsate_Type" minOccurs="0"/></pre>

complexType Redditi_Terreni_Type

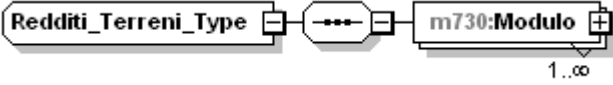
diagram	
namespace	urn:www.agenziaentrate.gov.it:specificheTecniche:sco:730:v1
children	m730:Modulo
used by	element Dati_Contabili_Type/QuadroA
source	<pre><xs:complexType name="Redditi_Terreni_Type"> <xs:sequence> <xs:element name="Modulo" type="m730:Modulo_Terreno_Type" maxOccurs="unbounded"/> </xs:sequence> </xs:complexType></pre>

element Redditi_Terreni_Type/Modulo

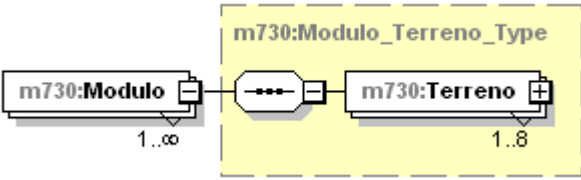
diagram	
namespace	urn:www.agenziaentrate.gov.it:specificheTecniche:sco:730:v1
type	m730:Modulo_Terreno_Type
properties	isRef 0 minOcc 1 maxOcc unbounded content complex
children	m730:Terreno
source	<pre><xs:element name="Modulo" type="m730:Modulo_Terreno_Type" maxOccurs="unbounded"/></pre>

complexType Reddito_Erede_Type

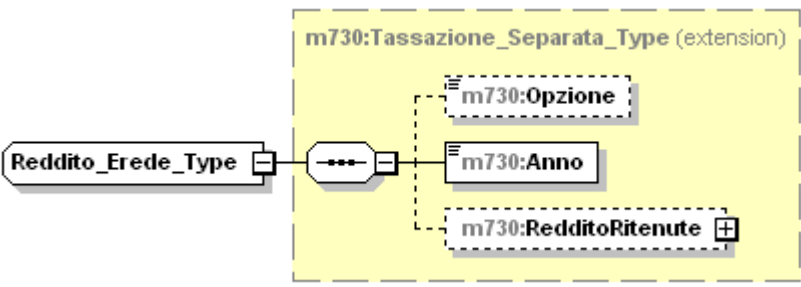
diagram	
namespace	urn:www.agenziaentrate.gov.it:specificheTecniche:sco:730:v1
type	extension of m730:Tassazione_Separata_Type

properties	base m730:Tassazione_Separata_Type
children	m730:Opzione m730:Anno m730:RedditoRitenute
source	<pre><xs:complexType name="Reddito_Erede_Type"> <xs:complexContent> <xs:extension base="m730:Tassazione_Separata_Type"/> </xs:complexContent> </xs:complexType></pre>

complexType **Residenza_Anagrafica_730_Type**

diagram	
namespace	urn:www.agenziaentrate.gov.it:specificheTecniche:sco:730:v1
type	extension of Residenza_Anagrafica_Type
properties	base sc:Residenza_Anagrafica_Type
children	Comune Provincia CodiceComune Indirizzo Cap DataVariazione m730:Tipologia m730:NumCivico m730:Frazione m730:PrimaPresentazione
used by	element Frontespizio_730_Type/ResidenzaAnagrafica
source	<pre><xs:complexType name="Residenza_Anagrafica_730_Type"> <xs:complexContent> <xs:extension base="sc:Residenza_Anagrafica_Type"> <xs:sequence> <xs:element name="Tipologia" type="cm:DatoAN_Type" minOccurs="0"/> <xs:element name="NumCivico" type="cm:DatoAN_Type" minOccurs="0"/> </xs:sequence> </xs:extension> </xs:complexContent> </xs:complexType></pre>

	<pre> minOccurs="0"/> <xs:element name="Frazione" type="cm:DatoAN_Type" minOccurs="0"/> <xs:element name="PrimaPresentazione" type="cm:DatoCB_Type" minOccurs="0"/> </xs:sequence> </xs:extension> </xs:complexContent> </xs:complexType> </pre>
--	---

element **Residenza_Anagrafica_730_Type/Tipologia**

diagram									
namespace	urn:www.agenziaentrate.gov.it:specificheTecniche:sco:730:v1								
type	DatoAN_Type								
properties	<table> <tr><td>isRef</td><td>0</td></tr> <tr><td>minOcc</td><td>0</td></tr> <tr><td>maxOcc</td><td>1</td></tr> <tr><td>content</td><td>simple</td></tr> </table>	isRef	0	minOcc	0	maxOcc	1	content	simple
isRef	0								
minOcc	0								
maxOcc	1								
content	simple								
facets	<table> <tr><td>Kind</td><td>Value</td><td>annotation</td></tr> <tr><td>pattern</td><td>[0-9A-Z-]{1}([0-9A-Z] '\-\. &amp; , \s / ° ^\(\()*)</td><td></td></tr> </table>	Kind	Value	annotation	pattern	[0-9A-Z-]{1}([0-9A-Z] '\-\. & , \s / ° ^\(\()*)			
Kind	Value	annotation							
pattern	[0-9A-Z-]{1}([0-9A-Z] '\-\. & , \s / ° ^\(\()*)								
source	<pre> <xs:element name="Tipologia" type="cm:DatoAN_Type" minOccurs="0"/> </pre>								

element **Residenza_Anagrafica_730_Type/NumCivico**

diagram									
namespace	urn:www.agenziaentrate.gov.it:specificheTecniche:sco:730:v1								
type	DatoAN_Type								
properties	<table> <tr><td>isRef</td><td>0</td></tr> <tr><td>minOcc</td><td>0</td></tr> <tr><td>maxOcc</td><td>1</td></tr> <tr><td>content</td><td>simple</td></tr> </table>	isRef	0	minOcc	0	maxOcc	1	content	simple
isRef	0								
minOcc	0								
maxOcc	1								
content	simple								
facets	<table> <tr><td>Kind</td><td>Value</td><td>annotation</td></tr> <tr><td>pattern</td><td>[0-9A-Z-]{1}([0-9A-Z] '\-\. &amp; , \s / ° ^\(\()*)</td><td></td></tr> </table>	Kind	Value	annotation	pattern	[0-9A-Z-]{1}([0-9A-Z] '\-\. & , \s / ° ^\(\()*)			
Kind	Value	annotation							
pattern	[0-9A-Z-]{1}([0-9A-Z] '\-\. & , \s / ° ^\(\()*)								
source	<pre> <xs:element name="NumCivico" type="cm:DatoAN_Type" minOccurs="0"/> </pre>								

element **Residenza_Anagrafica_730_Type/Frazione**

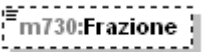
diagram	
namespace	urn:www.agenziaentrate.gov.it:specificheTecniche:sco:730:v1
type	DatoAN_Type

properties	isRef 0 minOcc 0 maxOcc 1 content simple
facets	Kind Value annotation pattern [0-9A-Z-]{1}([0-9A-Z] \\. \\. & , \\s / ^\\ \\(\\))*
source	<code><xs:element name="Frazione" type="cm:DatoAN_Type" minOccurs="0"/></code>

element Residenza_Anagrafica_730_Type/PrimaPresentazione

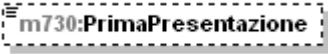
diagram	
namespace	urn:www.agenziaentrate.gov.it:specificheTecniche:sco:730:v1
type	DatoCB_Type
properties	isRef 0 minOcc 0 maxOcc 1 content simple
facets	Kind Value annotation pattern [01]
source	<code><xs:element name="PrimaPresentazione" type="cm:DatoCB_Type" minOccurs="0"/></code>

complexType Residenza_Rappresentante_Type

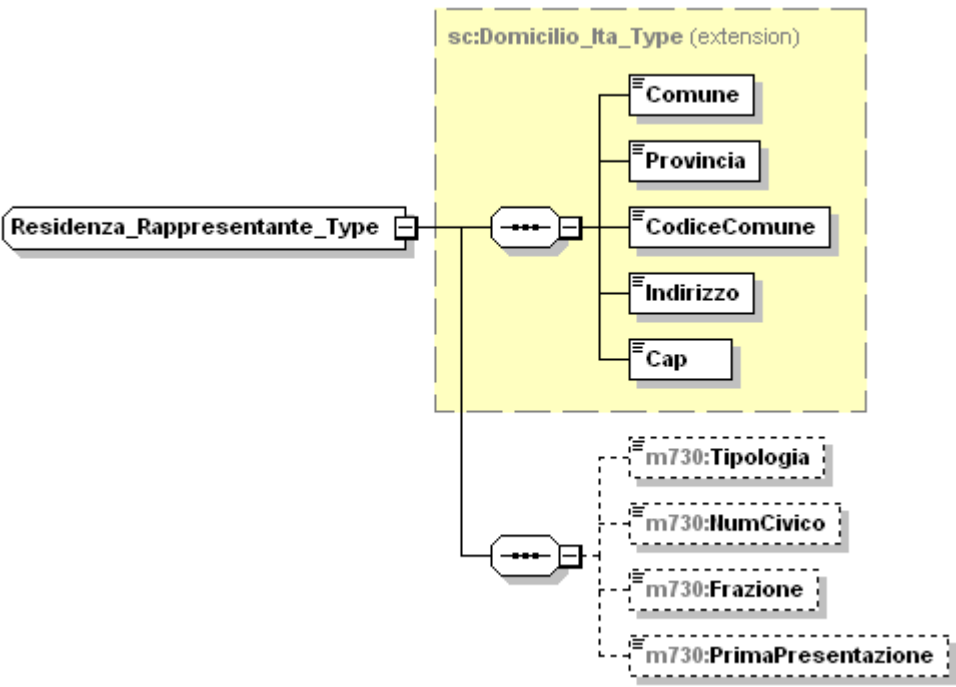
diagram	
namespace	urn:www.agenziaentrate.gov.it:specificheTecniche:sco:730:v1
type	extension of Domicilio_Ita_Type

properties	base sc:Domicilio_Ita_Type
children	Comune Provincia CodiceComune Indirizzo Cap m730:Tipologia m730:NumCivico m730:Frazione m730:PrimaPresentazione
used by	element Frontespizio Dich_Type/Rappresentante/ResidenzaAnagrafica
source	<pre><xs:complexType name="Residenza_Rappresentante_Type"> <xs:complexContent> <xs:extension base="sc:Domicilio_Ita_Type"> <xs:sequence> <xs:element name="Tipologia" type="cm:DatoAN_Type" minOccurs="0"/> <xs:element name="NumCivico" type="cm:DatoAN_Type" minOccurs="0"/> <xs:element name="Frazione" type="cm:DatoAN_Type" minOccurs="0"/> <xs:element name="PrimaPresentazione" type="cm:DatoCB_Type" minOccurs="0"/> </xs:sequence> </xs:extension> </xs:complexContent> </xs:complexType></pre>

element [Residenza_Rappresentante_Type/Tipologia](#)

diagram	
namespace	urn:www.agenziaentrate.gov.it:specificheTecniche:sco:730:v1
type	DatoAN_Type
properties	isRef 0 minOcc 0 maxOcc 1 content simple
facets	Kind Value annotation pattern [0-9A-Z-]{1}([0-9A-Z] \. \& . \s / \^ \(\))*
source	<pre><xs:element name="Tipologia" type="cm:DatoAN_Type" minOccurs="0"/></pre>

element [Residenza_Rappresentante_Type/NumCivico](#)

diagram	
namespace	urn:www.agenziaentrate.gov.it:specificheTecniche:sco:730:v1
type	DatoAN_Type
properties	isRef 0 minOcc 0 maxOcc 1 content simple

facets	Kind Value annotation pattern [0-9A-Z]{1}([0-9A-Z] \. \& , s / \^\ \)*
source	<xs:element name="NumCivico" type="cm:DatoAN_Type" minOccurs="0"/>

element **Residenza_Rappresentante_Type/Frazione**

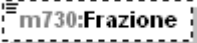
diagram	
namespace	urn:www.agenziaentrate.gov.it:specificheTecniche:sco:730:v1
type	DatoAN_Type
properties	isRef 0 minOcc 0 maxOcc 1 content simple
facets	Kind Value annotation pattern [0-9A-Z]{1}([0-9A-Z] \. \& , s / \^\ \)*
source	<xs:element name="Frazione" type="cm:DatoAN_Type" minOccurs="0"/>

element **Residenza_Rappresentante_Type/PrimaPresentazione**

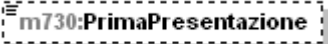
diagram	
namespace	urn:www.agenziaentrate.gov.it:specificheTecniche:sco:730:v1
type	DatoCB_Type
properties	isRef 0 minOcc 0 maxOcc 1 content simple
facets	Kind Value annotation pattern [01]
source	<xs:element name="PrimaPresentazione" type="cm:DatoCB_Type" minOccurs="0"/>

complexType **Residenza_Type**

<p>diagram</p>	
<p>namespace</p>	<p>urn:www.agenziaentrate.gov.it:specificheTecniche:sco:730:v1</p>
<p>children</p>	<p>m730:Comune m730:Provincia m730:CodiceComune m730:Cap m730:Tipologia m730:Indirizzo m730:NumCivico m730:Frazione m730:Email m730:Telefono</p>
<p>used by</p>	<p>element Sostituto_Type/Residenza</p>
<p>source</p>	<pre><xs:complexType name="Residenza_Type"> <xs:sequence> <xs:element name="Comune" type="cm:DatoAN_Type"/> <xs:element name="Provincia" type="cm:PR_Type"/> <xs:element name="CodiceComune" type="cm:DatoAN_Type"/> <xs:element name="Cap" type="cm:DatoAN_Type"/> <xs:element name="Tipologia" type="cm:DatoAN_Type" minOccurs="0"/> <xs:element name="Indirizzo" type="cm:DatoAN_Type"/> <xs:element name="NumCivico" type="cm:DatoAN_Type" minOccurs="0"/> <xs:element name="Frazione" type="cm:DatoAN_Type" minOccurs="0"/> <xs:element name="Email" type="cm:DatoEM_Type" minOccurs="0"/> <xs:element name="Telefono" type="cm:DatoAN_Type" minOccurs="0"/> </xs:sequence> </xs:complexType></pre>

element **Residenza_Type/Comune**

diagram	
namespace	urn:www.agenziaentrate.gov.it:specificheTecniche:sco:730:v1
type	DatoAN_Type
properties	isRef 0 content simple
facets	Kind Value annotation pattern [0-9A-Z-]{1}([0-9A-Z] \\-\\. & _ \\s / ^ \\(\\))*
source	<code><xs:element name="Comune" type="cm:DatoAN_Type"/></code>

element **Residenza_Type/Provincia**

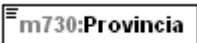
diagram	
namespace	urn:www.agenziaentrate.gov.it:specificheTecniche:sco:730:v1
type	PR_Type
properties	isRef 0 content simple
source	<code><xs:element name="Provincia" type="cm:PR_Type"/></code>

element **Residenza_Type/CodiceComune**

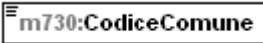
diagram	
namespace	urn:www.agenziaentrate.gov.it:specificheTecniche:sco:730:v1
type	DatoAN_Type
properties	isRef 0 content simple
facets	Kind Value annotation pattern [0-9A-Z-]{1}([0-9A-Z] \\-\\. & _ \\s / ^ \\(\\))*
source	<code><xs:element name="CodiceComune" type="cm:DatoAN_Type"/></code>

element **Residenza_Type/Cap**

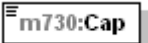
diagram	
namespace	urn:www.agenziaentrate.gov.it:specificheTecniche:sco:730:v1
type	DatoAN_Type
properties	isRef 0 content simple
facets	Kind Value annotation pattern [0-9A-Z-]{1}([0-9A-Z] \\-\\. & _ \\s / ^ \\(\\))*
source	<code><xs:element name="Cap" type="cm:DatoAN_Type"/></code>

element **Residenza_Type/Tipologia**

diagram	
namespace	urn:www.agenziaentrate.gov.it:specificheTecniche:sco:730:v1
type	DatoAN_Type
properties	isRef 0 minOcc 0 maxOcc 1 content simple
facets	Kind Value annotation pattern [0-9A-Z-]{1}([0-9A-Z] \. \& _ \/ ° °\)*
source	<pre><xs:element name="Tipologia" type="cm:DatoAN_Type" minOccurs="0"/></pre>

element **Residenza_Type/Indirizzo**

diagram	
namespace	urn:www.agenziaentrate.gov.it:specificheTecniche:sco:730:v1
type	DatoAN_Type
properties	isRef 0 content simple
facets	Kind Value annotation pattern [0-9A-Z-]{1}([0-9A-Z] \. \& _ \/ ° °\)*
source	<pre><xs:element name="Indirizzo" type="cm:DatoAN_Type"/></pre>

element **Residenza_Type/NumCivico**

diagram	
namespace	urn:www.agenziaentrate.gov.it:specificheTecniche:sco:730:v1
type	DatoAN_Type
properties	isRef 0 minOcc 0 maxOcc 1 content simple
facets	Kind Value annotation pattern [0-9A-Z-]{1}([0-9A-Z] \. \& _ \/ ° °\)*
source	<pre><xs:element name="NumCivico" type="cm:DatoAN_Type" minOccurs="0"/></pre>

element **Residenza_Type/Frazione**

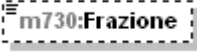
diagram	
namespace	urn:www.agenziaentrate.gov.it:specificheTecniche:sco:730:v1
type	DatoAN_Type
properties	isRef 0 minOcc 0 maxOcc 1 content simple
facets	Kind Value annotation pattern [0-9A-Z-]{1}([0-9A-Z] \\-\\. & _ \\s / ° \\V \\(\\))*
source	<pre><xs:element name="Frazione" type="cm:DatoAN_Type" minOccurs="0"/></pre>

element **Residenza_Type/Email**

diagram	
namespace	urn:www.agenziaentrate.gov.it:specificheTecniche:sco:730:v1
type	DatoEM_Type
properties	isRef 0 minOcc 0 maxOcc 1 content simple
facets	Kind Value annotation pattern [a-zA-Z0-9._%\\-]+@[a-zA-Z0-9\\.\\-]+.[a-zA-Z]{2,4}
source	<pre><xs:element name="Email" type="cm:DatoEM_Type" minOccurs="0"/></pre>

element **Residenza_Type/Telefono**

diagram	
namespace	urn:www.agenziaentrate.gov.it:specificheTecniche:sco:730:v1
type	DatoAN_Type
properties	isRef 0 minOcc 0 maxOcc 1 content simple
facets	Kind Value annotation pattern [0-9A-Z-]{1}([0-9A-Z] \\-\\. & _ \\s / ° \\V \\(\\))*
source	<pre><xs:element name="Telefono" type="cm:DatoAN_Type" minOccurs="0"/></pre>

complexType Residuo_Credito_Compens_AnnoImposta_Type

diagram	
namespace	urn:www.agenziaentrate.gov.it:specificheTecniche:sco:730:v1
type	extension of m730:Residuo_Credito_Compens_Type
properties	base m730:Residuo_Credito_Compens_Type
children	m730:ResiduoPrecedenteDichiarazione m730:CreditoAnno m730:DiCuiCompensatoF24
used by	elements Primo Modulo Crediti Imposta Type/CreditoImpostaMediazioni Crediti Imposta Fabbicati Type/ResiduoFabbicati
source	<pre><xs:complexType name="Residuo_Credito_Compens_AnnoImposta_Type"> <xs:complexContent> <xs:extension base="m730:Residuo_Credito_Compens_Type"/> </xs:complexContent> </xs:complexType></pre>

complexType Residuo_Credito_Compens_Type

diagram	
namespace	urn:www.agenziaentrate.gov.it:specificheTecniche:sco:730:v1
children	m730:ResiduoPrecedenteDichiarazione m730:CreditoAnno m730:DiCuiCompensatoF24
used by	complexType Residuo_Credito_Compens_AnnoImposta_Type
source	<pre><xs:complexType name="Residuo_Credito_Compens_Type"> <xs:sequence> <xs:element name="ResiduoPrecedenteDichiarazione" type="cm:DatoNP_Type" minOccurs="0"/> <xs:element name="CreditoAnno" type="cm:DatoNP_Type" minOccurs="0"/> <xs:element name="DiCuiCompensatoF24" type="cm:DatoNP_Type" minOccurs="0"/> </xs:sequence> </xs:complexType></pre>

element **Residuo_Credito_Compens_Type/ResiduoPrecedenteDichiarazione**

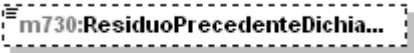
diagram	
namespace	urn:www.agenziaentrate.gov.it:specificheTecniche:sco:730:v1
type	DatoNP_Type
properties	isRef 0 minOcc 0 maxOcc 1 content simple
facets	Kind Value annotation pattern [1-9]{1}[0-9]*
source	<pre><xs:element name="ResiduoPrecedenteDichiarazione" type="cm:DatoNP_Type" minOccurs="0"/></pre>

element **Residuo_Credito_Compens_Type/CreditoAnno**

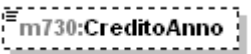
diagram	
namespace	urn:www.agenziaentrate.gov.it:specificheTecniche:sco:730:v1
type	DatoNP_Type
properties	isRef 0 minOcc 0 maxOcc 1 content simple
facets	Kind Value annotation pattern [1-9]{1}[0-9]*
source	<pre><xs:element name="CreditoAnno" type="cm:DatoNP_Type" minOccurs="0"/></pre>

element **Residuo_Credito_Compens_Type/DiCuiCompensatoF24**

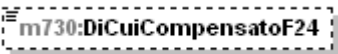
diagram	
namespace	urn:www.agenziaentrate.gov.it:specificheTecniche:sco:730:v1
type	DatoNP_Type
properties	isRef 0 minOcc 0 maxOcc 1 content simple
facets	Kind Value annotation pattern [1-9]{1}[0-9]*
source	<pre><xs:element name="DiCuiCompensatoF24" type="cm:DatoNP_Type" minOccurs="0"/></pre>

complexType **Riepilogo_Redditi_Type**

diagram	
namespace	urn:www.agenziaentrate.gov.it:specificheTecniche:sco:730:v1
children	m730:Dominicali m730:Agrari m730:Fabbricati m730:LavDip m730:AltriRedditi m730:ImponibileCedolare m730:ImponibileCedolareOrdinario m730:ImponibileCedolareAgevolato
used by	element Primo Modulo PL Type/RiepilogoRedditi
source	<pre> <xs:complexType name="Riepilogo_Redditi_Type"> <xs:sequence> <xs:element name="Dominicali" type="cm:DatoNP_Type" minOccurs="0"/> <xs:element name="Agrari" type="cm:DatoNP_Type" minOccurs="0"/> <xs:element name="Fabbricati" type="cm:DatoNP_Type" minOccurs="0"/> <xs:element name="LavDip" type="cm:DatoNP_Type" minOccurs="0"/> <xs:element name="AltriRedditi" type="cm:DatoNP_Type" minOccurs="0"/> <xs:element name="ImponibileCedolare" type="cm:DatoNP_Type" minOccurs="0"/> <xs:element name="ImponibileCedolareOrdinario" type="cm:DatoNP_Type" minOccurs="0"/> <xs:element name="ImponibileCedolareAgevolato" type="cm:DatoNP_Type" minOccurs="0"/> </xs:sequence> </xs:complexType> </pre>

element **Riepilogo_Redditi_Type/Dominicali**

diagram	
---------	--

namespace	urn:www.agenziaentrate.gov.it:specificheTecniche:sco:730:v1
type	DatoNP_Type
properties	isRef 0 minOcc 0 maxOcc 1 content simple
facets	Kind Value annotation pattern [1-9]{1}[0-9]*
source	<code><xs:element name="Dominicali" type="cm:DatoNP_Type" minOccurs="0"/></code>

element Riepilogo_Reddi_Type/Agrari

diagram	
namespace	urn:www.agenziaentrate.gov.it:specificheTecniche:sco:730:v1
type	DatoNP_Type
properties	isRef 0 minOcc 0 maxOcc 1 content simple
facets	Kind Value annotation pattern [1-9]{1}[0-9]*
source	<code><xs:element name="Agrari" type="cm:DatoNP_Type" minOccurs="0"/></code>

element Riepilogo_Reddi_Type/Fabbricati

diagram	
namespace	urn:www.agenziaentrate.gov.it:specificheTecniche:sco:730:v1
type	DatoNP_Type
properties	isRef 0 minOcc 0 maxOcc 1 content simple
facets	Kind Value annotation pattern [1-9]{1}[0-9]*
source	<code><xs:element name="Fabbricati" type="cm:DatoNP_Type" minOccurs="0"/></code>

element Riepilogo_Reddi_Type/LavDip

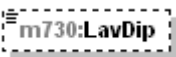
diagram	
namespace	urn:www.agenziaentrate.gov.it:specificheTecniche:sco:730:v1
type	DatoNP_Type

properties	isRef 0 minOcc 0 maxOcc 1 content simple
facets	Kind Value annotation pattern [1-9]{1}[0-9]*
source	<code><xs:element name="LavDip" type="cm:DatoNP_Type" minOccurs="0"/></code>

element Riepilogo_Reddito_Type/AltriRedditi

diagram	
namespace	urn:www.agenziaentrate.gov.it:specificheTecniche:sco:730:v1
type	DatoNP_Type
properties	isRef 0 minOcc 0 maxOcc 1 content simple
facets	Kind Value annotation pattern [1-9]{1}[0-9]*
source	<code><xs:element name="AltriRedditi" type="cm:DatoNP_Type" minOccurs="0"/></code>

element Riepilogo_Reddito_Type/ImponibileCedolare

diagram	
namespace	urn:www.agenziaentrate.gov.it:specificheTecniche:sco:730:v1
type	DatoNP_Type
properties	isRef 0 minOcc 0 maxOcc 1 content simple
facets	Kind Value annotation pattern [1-9]{1}[0-9]*
source	<code><xs:element name="ImponibileCedolare" type="cm:DatoNP_Type" minOccurs="0"/></code>

element Riepilogo_Reddito_Type/ImponibileCedolareOrdinario

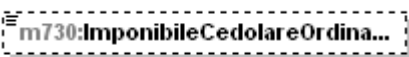
diagram	
namespace	urn:www.agenziaentrate.gov.it:specificheTecniche:sco:730:v1
type	DatoNP_Type
properties	isRef 0 minOcc 0 maxOcc 1

	content simple
facets	Kind Value annotation pattern [1-9]{1}[0-9]*
source	<code><xs:element name="ImponibileCedolareOrdinario" type="cm:DatoNP_Type" minOccurs="0"/></code>

element Riepilogo_Reddi_Type/ImponibileCedolareAgevolato

diagram	
namespace	urn:www.agenziaentrate.gov.it:specificheTecniche:sco:730:v1
type	DatoNP_Type
properties	isRef 0 minOcc 0 maxOcc 1 content simple
facets	Kind Value annotation pattern [1-9]{1}[0-9]*
source	<code><xs:element name="ImponibileCedolareAgevolato" type="cm:DatoNP_Type" minOccurs="0"/></code>

complexType Ritenute_Acconti_Sospesi_Type

diagram	
namespace	urn:www.agenziaentrate.gov.it:specificheTecniche:sco:730:v1
children	m730:CodiceEvento m730:Irpef m730:AddRegionaleIrpef m730:AddComunaleIrpef m730:SostitutivaProduttivita m730:CedolareSecca m730:ContribSolidarieta
used by	element Primo Modulo Acconti Ritenute_Type/RitenuteAccontiSospesi
source	<code><xs:complexType name="Ritenute_Acconti_Sospesi_Type"> <xs:sequence> <xs:element name="CodiceEvento" type="m730:Codice_Evento_Eccezionale_Type" minOccurs="0"/> <xs:element name="Irpef" type="cm:DatoNP_Type" minOccurs="0"/> </xs:sequence> </xs:complexType></code>

	<pre> <xs:element name="AddRegionaleIrpef" type="cm:DatoNP_Type" minOccurs="0"/> <xs:element name="AddComunaleIrpef" type="cm:DatoNP_Type" minOccurs="0"/> <xs:element name="SostitutivaProduttivita" type="cm:DatoNP_Type" minOccurs="0"/> <xs:element name="CedolareSecca" type="cm:DatoNP_Type" minOccurs="0"/> <xs:element name="ContribSolidarieta" type="cm:DatoNP_Type" minOccurs="0"/> </xs:sequence> </xs:complexType> </pre>
--	--

element Ritenute_Acconti_Sospesi_Type/CodiceEvento

diagram																									
namespace	urn:www.agenziaentrate.gov.it:specificheTecniche:sco:730:v1																								
type	m730:Codice Evento Eccezionale Type																								
properties	<table border="0"> <tr><td>isRef</td><td>0</td></tr> <tr><td>minOcc</td><td>0</td></tr> <tr><td>maxOcc</td><td>1</td></tr> <tr><td>content</td><td>simple</td></tr> </table>	isRef	0	minOcc	0	maxOcc	1	content	simple																
isRef	0																								
minOcc	0																								
maxOcc	1																								
content	simple																								
facets	<table border="0"> <thead> <tr> <th>Kind</th> <th>Value</th> <th>annotation</th> </tr> </thead> <tbody> <tr><td>maxLength</td><td>1</td><td></td></tr> <tr><td>pattern</td><td>[1-9]</td><td></td></tr> <tr><td>enumeration</td><td>1</td><td></td></tr> <tr><td>enumeration</td><td>3</td><td></td></tr> <tr><td>enumeration</td><td>4</td><td></td></tr> <tr><td>enumeration</td><td>5</td><td></td></tr> <tr><td>enumeration</td><td>6</td><td></td></tr> </tbody> </table>	Kind	Value	annotation	maxLength	1		pattern	[1-9]		enumeration	1		enumeration	3		enumeration	4		enumeration	5		enumeration	6	
Kind	Value	annotation																							
maxLength	1																								
pattern	[1-9]																								
enumeration	1																								
enumeration	3																								
enumeration	4																								
enumeration	5																								
enumeration	6																								
source	<pre> <xs:element name="CodiceEvento" type="m730:Codice_Evento_Eccezionale_Type" minOccurs="0"/> </pre>																								

element Ritenute_Acconti_Sospesi_Type/Irpef

diagram									
namespace	urn:www.agenziaentrate.gov.it:specificheTecniche:sco:730:v1								
type	DatoNP_Type								
properties	<table border="0"> <tr><td>isRef</td><td>0</td></tr> <tr><td>minOcc</td><td>0</td></tr> <tr><td>maxOcc</td><td>1</td></tr> <tr><td>content</td><td>simple</td></tr> </table>	isRef	0	minOcc	0	maxOcc	1	content	simple
isRef	0								
minOcc	0								
maxOcc	1								
content	simple								
facets	<table border="0"> <thead> <tr> <th>Kind</th> <th>Value</th> <th>annotation</th> </tr> </thead> <tbody> <tr><td>pattern</td><td>[1-9]{1}[0-9]*</td><td></td></tr> </tbody> </table>	Kind	Value	annotation	pattern	[1-9]{1}[0-9]*			
Kind	Value	annotation							
pattern	[1-9]{1}[0-9]*								
source	<pre> <xs:element name="Irpef" type="cm:DatoNP_Type" </pre>								

	<code>minOccurs="0"/></code>
--	---------------------------------

element Ritenute_Acconti_Sospesi_Type/AddRegionaleIrpef

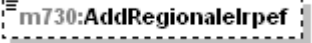
diagram	
namespace	urn:www.agenziaentrate.gov.it:specificheTecniche:sco:730:v1
type	DatoNP_Type
properties	isRef 0 minOcc 0 maxOcc 1 content simple
facets	Kind Value annotation pattern [1-9]{1}[0-9]*
source	<code><xs:element name="AddRegionaleIrpef" type="cm:DatoNP_Type" minOccurs="0"/></code>

element Ritenute_Acconti_Sospesi_Type/AddComunaleIrpef

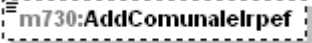
diagram	
namespace	urn:www.agenziaentrate.gov.it:specificheTecniche:sco:730:v1
type	DatoNP_Type
properties	isRef 0 minOcc 0 maxOcc 1 content simple
facets	Kind Value annotation pattern [1-9]{1}[0-9]*
source	<code><xs:element name="AddComunaleIrpef" type="cm:DatoNP_Type" minOccurs="0"/></code>

element Ritenute_Acconti_Sospesi_Type/SostitutivaProduttivita

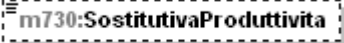
diagram	
namespace	urn:www.agenziaentrate.gov.it:specificheTecniche:sco:730:v1
type	DatoNP_Type
properties	isRef 0 minOcc 0 maxOcc 1 content simple
facets	Kind Value annotation pattern [1-9]{1}[0-9]*
source	<code><xs:element name="SostitutivaProduttivita" type="cm:DatoNP_Type" minOccurs="0"/></code>

element Ritenute_Acconti_Sospesi_Type/CedolareSecca

diagram	
namespace	urn:www.agenziaentrate.gov.it:specificheTecniche:sco:730:v1
type	DatoNP_Type
properties	isRef 0 minOcc 0 maxOcc 1 content simple
facets	Kind Value annotation pattern [1-9]{1}[0-9]*
source	<pre><xs:element name="CedolareSecca" type="cm:DatoNP_Type" minOccurs="0"/></pre>

element Ritenute_Acconti_Sospesi_Type/ContribSolidarieta

diagram	
namespace	urn:www.agenziaentrate.gov.it:specificheTecniche:sco:730:v1
type	DatoNP_Type
properties	isRef 0 minOcc 0 maxOcc 1 content simple
facets	Kind Value annotation pattern [1-9]{1}[0-9]*
source	<pre><xs:element name="ContribSolidarieta" type="cm:DatoNP_Type" minOccurs="0"/></pre>

complexType Ritenute_Lavoro_Dip_Type

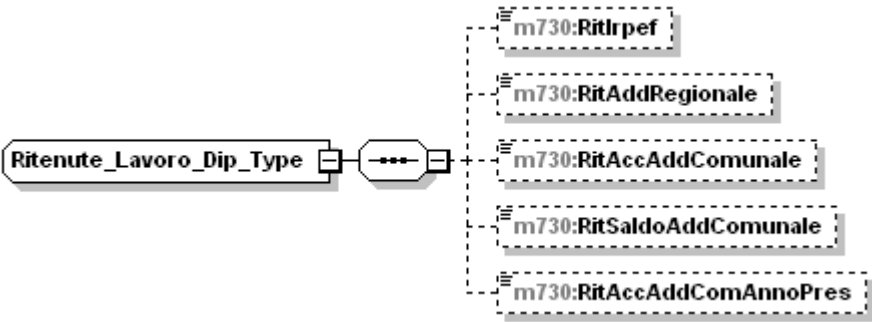
diagram	
namespace	urn:www.agenziaentrate.gov.it:specificheTecniche:sco:730:v1
children	m730:Ritlrpef m730:RitAddRegionale m730:RitAccAddComunale m730:RitSaldoAddComunale m730:RitAccAddComAnnoPres
used by	element Primo Modulo Lavoro Dip Type/RitenuteLavoroDipendente
source	<pre><xs:complexType name="Ritenute_Lavoro_Dip_Type"></pre>

	<pre> <xs:sequence> <xs:element name="RitIrpef" type="cm:DatoNP_Type" minOccurs="0"/> <xs:element name="RitAddRegionale" type="cm:DatoNP_Type" minOccurs="0"/> <xs:element name="RitAccAddComunale" type="cm:DatoNP_Type" minOccurs="0"/> <xs:element name="RitSaldoAddComunale" type="cm:DatoNP_Type" minOccurs="0"/> <xs:element name="RitAccAddComAnnoPres" type="cm:DatoNP_Type" minOccurs="0"/> </xs:sequence> </xs:complexType> </pre>
--	--

element Ritenute_Lavoro_Dip_Type/Ritlrpef

diagram	
namespace	urn:www.agenziaentrato.gov.it:specificheTecniche:sco:730:v1
type	DatoNP_Type
properties	isRef 0 minOcc 0 maxOcc 1 content simple
facets	Kind Value annotation pattern [1-9]{1}[0-9]*
source	<pre> <xs:element name="RitIrpef" type="cm:DatoNP_Type" minOccurs="0"/> </pre>

element Ritenute_Lavoro_Dip_Type/RitAddRegionale

diagram	
namespace	urn:www.agenziaentrato.gov.it:specificheTecniche:sco:730:v1
type	DatoNP_Type
properties	isRef 0 minOcc 0 maxOcc 1 content simple
facets	Kind Value annotation pattern [1-9]{1}[0-9]*
source	<pre> <xs:element name="RitAddRegionale" type="cm:DatoNP_Type" minOccurs="0"/> </pre>

element Ritenute_Lavoro_Dip_Type/RitAccAddComunale

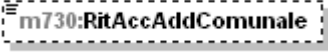
diagram	
namespace	urn:www.agenziaentrate.gov.it:specificheTecniche:sco:730:v1
type	DatoNP_Type
properties	isRef 0 minOcc 0 maxOcc 1 content simple
facets	Kind Value annotation pattern [1-9]{1}[0-9]*
source	<pre><xs:element name="RitAccAddComunale" type="cm:DatoNP_Type" minOccurs="0"/></pre>

element Ritenute_Lavoro_Dip_Type/RitSaldoAddComunale

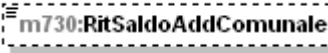
diagram	
namespace	urn:www.agenziaentrate.gov.it:specificheTecniche:sco:730:v1
type	DatoNP_Type
properties	isRef 0 minOcc 0 maxOcc 1 content simple
facets	Kind Value annotation pattern [1-9]{1}[0-9]*
source	<pre><xs:element name="RitSaldoAddComunale" type="cm:DatoNP_Type" minOccurs="0"/></pre>

element Ritenute_Lavoro_Dip_Type/RitAccAddComAnnoPres

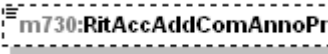
diagram	
namespace	urn:www.agenziaentrate.gov.it:specificheTecniche:sco:730:v1
type	DatoNP_Type
properties	isRef 0 minOcc 0 maxOcc 1 content simple
facets	Kind Value annotation pattern [1-9]{1}[0-9]*
source	<pre><xs:element name="RitAccAddComAnnoPres" type="cm:DatoNP_Type" minOccurs="0"/></pre>

complexType Scelte_Type

diagram	
namespace	urn:www.agenziaentrate.gov.it:specificheTecniche:sco:730:v1
children	m730:Scelte8 m730:Scelte5
used by	elements Dichiarazione Dich Type/Scelte Dichiarazione Con Type/Scelte
source	<pre> <xs:complexType name="Scelte_Type"> <xs:sequence> <xs:element name="Scelte8" type="sce:Scelta8PerMille_Type" minOccurs="0"/> <xs:element name="Scelte5" type="sce:Scelta5PerMille_Type" minOccurs="0"/> </xs:sequence> </xs:complexType> </pre>

element Scelte_Type/Scelte8

diagram	
namespace	urn:www.agenziaentrate.gov.it:specificheTecniche:sco:730:v1
type	sce:Scelta8PerMille_Type
properties	isRef 0 minOcc 0 maxOcc 1 content complex
children	sce:Stato sce:ChiesaCattolica sce:UnioneChieseCristianeAvventiste7giorno sce:AssembleeDiDiolnItalia sce:UnioneDelleChieseMetodisteValdesi sce:ChiesaEvangelicaLuteranaInItalia sce:UnioneComunitaEbraicheInItalia sce:SceltallonEffettuata sce:Anomalia

	sce:UnioneComunitaEbraicheItaliane sce:SceltaNonEffettuata sce:Anomalia
source	<code><xs:element name="Scelte8" type="sce:Scelta8PerMille_Type" minOccurs="0"/></code>

element **Scelte_Type/Scelte5**

diagram	
namespace	urn:www.agenziaentrate.gov.it:specificheTecniche:sco:730:v1
type	sce:Scelta5PerMille_Type
properties	isRef 0 minOcc 0 maxOcc 1 content complex
children	sce:SostegnoVolontariatoNonLucrative sce:RicercaScientifica sce:RicercaSanitaria sce:BeniCulturaliPaesaggistici sce:SostegnoSocialeComune sce:SostegnoAssociazioniSportive sce:SceltaNonEffettuata sce:Anomalia sce:FlagAnomaliaCFbeneficiario
source	<code><xs:element name="Scelte5" type="sce:Scelta5PerMille_Type" minOccurs="0"/></code>

complexType **Sezione_Altri_Redd_Type**

diagram	
namespace	urn:www.agenziaentrate.gov.it:specificheTecniche:sco:730:v1
children	m730:TipoReddito m730:RedditiRitenute
used by	element Redditi_Capitale_Type/AltriRedditiDiCapitale

source	<pre> <xs:complexType name="Sezione_Altri_Redd_Type"> <xs:sequence> <xs:element name="TipoReddito" type="m730:Tipo_Reddito_Dala8_Type"/> <xs:element name="RedditiRitenute" type="m730:Redditi_Ritenute_Type" minOccurs="0"/> </xs:sequence> </xs:complexType> </pre>
--------	---

element Sezione_Altri_Redd_Type/TipoReddito

diagram																																		
namespace	urn:www.agenziaentrate.gov.it:specificheTecniche:sco:730:v1																																	
type	m730:Tipo_Reddito_Dala8_Type																																	
properties	isRef 0 content simple																																	
facets	<table border="1"> <thead> <tr> <th>Kind</th> <th>Value</th> <th>annotation</th> </tr> </thead> <tbody> <tr> <td>maxLength</td> <td>2</td> <td></td> </tr> <tr> <td>pattern</td> <td>[1-9]{1}[0-9]*</td> <td></td> </tr> <tr> <td>enumeration</td> <td>1</td> <td></td> </tr> <tr> <td>enumeration</td> <td>2</td> <td></td> </tr> <tr> <td>enumeration</td> <td>3</td> <td></td> </tr> <tr> <td>enumeration</td> <td>4</td> <td></td> </tr> <tr> <td>enumeration</td> <td>5</td> <td></td> </tr> <tr> <td>enumeration</td> <td>6</td> <td></td> </tr> <tr> <td>enumeration</td> <td>7</td> <td></td> </tr> <tr> <td>enumeration</td> <td>8</td> <td></td> </tr> </tbody> </table>	Kind	Value	annotation	maxLength	2		pattern	[1-9]{1}[0-9]*		enumeration	1		enumeration	2		enumeration	3		enumeration	4		enumeration	5		enumeration	6		enumeration	7		enumeration	8	
Kind	Value	annotation																																
maxLength	2																																	
pattern	[1-9]{1}[0-9]*																																	
enumeration	1																																	
enumeration	2																																	
enumeration	3																																	
enumeration	4																																	
enumeration	5																																	
enumeration	6																																	
enumeration	7																																	
enumeration	8																																	
source	<pre> <xs:element name="TipoReddito" type="m730:Tipo_Reddito_Dala8_Type"/> </pre>																																	

element Sezione_Altri_Redd_Type/RedditiRitenute

diagram	
namespace	urn:www.agenziaentrate.gov.it:specificheTecniche:sco:730:v1
type	m730:Redditi_Ritenute_Type
properties	isRef 0 minOcc 0 maxOcc 1 content complex
children	m730:ImportoRedditi m730:ImportoRitenute

source	<code><xs:element name="RedditiRitenute" type="m730:Redditi_Ritenute_Type" minOccurs="0"/></code>
--------	---

complexType Sezione_Dati_Catastali_Recupero_Patrimonio_Edilizio_Type

diagram	
namespace	urn:www.agenziaentrate.gov.it:specificheTecniche:sco:730:v1
children	m730:DatiCatastaliRecuperoPatrimonioEdilizio m730:DatiRegistrazioneAccatastamentoRecuperoPatrimonio_Edilizio
used by	elements PrimoModulo_Oneri_Type/DatiCatastaliRecuperoPatrimonioEdilizio Modulo_Oneri_Type/DatiCatastaliRecuperoPatrimonioEdilizio
source	<pre> <xs:complexType name="Sezione_Dati_Catastali_Recupero_Patrimonio_Edilizio_Type" > <xs:sequence> <xs:element name="DatiCatastaliRecuperoPatrimonioEdilizio" maxOccurs="2"> <xs:complexType> <xs:complexContent> <xs:extension base="m730:Dati_Catastali_Recupero_Patrimonio_Edilizio_Type"/> </xs:complexContent> </xs:complexType> </xs:element> <xs:element name="DatiRegistrazioneAccatastamentoRecuperoPatrimonio_Edilizio" type="m730:Dati_Registrazione_Accatastamento_Recupero_Patrimonio_Edilizio_Type" minOccurs="0"/> </xs:sequence> </xs:complexType> </pre>

element

Sezione Dati Catastali Recupero Patrimonio Edilizio Type/DatiCatastaliRecuperoPatrimonioEdilizio

<p>diagram</p>	
<p>namespace</p>	<p>urn:www.agenziaentrate.gov.it:specificheTecniche:sco:730:v1</p>
<p>type</p>	<p>extension of m730:Dati Catastali Recupero Patrimonio Edilizio Type</p>
<p>properties</p>	<p>isRef 0 minOcc 1 maxOcc 2 content complex</p>
<p>children</p>	<p>m730:NOrdImmibile m730:COPescaraCondominio m730:CodiceComune m730:TerreniUrbano m730:InteroPorzione m730:SezioneUrbanaComuneCatastale m730:Foglio m730:Particella m730:Subalterno</p>
<p>source</p>	<pre><xs:element name="DatiCatastaliRecuperoPatrimonioEdilizio" maxOccurs="2"> <xs:complexType> <xs:complexContent> <xs:extension base="m730:Dati_Catastali_Recupero_Patrimonio_Edilizio_Type"/ > </xs:complexContent> </xs:complexType> </xs:element></pre>

element

Sezione_Dati_Catastali_Recupero_Patrimonio_Edilizio_Type/DatiRegistrazioneAccatastamentoRecuperoPatrimonio_Edilizio

diagram	
namespace	urn:www.agenziaentrate.gov.it:specificheTecniche:sco:730:v1
type	m730:Dati_Registrazione_Accatastamento_Recupero_Patrimonio_Edilizio_Type
properties	isRef 0 minOcc 0 maxOcc 1 content complex
children	m730:NOrdImmobile m730:COPescaraCondominio m730:EstremiRegistrazioneContratto m730:DataDomandaAccatastamento m730:NumeroDomandaAccatastamento m730:CodiceUfficioDomandaAccatastamento
source	<pre><xs:element name="DatiRegistrazioneAccatastamentoRecuperoPatrimonio_Edilizio" type="m730:Dati_Registrazione_Accatastamento_Recupero_Patrimonio_Edilizio_Type" minOccurs="0"/></pre>

complexType Soggetto_Assistenza_FiscaliDoc_type

diagram	
namespace	urn:www.agenziaentrate.gov.it:specificheTecniche:sco:730:v1
children	m730:DataConsegna m730:TipologiaSoggettoAssFisc m730:SostitutoCF m730:DatiCafDoc m730:DatiProfessionistaDoc m730:DatiAssociazioneDoc
used by	element Documento_730_Type/SoggettoAssFiscaleDoc

source

```
<xs:complexType name="Soggetto_Assistenza_FiscaliDoc_type">
  <xs:sequence>
    <xs:element name="DataConsegna" type="cm:DatoDT_Type"/>
    <xs:element name="TipologiaSoggettoAssFisc"
type="m730:Tipologia_Soggetto_AssFisc_Type"/>
    <xs:choice>
      <xs:element name="SostitutoCF" type="cm:DatoCF_Type"/>
      <xs:element name="DatiCafDoc">
        <xs:complexType>
          <xs:complexContent>
            <xs:extension base="m730:Dati_CAF_Type">
              <xs:sequence>
                <xs:element name="CFResponsabile"
type="cm:DatoCF_Type"/>
                <xs:element name="CognomeResponsabile"
type="cm:DatoAN_Type"/>
                <xs:element name="NomeResponsabile"
type="cm:DatoAN_Type"/>
              </xs:sequence>
            </xs:extension>
          </xs:complexContent>
        </xs:complexType>
      </xs:element>
      <xs:element name="DatiProfessionistaDoc">
        <xs:complexType>
          <xs:complexContent>
            <xs:extension
base="m730:Dati_Professionista_Type">
              <xs:sequence>
                <xs:element name="DatiNascitaProfessionista"
type="m730:Dati_Nascita_PF_Type"/>
              </xs:sequence>
            </xs:extension>
          </xs:complexContent>
        </xs:complexType>
      </xs:element>
      <xs:element name="DatiAssociazioneDoc">
        <xs:complexType>
          <xs:complexContent>
            <xs:extension
base="m730:Dati_Associazioni_Professionale_Type">
              <xs:sequence>
                <xs:element name="DatiNascitaProfessionista"
type="m730:Dati_Nascita_PF_Type"/>
              </xs:sequence>
            </xs:extension>
          </xs:complexContent>
        </xs:complexType>
      </xs:element>
    </xs:choice>
  </xs:sequence>
</xs:complexType>
```

	<pre> </xs:complexType> </xs:element> </xs:choice> </xs:sequence> </xs:complexType> </pre>
--	--

element Soggetto_Assistenza_FiscaliDoc_type/DataConsegna

diagram										
namespace	urn:www.agenziaentrate.gov.it:specificheTecniche:sco:730:v1									
type	DatoDT_Type									
properties	isRef 0 content simple									
facets	<table border="0"> <tr> <td>Kind</td> <td>Value</td> <td>annotation</td> </tr> <tr> <td>length</td> <td>8</td> <td></td> </tr> <tr> <td>pattern</td> <td colspan="2">(((0[1-9][12][0-9]3[01])(0[13578]10 12)(\d{4})) ((0[1-9][12][0-9]30)(0[469]11)(\d{4})) (0[1-9][10-9]2[0-8](02)(\d{4})) ((29)(02)([02468][048]00)) ((29)(02)([13579][26]00)) ((29)(02)([0-9][0-9][48])) ((29)(02)([0-9][2468][048])) ((29)(02)([0-9][0-9][13579][26]))))</td> </tr> </table>	Kind	Value	annotation	length	8		pattern	(((0[1-9][12][0-9]3[01])(0[13578]10 12)(\d{4})) ((0[1-9][12][0-9]30)(0[469]11)(\d{4})) (0[1-9][10-9]2[0-8](02)(\d{4})) ((29)(02)([02468][048]00)) ((29)(02)([13579][26]00)) ((29)(02)([0-9][0-9][48])) ((29)(02)([0-9][2468][048])) ((29)(02)([0-9][0-9][13579][26]))))	
Kind	Value	annotation								
length	8									
pattern	(((0[1-9][12][0-9]3[01])(0[13578]10 12)(\d{4})) ((0[1-9][12][0-9]30)(0[469]11)(\d{4})) (0[1-9][10-9]2[0-8](02)(\d{4})) ((29)(02)([02468][048]00)) ((29)(02)([13579][26]00)) ((29)(02)([0-9][0-9][48])) ((29)(02)([0-9][2468][048])) ((29)(02)([0-9][0-9][13579][26]))))									
source	<code><xs:element name="DataConsegna" type="cm:DatoDT_Type"/></code>									

element Soggetto_Assistenza_FiscaliDoc_type/TipologiaSoggettoAssFisc

diagram																						
namespace	urn:www.agenziaentrate.gov.it:specificheTecniche:sco:730:v1																					
type	m730:Tipologia_Soggetto_AssFisc_Type																					
properties	isRef 0 content simple																					
facets	<table border="0"> <tr> <td>Kind</td> <td>Value</td> <td>annotation</td> </tr> <tr> <td>maxLength</td> <td>1</td> <td></td> </tr> <tr> <td>pattern</td> <td colspan="2">[1-9]</td> </tr> <tr> <td>enumeration</td> <td>1</td> <td></td> </tr> <tr> <td>enumeration</td> <td>2</td> <td></td> </tr> <tr> <td>enumeration</td> <td>3</td> <td></td> </tr> <tr> <td>enumeration</td> <td>4</td> <td></td> </tr> </table>	Kind	Value	annotation	maxLength	1		pattern	[1-9]		enumeration	1		enumeration	2		enumeration	3		enumeration	4	
Kind	Value	annotation																				
maxLength	1																					
pattern	[1-9]																					
enumeration	1																					
enumeration	2																					
enumeration	3																					
enumeration	4																					
source	<code><xs:element name="TipologiaSoggettoAssFisc" type="m730:Tipologia_Soggetto_AssFisc_Type"/></code>																					

element Soggetto_Assistenza_FiscaliDoc_type/SostitutoCF

diagram	
namespace	urn:www.agenziaentrate.gov.it:specificheTecniche:sco:730:v1
type	DatoCF_Type

properties	isRef 0 content simple	
facets	Kind Value pattern [0-9]{11}[A-Z]{6}[0-9LMNPQRSTUUV]{2}[A-Z]{1}[0-9LMNPQRSTUUV]{2}[A-Z]{1}[0-9LMNPQRSTUUV]{3}[A-Z]{1}	annotation
source	<code><xs:element name="SostitutoCF" type="cm:DatoCF_Type"/></code>	

element **Soggetto_Assistenza_FiscaliDoc_type/DatiCafDoc**

diagram		
namespace	urn:www.agenziaentrate.gov.it:specificheTecniche:sco:730:v1	
type	extension of m730:Dati_CAF_Type	
properties	isRef 0 content complex	
children	m730:CFCaf m730:DenominazioneCaf m730:NumeroAlbo m730:CFResponsabile m730:CognomeResponsabile m730:NomeResponsabile	
source	<pre> <xs:element name="DatiCafDoc"> <xs:complexType> <xs:complexContent> <xs:extension base="m730:Dati_CAF_Type"> <xs:sequence> <xs:element name="CFResponsabile" type="cm:DatoCF_Type"/> <xs:element name="CognomeResponsabile" type="cm:DatoAN_Type"/> <xs:element name="NomeResponsabile" type="cm:DatoAN_Type"/> </xs:sequence> </xs:extension> </xs:complexContent> </xs:complexType> </xs:element> </pre>	

element **Soggetto_Assistenza_FiscaliDoc_type/DatiCafDoc/CFResponsabile**

diagram	
namespace	urn:www.agenziaentrate.gov.it:specificheTecniche:sco:730:v1
type	DatoCF_Type
properties	isRef 0 content simple
facets	Kind Value annotation pattern [0-9]{11}[A-Z]{6}[0-9LMNPQRSTUVWXYZ]{2}[A-Z]{1}[0-9LMNPQRSTUVWXYZ]{2}[A-Z]{1}[0-9LMNPQRSTUVWXYZ]{3}[A-Z]{1}
source	<code><xs:element name="CFResponsabile" type="cm:DatoCF_Type"/></code>

element **Soggetto_Assistenza_FiscaliDoc_type/DatiCafDoc/CognomeResponsabile**

diagram	
namespace	urn:www.agenziaentrate.gov.it:specificheTecniche:sco:730:v1
type	DatoAN_Type
properties	isRef 0 content simple
facets	Kind Value annotation pattern [0-9A-Z]{1}([0-9A-Z] \. \& , \s / \^ \(\))*
source	<code><xs:element name="CognomeResponsabile" type="cm:DatoAN_Type"/></code>

element **Soggetto_Assistenza_FiscaliDoc_type/DatiCafDoc/NomeResponsabile**

diagram	
namespace	urn:www.agenziaentrate.gov.it:specificheTecniche:sco:730:v1
type	DatoAN_Type
properties	isRef 0 content simple
facets	Kind Value annotation pattern [0-9A-Z]{1}([0-9A-Z] \. \& , \s / \^ \(\))*
source	<code><xs:element name="NomeResponsabile" type="cm:DatoAN_Type"/></code>

element **Soggetto_Assistenza_FiscaliDoc_type/DatiProfessionistaDoc**

diagram	
namespace	urn:www.agenziaentrate.gov.it:specificheTecniche:sco:730:v1
type	extension of m730:Dati Professionista Type
properties	isRef 0 content complex
children	m730:CFProfessionista m730:CognomeProfessionista m730:NomeProfessionista m730:DatiNascitaProfessionista
source	<pre> <xs:element name="DatiProfessionistaDoc"> <xs:complexType> <xs:complexContent> <xs:extension base="m730:Dati_Professionista_Type"> <xs:sequence> <xs:element name="DatiNascitaProfessionista" type="m730:Dati_Nascita_PF_Type"/> </xs:sequence> </xs:extension> </xs:complexContent> </xs:complexType> </xs:element> </pre>

element **Soggetto_Assistenza_FiscaliDoc_type/DatiProfessionistaDoc/DatiNascitaProfessionista**

diagram	
namespace	urn:www.agenziaentrate.gov.it:specificheTecniche:sco:730:v1
type	m730:Dati_Nascita_PF_Type
properties	isRef 0 content complex

children	m730:Sesso m730:DataNascita m730:ComuneNascita m730:ProvinciaNascita
source	<code><xs:element name="DatiNascitaProfessionista" type="m730:Dati_Nascita_PF_Type"/></code>

element **Soggetto_Assistenza_FiscaliDoc_type/DatiAssociazioneDoc**

diagram	<pre> classDiagram class m730DatiAssociazioneDoc class m730Dati_Associazioni_Professionale_Type["m730:Dati_Associazioni_Professionale_Type (extension)"] class m730CFAssociazione["m730:CFAssociazione"] class m730DenominazioneAssociazione["m730:DenominazioneAssociazione"] class m730CFProfessionista["m730:CFProfessionista"] class m730CognomeProfessionista["m730:CognomeProfessionista"] class m730NomeProfessionista["m730:NomeProfessionista"] class m730HomeProfessionista["m730:HomeProfessionista"] class m730DatiNascitaProfessionista["m730:DatiNascitaProfessionista"] m730DatiAssociazioneDoc .. > m730Dati_Associazioni_Professionale_Type m730DatiAssociazioneDoc -- m730DatiNascitaProfessionista m730Dati_Associazioni_Professionale_Type -- m730CFAssociazione m730Dati_Associazioni_Professionale_Type -- m730DenominazioneAssociazione m730Dati_Associazioni_Professionale_Type -- m730CFProfessionista m730Dati_Associazioni_Professionale_Type -- m730CognomeProfessionista m730Dati_Associazioni_Professionale_Type -- m730NomeProfessionista m730Dati_Associazioni_Professionale_Type -- m730HomeProfessionista </pre>
namespace	urn:www.agenziaentrate.gov.it:specificheTecniche:sco:730:v1
type	extension of m730:Dati_Associazioni_Professionale_Type
properties	isRef 0 content complex
children	m730:CFAssociazione m730:DenominazioneAssociazione m730:CFProfessionista m730:CognomeProfessionista m730:NomeProfessionista m730:DatiNascitaProfessionista
source	<pre> <xs:element name="DatiAssociazioneDoc"> <xs:complexType> <xs:complexContent> <xs:extension base="m730:Dati_Associazioni_Professionale_Type"> <xs:sequence> <xs:element name="DatiNascitaProfessionista" type="m730:Dati_Nascita_PF_Type"/> </xs:sequence> </xs:extension> </xs:complexContent> </xs:complexType> </xs:element> </pre>

element **Soggetto_Assistenza_FiscaliDoc_type/DatiAssociazioneDoc/DatiNascitaProfessionista**

diagram	
namespace	urn:www.agenziaentrate.gov.it:specificheTecniche:sco:730:v1
type	m730:Dati_Nascita_PF_Type
properties	isRef 0 content complex
children	m730:Sesso m730:DataNascita m730:ComuneNascita m730:ProvinciaNascita
source	<pre><xs:element name="DatiNascitaProfessionista" type="m730:Dati_Nascita_PF_Type"/></pre>

complexType **Soggetto_Fiscale_730_Type**

diagram	
namespace	urn:www.agenziaentrate.gov.it:specificheTecniche:sco:730:v1
children	m730:CodiceFiscale m730:Email m730:Telefono m730:Cellulare
used by	elements Frontespizio_730_Type/SoggettoFiscale Frontespizio_Dich_Type/Rappresentante/SoggettoFiscale
source	<pre><xs:complexType name="Soggetto_Fiscale_730_Type"> <xs:sequence> <xs:element name="CodiceFiscale" type="cm:DatoCF_Type"/> <xs:element name="Email" type="cm:DatoEM_Type" minOccurs="0"/> <xs:element name="Telefono" type="cm:DatoAN_Type" minOccurs="0"/> <xs:element name="Cellulare" type="cm:DatoAN_Type" minOccurs="0"/> </xs:sequence> </xs:complexType></pre>

element **Soggetto_Fiscale_730_Type/CodiceFiscale**

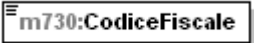
diagram	
namespace	urn:www.agenziaentrate.gov.it:specificheTecniche:sco:730:v1
type	DatoCF_Type
properties	isRef 0 content simple
facets	Kind Value pattern [0-9]{11}[A-Z]{6}[0-9LMNPQRSTU]{2}[A-Z]{1}[0-9LMNPQRSTU]{2}[A-Z]{1}[0-9LMNPQRSTU]{3}[A-Z]{1} annotation
source	<code><xs:element name="CodiceFiscale" type="cm:DatoCF_Type"/></code>

element **Soggetto_Fiscale_730_Type/Email**

diagram	
namespace	urn:www.agenziaentrate.gov.it:specificheTecniche:sco:730:v1
type	DatoEM_Type
properties	isRef 0 minOcc 0 maxOcc 1 content simple
facets	Kind Value pattern [a-zA-Z0-9._%~]+@[a-zA-Z0-9.\-]+\.[a-zA-Z]{2,4} annotation
source	<code><xs:element name="Email" type="cm:DatoEM_Type" minOccurs="0"/></code>

element **Soggetto_Fiscale_730_Type/Telefono**

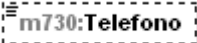
diagram	
namespace	urn:www.agenziaentrate.gov.it:specificheTecniche:sco:730:v1
type	DatoAN_Type
properties	isRef 0 minOcc 0 maxOcc 1 content simple
facets	Kind Value pattern [0-9A-Z-]{1}([0-9A-Z] \. \- \& _ \\s / \^ \(\))* annotation
source	<code><xs:element name="Telefono" type="cm:DatoAN_Type" minOccurs="0"/></code>

element **Soggetto_Fiscale_730_Type/Cellulare**

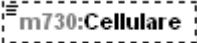
diagram	
namespace	urn:www.agenziaentrate.gov.it:specificheTecniche:sco:730:v1

type	DatoAN_Type
properties	isRef 0 minOcc 0 maxOcc 1 content simple
facets	Kind Value annotation pattern <code>[0-9A-Z]{1}([0-9A-Z] \\. & , \\s / ° \\(\\))*</code>
source	<pre><xs:element name="Cellulare" type="cm:DatoAN_Type" minOccurs="0"/></pre>

complexType **Soglie_Esenzione_Type**

diagram	
namespace	urn:www.agenziaentrate.gov.it:specificheTecniche:sco:730:v1
children	m730:SogliaEsenzione m730:EsenzioneTotale m730:AliquotaAgevolata m730:AltreAgevolazioni
used by	elements Esenzione Add Comunale Type/SogliaEsenzioneAcconto Esenzione Add Comunale Type/SogliaEsenzioneSaldo
source	<pre><xs:complexType name="Soglie_Esenzione_Type"> <xs:choice> <xs:element name="SogliaEsenzione" type="cm:DatoNP_Type" minOccurs="0"/> <xs:element name="EsenzioneTotale" type="cm:DatoCB_Type" minOccurs="0"/> <xs:element name="AliquotaAgevolata" type="cm:DatoPC_Type" minOccurs="0"/> <xs:element name="AltreAgevolazioni" type="cm:DatoCB_Type" minOccurs="0"/> </xs:choice> </xs:complexType></pre>

element **Soglie_Esenzione_Type/SogliaEsenzione**

diagram	
namespace	urn:www.agenziaentrate.gov.it:specificheTecniche:sco:730:v1
type	DatoNP_Type
properties	isRef 0 minOcc 0 maxOcc 1 content simple
facets	Kind Value annotation

	pattern [1-9]{1}[0-9]*
source	<code><xs:element name="SogliaEsenzione" type="cm:DatoNP_Type" minOccurs="0"/></code>

element **Soglie_Esenzione_Type/EsenzioneTotale**

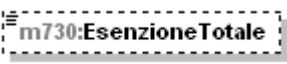
diagram	
namespace	urn:www.agenziaentrate.gov.it:specificheTecniche:sco:730:v1
type	DatoCB_Type
properties	isRef 0 minOcc 0 maxOcc 1 content simple
facets	Kind Value annotation pattern [01]
source	<code><xs:element name="EsenzioneTotale" type="cm:DatoCB_Type" minOccurs="0"/></code>

element **Soglie_Esenzione_Type/AliquotaAgevolata**

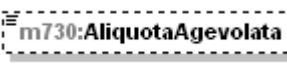
diagram	
namespace	urn:www.agenziaentrate.gov.it:specificheTecniche:sco:730:v1
type	DatoPC_Type
properties	isRef 0 minOcc 0 maxOcc 1 content simple
facets	Kind Value annotation maxLength 16 pattern [0-9]?[0-9](\d{1,3})? 100(,0{1,3})?
source	<code><xs:element name="AliquotaAgevolata" type="cm:DatoPC_Type" minOccurs="0"/></code>

element **Soglie_Esenzione_Type/AltreAgevolazioni**

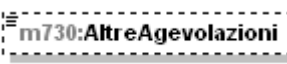
diagram	
namespace	urn:www.agenziaentrate.gov.it:specificheTecniche:sco:730:v1
type	DatoCB_Type
properties	isRef 0 minOcc 0 maxOcc 1 content simple
facets	Kind Value annotation pattern [01]

source	<code><xs:element name="AltreAgevolazioni" type="cm:DatoCB_Type" minOccurs="0"/></code>
--------	---

complexType Sostituto_Type

diagram	
namespace	urn:www.agenziaentrate.gov.it:specificheTecniche:sco:730:v1
children	m730:CodiceFiscale m730:DatiAnagraficiPF m730:DenominazionePNF m730:Residenza m730:Fax m730:CodiceSede
used by	elements Documento 730_Type/Sostituto Documento 730-4/Sostituto
source	<pre> <xs:complexType name="Sostituto_Type"> <xs:sequence> <xs:element name="CodiceFiscale" type="cm:DatoCF_Type"/> <xs:choice> <xs:element name="DatiAnagraficiPF"> <xs:complexType> <xs:sequence> <xs:element name="Cognome" type="cm:DatoAN_Type"/> <xs:element name="Nome" type="cm:DatoAN_Type"/> </xs:sequence> </xs:complexType> </xs:element> <xs:element name="DenominazionePNF" type="cm:DatoAN_Type"/> </xs:choice> <xs:element name="Residenza" type="m730:Residenza_Type"/> <xs:element name="Fax" type="cm:DatoAN_Type" minOccurs="0"/> <xs:element name="CodiceSede" type="cm:DatoAN_Type" minOccurs="0"/> </xs:sequence> </xs:complexType> </pre>

element Sostituto_Type/CodiceFiscale

diagram	
namespace	urn:www.agenziaentrate.gov.it:specificheTecniche:sco:730:v1
type	DatoCF_Type
properties	isRef 0 content simple
facets	Kind Value pattern [0-9]{11}[A-Z]{6}[0-9LMNPQRSTUVWXYZ]{2}[A-Z]{1}[0-9LMNPQRSTUVWXYZ]{2}[A-Z]{1}[0-9LMNPQRSTUVWXYZ]{3}[A-Z]{1} annotation
source	<code><xs:element name="CodiceFiscale" type="cm:DatoCF_Type"/></code>

element Sostituto_Type/DatiAnagraficiPF

diagram	
namespace	urn:www.agenziaentrate.gov.it:specificheTecniche:sco:730:v1
properties	isRef 0 content complex
children	m730:Cognome m730:Nome
source	<pre><xs:element name="DatiAnagraficiPF"> <xs:complexType> <xs:sequence> <xs:element name="Cognome" type="cm:DatoAN_Type"/> <xs:element name="Nome" type="cm:DatoAN_Type"/> </xs:sequence> </xs:complexType> </xs:element></pre>

element Sostituto_Type/DatiAnagraficiPF/Cognome

diagram	
namespace	urn:www.agenziaentrate.gov.it:specificheTecniche:sco:730:v1
type	DatoAN_Type
properties	isRef 0 content simple
facets	Kind Value pattern [0-9A-Z-]{1}([0-9A-Z] \- \. & _ s / ^ \(\))* annotation
source	<code><xs:element name="Cognome" type="cm:DatoAN_Type"/></code>

element **Sostituto_Type/DatiAnagraficiPF/Nome**

diagram	
namespace	urn:www.agenziaentrate.gov.it:specificheTecniche:sco:730:v1
type	DatoAN_Type
properties	isRef 0 content simple
facets	Kind Value annotation pattern [0-9A-Z-]{1}([0-9A-Z] \\- \\. & ; \\s / ^ \\(\\))*
source	<code><xs:element name="Nome" type="cm:DatoAN_Type"/></code>

element **Sostituto_Type/DenominazionePNF**

diagram	
namespace	urn:www.agenziaentrate.gov.it:specificheTecniche:sco:730:v1
type	DatoAN_Type
properties	isRef 0 content simple
facets	Kind Value annotation pattern [0-9A-Z-]{1}([0-9A-Z] \\- \\. & ; \\s / ^ \\(\\))*
source	<code><xs:element name="DenominazionePNF" type="cm:DatoAN_Type"/></code>

element **Sostituto_Type/Residenza**

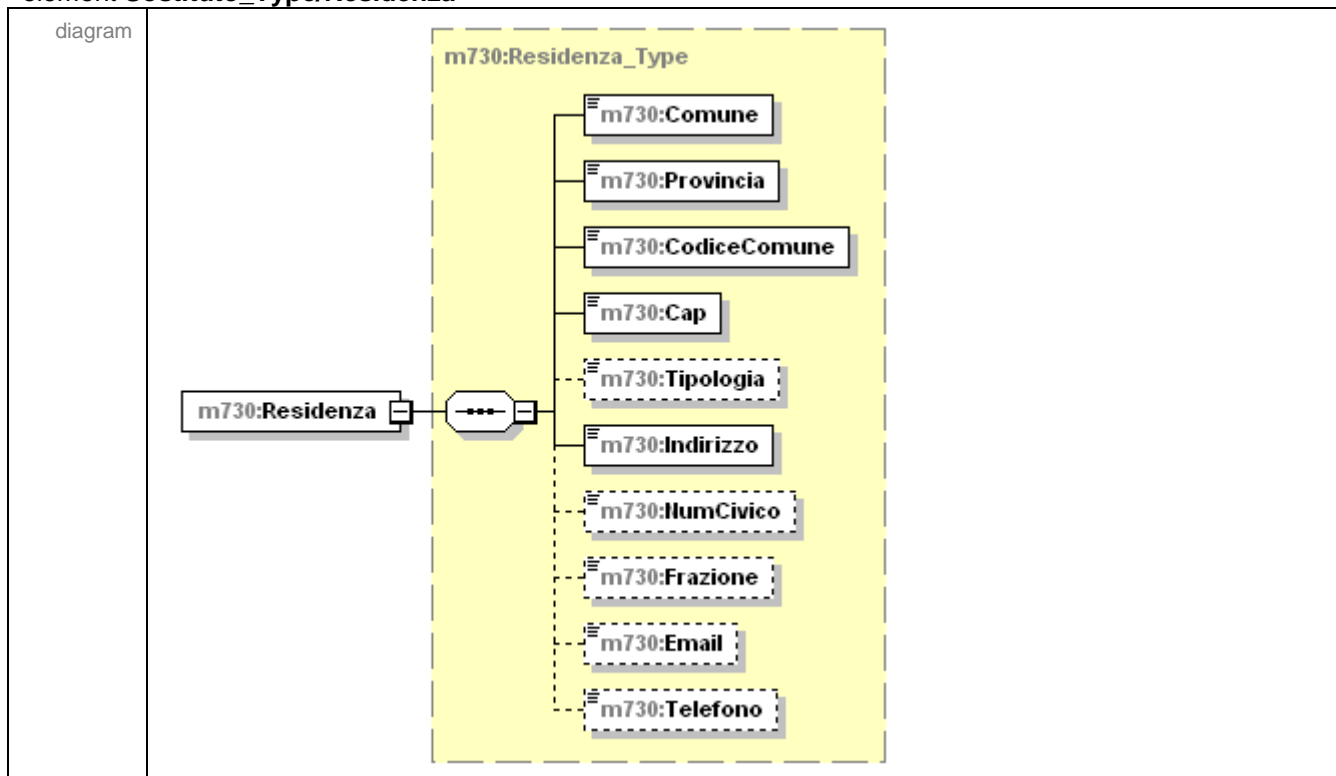

namespace	urn:www.agenziaentrate.gov.it:specificheTecniche:sco:730:v1
type	m730:Residenza_Type
properties	isRef 0 content complex
children	m730:Comune m730:Provincia m730:CodiceComune m730:Cap m730:Tipologia m730:Indirizzo m730:NumCivico m730:Frazione m730:Email m730:Telefono
source	<code><xs:element name="Residenza" type="m730:Residenza_Type"/></code>

element Sostituto_Type/Fax

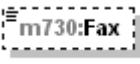
diagram	
namespace	urn:www.agenziaentrate.gov.it:specificheTecniche:sco:730:v1
type	DatoAN_Type
properties	isRef 0 minOcc 0 maxOcc 1 content simple
facets	Kind Value annotation pattern <code>[0-9A-Z]{1}([0-9A-Z] \. \& , \/ ° ^\ ()\)*</code>
source	<code><xs:element name="Fax" type="cm:DatoAN_Type" minOccurs="0"/></code>

element Sostituto_Type/CodiceSede

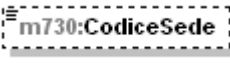
diagram	
namespace	urn:www.agenziaentrate.gov.it:specificheTecniche:sco:730:v1
type	DatoAN_Type
properties	isRef 0 minOcc 0 maxOcc 1 content simple
facets	Kind Value annotation pattern <code>[0-9A-Z]{1}([0-9A-Z] \. \& , \/ ° ^\ ()\)*</code>
source	<code><xs:element name="CodiceSede" type="cm:DatoAN_Type" minOccurs="0"/></code>

complexType Spese_Rateizzate_Anni_Precedenti_Type

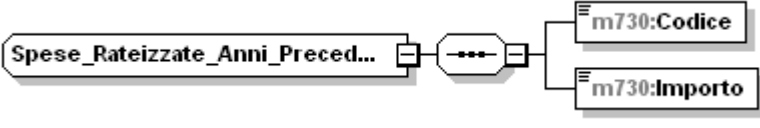
diagram	
namespace	urn:www.agenziaentrate.gov.it:specificheTecniche:sco:730:v1
children	m730:Codice m730:Importo
used by	elements Detrazioni_Type/SpeseRateizzate Detrazioni_Modulo_Type/SpeseRateizzate

source	<pre><xs:complexType name="Spese_Rateizzate_Anni_Precedenti_Type"> <xs:sequence> <xs:element name="Codice" type="m730:Codice_Spese_Rateizzate_Anni_Precedenti_Type"/> <xs:element name="Importo" type="cm:DatoNP_Type"/> </xs:sequence> </xs:complexType></pre>
--------	---

element **Spese_Rateizzate_Anni_Precedenti_Type/Codice**

diagram																
namespace	urn:www.agenziaentrate.gov.it:specificheTecniche:sco:730:v1															
type	m730:Codice Spese Rateizzate Anni Precedenti Type															
properties	isRef 0 content simple															
facets	<table border="1"> <thead> <tr> <th>Kind</th> <th>Value</th> <th>annotation</th> </tr> </thead> <tbody> <tr> <td>pattern</td> <td>[1-9]{1}[0-9]*</td> <td></td> </tr> <tr> <td>enumeration</td> <td>2</td> <td></td> </tr> <tr> <td>enumeration</td> <td>3</td> <td></td> </tr> <tr> <td>enumeration</td> <td>4</td> <td></td> </tr> </tbody> </table>	Kind	Value	annotation	pattern	[1-9]{1}[0-9]*		enumeration	2		enumeration	3		enumeration	4	
Kind	Value	annotation														
pattern	[1-9]{1}[0-9]*															
enumeration	2															
enumeration	3															
enumeration	4															
source	<pre><xs:element name="Codice" type="m730:Codice_Spese_Rateizzate_Anni_Precedenti_Type"/></pre>															

element **Spese_Rateizzate_Anni_Precedenti_Type/Importo**

diagram							
namespace	urn:www.agenziaentrate.gov.it:specificheTecniche:sco:730:v1						
type	DatoNP_Type						
properties	isRef 0 content simple						
facets	<table border="1"> <thead> <tr> <th>Kind</th> <th>Value</th> <th>annotation</th> </tr> </thead> <tbody> <tr> <td>pattern</td> <td>[1-9]{1}[0-9]*</td> <td></td> </tr> </tbody> </table>	Kind	Value	annotation	pattern	[1-9]{1}[0-9]*	
Kind	Value	annotation					
pattern	[1-9]{1}[0-9]*						
source	<pre><xs:element name="Importo" type="cm:DatoNP_Type"/></pre>						

complexType **Spese_Rateizzate_Type**

diagram	
namespace	urn:www.agenziaentrate.gov.it:specificheTecniche:sco:730:v1
children	m730:Codice m730:Importo

used by	elements Detrazioni_Type/AcquistoCaniGuida Detrazioni_Modulo_Type/AcquistoCaniGuida Detrazioni_Type/VeicoliDisabili Detrazioni_Modulo_Type/VeicoliDisabili
source	<pre><xs:complexType name="Spese_Rateizzate_Type"> <xs:sequence> <xs:element name="Codice" type="m730:Codice_Spese_Rateizzate_Type"/> <xs:element name="Importo" type="cm:DatoNP_Type"/> </xs:sequence> </xs:complexType></pre>

element **Spese_Rateizzate_Type/Codice**

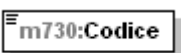
diagram																			
namespace	urn:www.agenziaentrate.gov.it:specificheTecniche:sco:730:v1																		
type	m730:Codice_Spese_Rateizzate_Type																		
properties	isRef 0 content simple																		
facets	<table border="1"> <thead> <tr> <th>Kind</th> <th>Value</th> <th>annotation</th> </tr> </thead> <tbody> <tr> <td>pattern</td> <td>[1-9]{1}[0-9]*</td> <td></td> </tr> <tr> <td>enumeration</td> <td>1</td> <td></td> </tr> <tr> <td>enumeration</td> <td>2</td> <td></td> </tr> <tr> <td>enumeration</td> <td>3</td> <td></td> </tr> <tr> <td>enumeration</td> <td>4</td> <td></td> </tr> </tbody> </table>	Kind	Value	annotation	pattern	[1-9]{1}[0-9]*		enumeration	1		enumeration	2		enumeration	3		enumeration	4	
Kind	Value	annotation																	
pattern	[1-9]{1}[0-9]*																		
enumeration	1																		
enumeration	2																		
enumeration	3																		
enumeration	4																		
source	<pre><xs:element name="Codice" type="m730:Codice_Spese_Rateizzate_Type"/></pre>																		

element **Spese_Rateizzate_Type/Importo**

diagram							
namespace	urn:www.agenziaentrate.gov.it:specificheTecniche:sco:730:v1						
type	DatoNP_Type						
properties	isRef 0 content simple						
facets	<table border="1"> <thead> <tr> <th>Kind</th> <th>Value</th> <th>annotation</th> </tr> </thead> <tbody> <tr> <td>pattern</td> <td>[1-9]{1}[0-9]*</td> <td></td> </tr> </tbody> </table>	Kind	Value	annotation	pattern	[1-9]{1}[0-9]*	
Kind	Value	annotation					
pattern	[1-9]{1}[0-9]*						
source	<pre><xs:element name="Importo" type="cm:DatoNP_Type"/></pre>						

complexType Tassazione_Separata_Type

diagram					
namespace	urn:www.agenziaentrate.gov.it:specificheTecniche:sco:730:v1				
children	m730:Opzione m730:Anno m730:RedditoRitenute				
used by	<table border="0"> <tr> <td>element</td> <td>Imposte Rimborsate Type/TassazioneSeparata</td> </tr> <tr> <td>complexTypes</td> <td>Redditi Eredi Legatari Type Reddito Erede Type</td> </tr> </table>	element	Imposte Rimborsate Type/TassazioneSeparata	complexTypes	Redditi Eredi Legatari Type Reddito Erede Type
element	Imposte Rimborsate Type/TassazioneSeparata				
complexTypes	Redditi Eredi Legatari Type Reddito Erede Type				
source	<pre><xs:complexType name="Tassazione_Separata_Type"> <xs:sequence> <xs:element name="Opzione" type="cm:DatoCB_Type" minOccurs="0"/> <xs:element name="Anno" type="cm:DatoDA_Type"/> <xs:element name="RedditoRitenute" type="m730:Redditi_Ritenute_Type" minOccurs="0"/> </xs:sequence> </xs:complexType></pre>				

element Tassazione_Separata_Type/Opzione

diagram									
namespace	urn:www.agenziaentrate.gov.it:specificheTecniche:sco:730:v1								
type	DatoCB_Type								
properties	<table border="0"> <tr> <td>isRef</td> <td>0</td> </tr> <tr> <td>minOcc</td> <td>0</td> </tr> <tr> <td>maxOcc</td> <td>1</td> </tr> <tr> <td>content</td> <td>simple</td> </tr> </table>	isRef	0	minOcc	0	maxOcc	1	content	simple
isRef	0								
minOcc	0								
maxOcc	1								
content	simple								
facets	<table border="0"> <tr> <td>Kind</td> <td>Value</td> <td>annotation</td> </tr> <tr> <td>pattern</td> <td>[01]</td> <td></td> </tr> </table>	Kind	Value	annotation	pattern	[01]			
Kind	Value	annotation							
pattern	[01]								
source	<pre><xs:element name="Opzione" type="cm:DatoCB_Type" minOccurs="0"/></pre>								

element Tassazione_Separata_Type/Anno

diagram										
namespace	urn:www.agenziaentrate.gov.it:specificheTecniche:sco:730:v1									
type	DatoDA_Type									
properties	<table border="0"> <tr> <td>isRef</td> <td>0</td> </tr> <tr> <td>content</td> <td>simple</td> </tr> </table>	isRef	0	content	simple					
isRef	0									
content	simple									
facets	<table border="0"> <tr> <td>Kind</td> <td>Value</td> <td>annotation</td> </tr> <tr> <td>length</td> <td>4</td> <td></td> </tr> <tr> <td>pattern</td> <td>(18 19 20)[0-9]{2}</td> <td></td> </tr> </table>	Kind	Value	annotation	length	4		pattern	(18 19 20)[0-9]{2}	
Kind	Value	annotation								
length	4									
pattern	(18 19 20)[0-9]{2}									

source	<code><xs:element name="Anno" type="cm:DatoDA_Type"/></code>
--------	--

element Tassazione_Separata_Type/RedditoRitenute

diagram									
namespace	urn:www.agenziaentrate.gov.it:specificheTecniche:sco:730:v1								
type	m730:Redditi_Ritenute_Type								
properties	<table border="0"> <tr><td>isRef</td><td>0</td></tr> <tr><td>minOcc</td><td>0</td></tr> <tr><td>maxOcc</td><td>1</td></tr> <tr><td>content</td><td>complex</td></tr> </table>	isRef	0	minOcc	0	maxOcc	1	content	complex
isRef	0								
minOcc	0								
maxOcc	1								
content	complex								
children	m730:ImportoRedditi m730:ImportoRitenute								
source	<code><xs:element name="RedditoRitenute" type="m730:Redditi_Ritenute_Type" minOccurs="0"/></code>								

complexType Terreno_Type

diagram	
namespace	urn:www.agenziaentrate.gov.it:specificheTecniche:sco:730:v1
children	m730:RedDominicale m730:Titolo m730:RedAgrario m730:GiorniPossesso m730:PercPossesso m730:CanoneVincolistico m730:CasiParticolari m730:CasellaContinuazione
used by	element Modulo_Terreno_Type/Terreno
source	<code><xs:complexType name="Terreno_Type"> <xs:sequence> <xs:element name="RedDominicale" type="cm:DatoNP_Type" minOccurs="0"/></code>

	<pre> <xs:element name="Titolo" type="m730:TitoloTerreno_Type"/> <xs:element name="RedAgrario" type="cm:DatoNP_Type" minOccurs="0"/> <xs:element name="GiorniPossesso" type="cm:DatoGA_Type"/> <xs:element name="PercPossesso" type="cm:DatoPC_Type"/> <xs:element name="CanoneVincolistico" type="cm:DatoNP_Type" minOccurs="0"/> <xs:element name="CasiParticolari" type="m730:CasiParticolariTerreni_Type" minOccurs="0"/> <xs:element name="CasellaContinuazione" type="cm:DatoCB_Type" minOccurs="0"/> </xs:sequence> </xs:complexType> </pre>
--	---

element Terreno_Type/RedDominicale

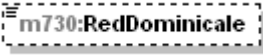
diagram									
namespace	urn:www.agenziaentrate.gov.it:specificheTecniche:sco:730:v1								
type	DatoNP_Type								
properties	<table border="0"> <tr><td>isRef</td><td>0</td></tr> <tr><td>minOcc</td><td>0</td></tr> <tr><td>maxOcc</td><td>1</td></tr> <tr><td>content</td><td>simple</td></tr> </table>	isRef	0	minOcc	0	maxOcc	1	content	simple
isRef	0								
minOcc	0								
maxOcc	1								
content	simple								
facets	<table border="0"> <tr><td>Kind</td><td>Value</td><td>annotation</td></tr> <tr><td>pattern</td><td>[1-9]{1}[0-9]*</td><td></td></tr> </table>	Kind	Value	annotation	pattern	[1-9]{1}[0-9]*			
Kind	Value	annotation							
pattern	[1-9]{1}[0-9]*								
source	<pre><xs:element name="RedDominicale" type="cm:DatoNP_Type" minOccurs="0"/></pre>								

element Terreno_Type/Titolo

diagram																												
namespace	urn:www.agenziaentrate.gov.it:specificheTecniche:sco:730:v1																											
type	m730:TitoloTerreno_Type																											
properties	<table border="0"> <tr><td>isRef</td><td>0</td></tr> <tr><td>content</td><td>simple</td></tr> </table>	isRef	0	content	simple																							
isRef	0																											
content	simple																											
facets	<table border="0"> <tr><td>Kind</td><td>Value</td><td>annotation</td></tr> <tr><td>maxLength</td><td>1</td><td></td></tr> <tr><td>pattern</td><td>[1-9]</td><td></td></tr> <tr><td>enumeration</td><td>1</td><td></td></tr> <tr><td>enumeration</td><td>2</td><td></td></tr> <tr><td>enumeration</td><td>3</td><td></td></tr> <tr><td>enumeration</td><td>4</td><td></td></tr> <tr><td>enumeration</td><td>5</td><td></td></tr> <tr><td>enumeration</td><td>6</td><td></td></tr> </table>	Kind	Value	annotation	maxLength	1		pattern	[1-9]		enumeration	1		enumeration	2		enumeration	3		enumeration	4		enumeration	5		enumeration	6	
Kind	Value	annotation																										
maxLength	1																											
pattern	[1-9]																											
enumeration	1																											
enumeration	2																											
enumeration	3																											
enumeration	4																											
enumeration	5																											
enumeration	6																											

	enumeration 7
source	<code><xs:element name="Titolo" type="m730:TitoloTerreno_Type"/></code>

element Terreno_Type/RedAgrario

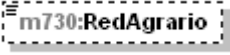
diagram	
namespace	urn:www.agenziaentrate.gov.it:specificheTecniche:sco:730:v1
type	DatoNP_Type
properties	isRef 0 minOcc 0 maxOcc 1 content simple
facets	Kind Value annotation pattern [1-9]{1}[0-9]*
source	<code><xs:element name="RedAgrario" type="cm:DatoNP_Type" minOccurs="0"/></code>

element Terreno_Type/GiorniPossesso

diagram	
namespace	urn:www.agenziaentrate.gov.it:specificheTecniche:sco:730:v1
type	DatoGA_Type
properties	isRef 0 content simple
facets	Kind Value annotation minLength 1 maxLength 3 pattern [1-9]((1-9)[0-9])((12)[0-9][0-9])(3[0-5][0-9])(36[0-5])
source	<code><xs:element name="GiorniPossesso" type="cm:DatoGA_Type"/></code>

element Terreno_Type/PercPossesso

diagram	
namespace	urn:www.agenziaentrate.gov.it:specificheTecniche:sco:730:v1
type	DatoPC_Type
properties	isRef 0 content simple
facets	Kind Value annotation maxLength 16 pattern [0-9]?[0-9](\d{1,3})? 100,(0{1,3})?
source	<code><xs:element name="PercPossesso" type="cm:DatoPC_Type"/></code>

element Terreno_Type/CanoneVincolistico

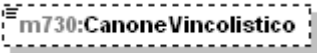
diagram	
namespace	urn:www.agenziaentrate.gov.it:specificheTecniche:sco:730:v1
type	DatoNP_Type
properties	isRef 0 minOcc 0 maxOcc 1 content simple
facets	Kind Value annotation pattern [1-9]{1}[0-9]*
source	<pre><xs:element name="CanoneVincolistico" type="cm:DatoNP_Type" minOccurs="0"/></pre>

element Terreno_Type/CasiParticolari

diagram	
namespace	urn:www.agenziaentrate.gov.it:specificheTecniche:sco:730:v1
type	m730:CasiParticolariTerreni_Type
properties	isRef 0 minOcc 0 maxOcc 1 content simple
facets	Kind Value annotation maxLength 1 pattern [1-9] enumeration 1 enumeration 2 enumeration 3 enumeration 4 enumeration 5 enumeration 6
source	<pre><xs:element name="CasiParticolari" type="m730:CasiParticolariTerreni_Type" minOccurs="0"/></pre>

element Terreno_Type/CasellaContinuazione

diagram	
namespace	urn:www.agenziaentrate.gov.it:specificheTecniche:sco:730:v1
type	DatoCB_Type
properties	isRef 0 minOcc 0 maxOcc 1 content simple

facets	Kind pattern	Value [01]	annotation
source	<code><xs:element name="CasellaContinuazione" type="cm:DatoCB_Type" minOccurs="0"/></code>		

simpleType Anno_Anticipazione_Fondo_Pensione_Type

namespace	urn:www.agenziaentrate.gov.it:specificheTecniche:sco:730:v1		
type	restriction of DatoNP_Type		
properties	base	cm:DatoNP_Type	
used by	element	Crediti Imposta Fondi Pensione Type/AnnoAnticipazione	
facets	Kind length pattern enumeration enumeration enumeration enumeration	Value 4 [1-9]{1}[0-9]* 2008 2009 2010 2011	annotation
source	<pre> <xs:simpleType name="Anno_Anticipazione_Fondo_Pensione_Type"> <xs:restriction base="cm:DatoNP_Type"> <xs:length value="4"/> <xs:enumeration value="2008"/> <xs:enumeration value="2009"/> <xs:enumeration value="2010"/> <xs:enumeration value="2011"/> </xs:restriction> </xs:simpleType> </pre>		

simpleType Anno_Patrimonio_Edilizio_Situazioni_Particolari_Type

namespace	urn:www.agenziaentrate.gov.it:specificheTecniche:sco:730:v1		
type	restriction of DatoNP_Type		
properties	base	cm:DatoNP_Type	
used by	element	Intervento Recupero Patrimonio Edilizio Type/AnnoSituazioniParticolari	
facets	Kind pattern enumeration enumeration enumeration enumeration	Value [1-9]{1}[0-9]* 2007 2008 2009 2010 2011	annotation
source	<pre> <xs:simpleType name="Anno_Patrimonio_Edilizio_Situazioni_Particolari_Type"> <xs:restriction base="cm:DatoNP_Type"> <xs:enumeration value="2007"/> </pre>		

	<pre> <xs:enumeration value="2008"/> <xs:enumeration value="2009"/> <xs:enumeration value="2010"/> <xs:enumeration value="2011"/> </xs:restriction> </xs:simpleType> </pre>
--	---

simpleType Anno_Ricupero_Patrimonio_Edilizio_Type

namespace	urn:www.agenziaentrate.gov.it:specificheTecniche:sco:730:v1																																				
type	restriction of DatoNP_Type																																				
properties	base cm:DatoNP_Type																																				
used by	element Intervento_Ricupero_Patrimonio_Edilizio_Type/Anno																																				
facets	<table border="1"> <thead> <tr> <th>Kind</th> <th>Value</th> <th>annotation</th> </tr> </thead> <tbody> <tr> <td>pattern</td> <td>[1-9]{1}[0-9]*</td> <td></td> </tr> <tr> <td>enumeration</td> <td>2002</td> <td></td> </tr> <tr> <td>enumeration</td> <td>2003</td> <td></td> </tr> <tr> <td>enumeration</td> <td>2004</td> <td></td> </tr> <tr> <td>enumeration</td> <td>2005</td> <td></td> </tr> <tr> <td>enumeration</td> <td>2006</td> <td></td> </tr> <tr> <td>enumeration</td> <td>2007</td> <td></td> </tr> <tr> <td>enumeration</td> <td>2008</td> <td></td> </tr> <tr> <td>enumeration</td> <td>2009</td> <td></td> </tr> <tr> <td>enumeration</td> <td>2010</td> <td></td> </tr> <tr> <td>enumeration</td> <td>2011</td> <td></td> </tr> </tbody> </table>	Kind	Value	annotation	pattern	[1-9]{1}[0-9]*		enumeration	2002		enumeration	2003		enumeration	2004		enumeration	2005		enumeration	2006		enumeration	2007		enumeration	2008		enumeration	2009		enumeration	2010		enumeration	2011	
Kind	Value	annotation																																			
pattern	[1-9]{1}[0-9]*																																				
enumeration	2002																																				
enumeration	2003																																				
enumeration	2004																																				
enumeration	2005																																				
enumeration	2006																																				
enumeration	2007																																				
enumeration	2008																																				
enumeration	2009																																				
enumeration	2010																																				
enumeration	2011																																				
source	<pre> <xs:simpleType name="Anno_Ricupero_Patrimonio_Edilizio_Type"> <xs:restriction base="cm:DatoNP_Type"> <xs:enumeration value="2002"/> <xs:enumeration value="2003"/> <xs:enumeration value="2004"/> <xs:enumeration value="2005"/> <xs:enumeration value="2006"/> <xs:enumeration value="2007"/> <xs:enumeration value="2008"/> <xs:enumeration value="2009"/> <xs:enumeration value="2010"/> <xs:enumeration value="2011"/> </xs:restriction> </xs:simpleType> </pre>																																				

simpleType Anno_Risparmio_Energetico_Type

namespace	urn:www.agenziaentrate.gov.it:specificheTecniche:sco:730:v1
type	restriction of DatoNP_Type
properties	base cm:DatoNP_Type

used by	element Intervento Risparmio Energetico Type/Anno																		
facets	<table border="1"> <thead> <tr> <th>Kind</th> <th>Value</th> <th>annotation</th> </tr> </thead> <tbody> <tr> <td>pattern</td> <td>[1-9]{1}[0-9]*</td> <td></td> </tr> <tr> <td>enumeration</td> <td>2008</td> <td></td> </tr> <tr> <td>enumeration</td> <td>2009</td> <td></td> </tr> <tr> <td>enumeration</td> <td>2010</td> <td></td> </tr> <tr> <td>enumeration</td> <td>2011</td> <td></td> </tr> </tbody> </table>	Kind	Value	annotation	pattern	[1-9]{1}[0-9]*		enumeration	2008		enumeration	2009		enumeration	2010		enumeration	2011	
Kind	Value	annotation																	
pattern	[1-9]{1}[0-9]*																		
enumeration	2008																		
enumeration	2009																		
enumeration	2010																		
enumeration	2011																		
source	<pre><xs:simpleType name="Anno_Risparmio_Energetico_Type"> <xs:restriction base="cm:DatoNP_Type"> <xs:enumeration value="2008"/> <xs:enumeration value="2009"/> <xs:enumeration value="2010"/> <xs:enumeration value="2011"/> </xs:restriction> </xs:simpleType></pre>																		

simpleType [Casella_Codice_Type](#)

namespace	urn:www.agenziaentrate.gov.it:specificheTecniche:sco:730:v1																					
type	restriction of DatoN1_Type																					
properties	base cm:DatoN1_Type																					
used by	element Intervento Recupero Patrimonio Edilizio Type/CodiceSituazioniParticolari																					
facets	<table border="1"> <thead> <tr> <th>Kind</th> <th>Value</th> <th>annotation</th> </tr> </thead> <tbody> <tr> <td>maxLength</td> <td>1</td> <td></td> </tr> <tr> <td>pattern</td> <td>[1-9]</td> <td></td> </tr> <tr> <td>enumeration</td> <td>1</td> <td></td> </tr> <tr> <td>enumeration</td> <td>2</td> <td></td> </tr> <tr> <td>enumeration</td> <td>3</td> <td></td> </tr> <tr> <td>enumeration</td> <td>4</td> <td></td> </tr> </tbody> </table>	Kind	Value	annotation	maxLength	1		pattern	[1-9]		enumeration	1		enumeration	2		enumeration	3		enumeration	4	
Kind	Value	annotation																				
maxLength	1																					
pattern	[1-9]																					
enumeration	1																					
enumeration	2																					
enumeration	3																					
enumeration	4																					
source	<pre><xs:simpleType name="Casella_Codice_Type"> <xs:restriction base="cm:DatoN1_Type"> <xs:enumeration value="1"/> <xs:enumeration value="2"/> <xs:enumeration value="3"/> <xs:enumeration value="4"/> </xs:restriction> </xs:simpleType></pre>																					

simpleType [Casella_Istruzioni_Type](#)

namespace	urn:www.agenziaentrate.gov.it:specificheTecniche:sco:730:v1
type	restriction of DatoN1_Type
properties	base cm:DatoN1_Type
used by	element Intervento Recupero Patrimonio Edilizio Type/CasellaVederelIstruzioni

facets	<table> <thead> <tr> <th>Kind</th> <th>Value</th> <th>annotation</th> </tr> </thead> <tbody> <tr> <td>maxLength</td> <td>1</td> <td></td> </tr> <tr> <td>pattern</td> <td>[1-9]</td> <td></td> </tr> <tr> <td>enumeration</td> <td>1</td> <td></td> </tr> <tr> <td>enumeration</td> <td>2</td> <td></td> </tr> <tr> <td>enumeration</td> <td>3</td> <td></td> </tr> <tr> <td>enumeration</td> <td>4</td> <td></td> </tr> </tbody> </table>	Kind	Value	annotation	maxLength	1		pattern	[1-9]		enumeration	1		enumeration	2		enumeration	3		enumeration	4	
Kind	Value	annotation																				
maxLength	1																					
pattern	[1-9]																					
enumeration	1																					
enumeration	2																					
enumeration	3																					
enumeration	4																					
source	<pre><xs:simpleType name="Casella_Istruzioni_Type"> <xs:restriction base="cm:DatoN1_Type"> <xs:enumeration value="1"/> <xs:enumeration value="2"/> <xs:enumeration value="3"/> <xs:enumeration value="4"/> </xs:restriction> </xs:simpleType></pre>																					

simpleType **Casi_Particolari_Risp_Ener_Type**

namespace	urn:www.agenziaentrate.gov.it:specificheTecniche:sco:730:v1																		
type	restriction of DatoN1_Type																		
properties	base cm:DatoN1_Type																		
used by	element Intervento Risparmio Energetico Type/CasiParticolari																		
facets	<table> <thead> <tr> <th>Kind</th> <th>Value</th> <th>annotation</th> </tr> </thead> <tbody> <tr> <td>maxLength</td> <td>1</td> <td></td> </tr> <tr> <td>pattern</td> <td>[1-9]</td> <td></td> </tr> <tr> <td>enumeration</td> <td>1</td> <td></td> </tr> <tr> <td>enumeration</td> <td>2</td> <td></td> </tr> <tr> <td>enumeration</td> <td>3</td> <td></td> </tr> </tbody> </table>	Kind	Value	annotation	maxLength	1		pattern	[1-9]		enumeration	1		enumeration	2		enumeration	3	
Kind	Value	annotation																	
maxLength	1																		
pattern	[1-9]																		
enumeration	1																		
enumeration	2																		
enumeration	3																		
source	<pre><xs:simpleType name="Casi_Particolari_Risp_Ener_Type"> <xs:restriction base="cm:DatoN1_Type"> <xs:enumeration value="1"/> <xs:enumeration value="2"/> <xs:enumeration value="3"/> </xs:restriction> </xs:simpleType></pre>																		

simpleType **CasiParticolariFabbricato_Type**

namespace	urn:www.agenziaentrate.gov.it:specificheTecniche:sco:730:v1									
type	restriction of DatoN1_Type									
properties	base cm:DatoN1_Type									
used by	element FabbricatoOrd_Type/CasiParticolari									
facets	<table> <thead> <tr> <th>Kind</th> <th>Value</th> <th>annotation</th> </tr> </thead> <tbody> <tr> <td>maxLength</td> <td>1</td> <td></td> </tr> <tr> <td>pattern</td> <td>[1-9]</td> <td></td> </tr> </tbody> </table>	Kind	Value	annotation	maxLength	1		pattern	[1-9]	
Kind	Value	annotation								
maxLength	1									
pattern	[1-9]									

	enumeration 1 enumeration 3 enumeration 4 enumeration 5 enumeration 6
source	<pre> <xs:simpleType name="CasiParticolariFabbricato_Type"> <xs:restriction base="cm:DatoN1_Type"> <xs:enumeration value="1"/> <xs:enumeration value="3"/> <xs:enumeration value="4"/> <xs:enumeration value="5"/> <xs:enumeration value="6"/> </xs:restriction> </xs:simpleType> </pre>

simpleType **CasiParticolariTerreni_Type**

namespace	urn:www.agenziaentrate.gov.it:specificheTecniche:sco:730:v1																											
type	restriction of DatoN1_Type																											
properties	base cm:DatoN1_Type																											
used by	element Terreno_Type/CasiParticolari																											
facets	<table border="1"> <thead> <tr> <th>Kind</th> <th>Value</th> <th>annotation</th> </tr> </thead> <tbody> <tr> <td>maxLength</td> <td>1</td> <td></td> </tr> <tr> <td>pattern</td> <td>[1-9]</td> <td></td> </tr> <tr> <td>enumeration</td> <td>1</td> <td></td> </tr> <tr> <td>enumeration</td> <td>2</td> <td></td> </tr> <tr> <td>enumeration</td> <td>3</td> <td></td> </tr> <tr> <td>enumeration</td> <td>4</td> <td></td> </tr> <tr> <td>enumeration</td> <td>5</td> <td></td> </tr> <tr> <td>enumeration</td> <td>6</td> <td></td> </tr> </tbody> </table>	Kind	Value	annotation	maxLength	1		pattern	[1-9]		enumeration	1		enumeration	2		enumeration	3		enumeration	4		enumeration	5		enumeration	6	
Kind	Value	annotation																										
maxLength	1																											
pattern	[1-9]																											
enumeration	1																											
enumeration	2																											
enumeration	3																											
enumeration	4																											
enumeration	5																											
enumeration	6																											
source	<pre> <xs:simpleType name="CasiParticolariTerreni_Type"> <xs:restriction base="cm:DatoN1_Type"> <xs:enumeration value="1"/> <xs:enumeration value="2"/> <xs:enumeration value="3"/> <xs:enumeration value="4"/> <xs:enumeration value="5"/> <xs:enumeration value="6"/> </xs:restriction> </xs:simpleType> </pre>																											

simpleType **Codice_Altre_Detrazioni_Type**

namespace	urn:www.agenziaentrate.gov.it:specificheTecniche:sco:730:v1
type	restriction of DatoNP_Type

properties	base cm:DatoNP_Type												
used by	element Altre Detrazioni Type/Codice												
facets	<table border="0"> <tr> <td>Kind</td> <td>Value</td> <td>annotation</td> </tr> <tr> <td>pattern</td> <td>[1-9]{1}[0-9]*</td> <td></td> </tr> <tr> <td>enumeration</td> <td>1</td> <td></td> </tr> <tr> <td>enumeration</td> <td>2</td> <td></td> </tr> </table>	Kind	Value	annotation	pattern	[1-9]{1}[0-9]*		enumeration	1		enumeration	2	
Kind	Value	annotation											
pattern	[1-9]{1}[0-9]*												
enumeration	1												
enumeration	2												
source	<pre><xs:simpleType name="Codice_Altre_Detrazioni_Type"> <xs:restriction base="cm:DatoNP_Type"> <xs:enumeration value="1"/> <xs:enumeration value="2"/> </xs:restriction> </xs:simpleType></pre>												

simpleType Codice_Altre_Spese_Type

namespace	urn:www.agenziaentrate.gov.it:specificheTecniche:sco:730:v1																																																												
type	restriction of DatoNP_Type																																																												
properties	base cm:DatoNP_Type																																																												
used by	element Altre Spese Type/Codice																																																												
facets	<table border="0"> <tr> <td>Kind</td> <td>Value</td> <td>annotation</td> </tr> <tr> <td>pattern</td> <td>[1-9]{1}[0-9]*</td> <td></td> </tr> <tr> <td>enumeration</td> <td>17</td> <td></td> </tr> <tr> <td>enumeration</td> <td>18</td> <td></td> </tr> <tr> <td>enumeration</td> <td>19</td> <td></td> </tr> <tr> <td>enumeration</td> <td>20</td> <td></td> </tr> <tr> <td>enumeration</td> <td>21</td> <td></td> </tr> <tr> <td>enumeration</td> <td>22</td> <td></td> </tr> <tr> <td>enumeration</td> <td>23</td> <td></td> </tr> <tr> <td>enumeration</td> <td>24</td> <td></td> </tr> <tr> <td>enumeration</td> <td>25</td> <td></td> </tr> <tr> <td>enumeration</td> <td>26</td> <td></td> </tr> <tr> <td>enumeration</td> <td>27</td> <td></td> </tr> <tr> <td>enumeration</td> <td>28</td> <td></td> </tr> <tr> <td>enumeration</td> <td>29</td> <td></td> </tr> <tr> <td>enumeration</td> <td>30</td> <td></td> </tr> <tr> <td>enumeration</td> <td>31</td> <td></td> </tr> <tr> <td>enumeration</td> <td>32</td> <td></td> </tr> <tr> <td>enumeration</td> <td>33</td> <td></td> </tr> <tr> <td>enumeration</td> <td>34</td> <td></td> </tr> </table>	Kind	Value	annotation	pattern	[1-9]{1}[0-9]*		enumeration	17		enumeration	18		enumeration	19		enumeration	20		enumeration	21		enumeration	22		enumeration	23		enumeration	24		enumeration	25		enumeration	26		enumeration	27		enumeration	28		enumeration	29		enumeration	30		enumeration	31		enumeration	32		enumeration	33		enumeration	34	
Kind	Value	annotation																																																											
pattern	[1-9]{1}[0-9]*																																																												
enumeration	17																																																												
enumeration	18																																																												
enumeration	19																																																												
enumeration	20																																																												
enumeration	21																																																												
enumeration	22																																																												
enumeration	23																																																												
enumeration	24																																																												
enumeration	25																																																												
enumeration	26																																																												
enumeration	27																																																												
enumeration	28																																																												
enumeration	29																																																												
enumeration	30																																																												
enumeration	31																																																												
enumeration	32																																																												
enumeration	33																																																												
enumeration	34																																																												
source	<pre><xs:simpleType name="Codice_Altre_Spese_Type"> <xs:restriction base="cm:DatoNP_Type"> <xs:enumeration value="17"/> <xs:enumeration value="18"/> <xs:enumeration value="19"/> <xs:enumeration value="20"/> </xs:restriction> </xs:simpleType></pre>																																																												

	<pre> <xs:enumeration value="21"/> <xs:enumeration value="22"/> <xs:enumeration value="23"/> <xs:enumeration value="24"/> <xs:enumeration value="25"/> <xs:enumeration value="26"/> <xs:enumeration value="27"/> <xs:enumeration value="28"/> <xs:enumeration value="29"/> <xs:enumeration value="30"/> <xs:enumeration value="31"/> <xs:enumeration value="32"/> <xs:enumeration value="33"/> <xs:enumeration value="34"/> </xs:restriction> </xs:simpleType> </pre>
--	---

simpleType Codice_Altri_Oneri_Type

namespace	urn:www.agenziaentrate.gov.it:specificheTecniche:sco:730:v1																					
type	restriction of DatoNP_Type																					
properties	base cm:DatoNP_Type																					
used by	element Altri_Oneri_Type/Codice																					
facets	<table border="1"> <thead> <tr> <th>Kind</th> <th>Value</th> <th>annotation</th> </tr> </thead> <tbody> <tr> <td>pattern</td> <td>[1-9]{1}[0-9]*</td> <td></td> </tr> <tr> <td>enumeration</td> <td>1</td> <td></td> </tr> <tr> <td>enumeration</td> <td>2</td> <td></td> </tr> <tr> <td>enumeration</td> <td>3</td> <td></td> </tr> <tr> <td>enumeration</td> <td>4</td> <td></td> </tr> <tr> <td>enumeration</td> <td>5</td> <td></td> </tr> </tbody> </table>	Kind	Value	annotation	pattern	[1-9]{1}[0-9]*		enumeration	1		enumeration	2		enumeration	3		enumeration	4		enumeration	5	
Kind	Value	annotation																				
pattern	[1-9]{1}[0-9]*																					
enumeration	1																					
enumeration	2																					
enumeration	3																					
enumeration	4																					
enumeration	5																					
source	<pre> <xs:simpleType name="Codice_Altri_Oneri_Type"> <xs:restriction base="cm:DatoNP_Type"> <xs:enumeration value="1"/> <xs:enumeration value="2"/> <xs:enumeration value="3"/> <xs:enumeration value="4"/> <xs:enumeration value="5"/> </xs:restriction> </xs:simpleType> </pre>																					

simpleType Codice_Evento_Eccezionale_Type

namespace	urn:www.agenziaentrate.gov.it:specificheTecniche:sco:730:v1
type	restriction of DatoN1_Type
properties	base cm:DatoN1_Type

used by	element Ritenute Acconti Sospesi Type/CodiceEvento																								
facets	<table border="1"> <thead> <tr> <th>Kind</th> <th>Value</th> <th>annotation</th> </tr> </thead> <tbody> <tr> <td>maxLength</td> <td>1</td> <td></td> </tr> <tr> <td>pattern</td> <td>[1-9]</td> <td></td> </tr> <tr> <td>enumeration</td> <td>1</td> <td></td> </tr> <tr> <td>enumeration</td> <td>3</td> <td></td> </tr> <tr> <td>enumeration</td> <td>4</td> <td></td> </tr> <tr> <td>enumeration</td> <td>5</td> <td></td> </tr> <tr> <td>enumeration</td> <td>6</td> <td></td> </tr> </tbody> </table>	Kind	Value	annotation	maxLength	1		pattern	[1-9]		enumeration	1		enumeration	3		enumeration	4		enumeration	5		enumeration	6	
Kind	Value	annotation																							
maxLength	1																								
pattern	[1-9]																								
enumeration	1																								
enumeration	3																								
enumeration	4																								
enumeration	5																								
enumeration	6																								
source	<pre><xs:simpleType name="Codice_Evento_Eccezionale_Type"> <xs:restriction base="cm:DatoN1_Type"> <xs:enumeration value="1"/> <xs:enumeration value="3"/> <xs:enumeration value="4"/> <xs:enumeration value="5"/> <xs:enumeration value="6"/> </xs:restriction> </xs:simpleType></pre>																								

simpleType [Codice_Spese_Rateizzate_Anni_Precedenti_Type](#)

namespace	urn:www.agenziaentrate.gov.it:specificheTecniche:sco:730:v1															
type	restriction of DatoNP_Type															
properties	base cm:DatoNP_Type															
used by	element Spese_Rateizzate_Anni_Precedenti_Type/Codice															
facets	<table border="1"> <thead> <tr> <th>Kind</th> <th>Value</th> <th>annotation</th> </tr> </thead> <tbody> <tr> <td>pattern</td> <td>[1-9]{1}[0-9]*</td> <td></td> </tr> <tr> <td>enumeration</td> <td>2</td> <td></td> </tr> <tr> <td>enumeration</td> <td>3</td> <td></td> </tr> <tr> <td>enumeration</td> <td>4</td> <td></td> </tr> </tbody> </table>	Kind	Value	annotation	pattern	[1-9]{1}[0-9]*		enumeration	2		enumeration	3		enumeration	4	
Kind	Value	annotation														
pattern	[1-9]{1}[0-9]*															
enumeration	2															
enumeration	3															
enumeration	4															
source	<pre><xs:simpleType name="Codice_Spese_Rateizzate_Anni_Precedenti_Type"> <xs:restriction base="cm:DatoNP_Type"> <xs:enumeration value="2"/> <xs:enumeration value="3"/> <xs:enumeration value="4"/> </xs:restriction> </xs:simpleType></pre>															

simpleType [Codice_Spese_Rateizzate_Type](#)

namespace	urn:www.agenziaentrate.gov.it:specificheTecniche:sco:730:v1
type	restriction of DatoNP_Type
properties	base cm:DatoNP_Type

used by	element Spese Rateizzate Type/Codice																		
facets	<table border="1"> <thead> <tr> <th>Kind</th> <th>Value</th> <th>annotation</th> </tr> </thead> <tbody> <tr> <td>pattern</td> <td>[1-9]{1}[0-9]*</td> <td></td> </tr> <tr> <td>enumeration</td> <td>1</td> <td></td> </tr> <tr> <td>enumeration</td> <td>2</td> <td></td> </tr> <tr> <td>enumeration</td> <td>3</td> <td></td> </tr> <tr> <td>enumeration</td> <td>4</td> <td></td> </tr> </tbody> </table>	Kind	Value	annotation	pattern	[1-9]{1}[0-9]*		enumeration	1		enumeration	2		enumeration	3		enumeration	4	
Kind	Value	annotation																	
pattern	[1-9]{1}[0-9]*																		
enumeration	1																		
enumeration	2																		
enumeration	3																		
enumeration	4																		
source	<pre><xs:simpleType name="Codice_Spese_Rateizzate_Type"> <xs:restriction base="cm:DatoNP_Type"> <xs:enumeration value="1"/> <xs:enumeration value="2"/> <xs:enumeration value="3"/> <xs:enumeration value="4"/> </xs:restriction> </xs:simpleType></pre>																		

simpleType [CodiceCanone_Type](#)

namespace	urn:www.agenziaentrate.gov.it:specificheTecniche:sco:730:v1																		
type	restriction of DatoN1_Type																		
properties	base cm:DatoN1_Type																		
used by	element FabbricatoOrd_Type/CodiceCanone																		
facets	<table border="1"> <thead> <tr> <th>Kind</th> <th>Value</th> <th>annotation</th> </tr> </thead> <tbody> <tr> <td>maxLength</td> <td>1</td> <td></td> </tr> <tr> <td>pattern</td> <td>[1-9]</td> <td></td> </tr> <tr> <td>enumeration</td> <td>1</td> <td></td> </tr> <tr> <td>enumeration</td> <td>2</td> <td></td> </tr> <tr> <td>enumeration</td> <td>3</td> <td></td> </tr> </tbody> </table>	Kind	Value	annotation	maxLength	1		pattern	[1-9]		enumeration	1		enumeration	2		enumeration	3	
Kind	Value	annotation																	
maxLength	1																		
pattern	[1-9]																		
enumeration	1																		
enumeration	2																		
enumeration	3																		
source	<pre><xs:simpleType name="CodiceCanone_Type"> <xs:restriction base="cm:DatoN1_Type"> <xs:enumeration value="1"/> <xs:enumeration value="2"/> <xs:enumeration value="3"/> </xs:restriction> </xs:simpleType></pre>																		

simpleType [FabbricatoAgev_Numero_Rigo_Type](#)

namespace	urn:www.agenziaentrate.gov.it:specificheTecniche:sco:730:v1									
type	restriction of DatoNP_Type									
properties	base cm:DatoNP_Type									
used by	element FabbricatoAgev_Type/NumeroRigoRiferimento									
facets	<table border="1"> <thead> <tr> <th>Kind</th> <th>Value</th> <th>annotation</th> </tr> </thead> <tbody> <tr> <td>pattern</td> <td>[1-9]{1}[0-9]*</td> <td></td> </tr> <tr> <td>enumeration</td> <td>1</td> <td></td> </tr> </tbody> </table>	Kind	Value	annotation	pattern	[1-9]{1}[0-9]*		enumeration	1	
Kind	Value	annotation								
pattern	[1-9]{1}[0-9]*									
enumeration	1									

	enumeration 2 enumeration 3 enumeration 4 enumeration 5 enumeration 6 enumeration 7 enumeration 8 enumeration 9 enumeration 10
source	<pre> <xs:simpleType name="FabbricatoAgev_Numero_Rigo_Type"> <xs:restriction base="cm:DatoNP_Type"> <xs:enumeration value="1"/> <xs:enumeration value="2"/> <xs:enumeration value="3"/> <xs:enumeration value="4"/> <xs:enumeration value="5"/> <xs:enumeration value="6"/> <xs:enumeration value="7"/> <xs:enumeration value="8"/> <xs:enumeration value="9"/> <xs:enumeration value="10"/> </xs:restriction> </xs:simpleType> </pre>

simpleType Indeterminato_Determinato_Type

namespace	urn:www.agenziaentrate.gov.it:specificheTecniche:sco:730:v1															
type	restriction of DatoN1_Type															
properties	base cm:DatoN1_Type															
used by	element Lavoro Dipendente Type/TipoContratto															
facets	<table border="1"> <thead> <tr> <th>Kind</th> <th>Value</th> <th>annotation</th> </tr> </thead> <tbody> <tr> <td>maxLength</td> <td>1</td> <td></td> </tr> <tr> <td>pattern</td> <td>[1-9]</td> <td></td> </tr> <tr> <td>enumeration</td> <td>1</td> <td></td> </tr> <tr> <td>enumeration</td> <td>2</td> <td></td> </tr> </tbody> </table>	Kind	Value	annotation	maxLength	1		pattern	[1-9]		enumeration	1		enumeration	2	
Kind	Value	annotation														
maxLength	1															
pattern	[1-9]															
enumeration	1															
enumeration	2															
source	<pre> <xs:simpleType name="Indeterminato_Determinato_Type"> <xs:restriction base="cm:DatoN1_Type"> <xs:enumeration value="1"/> <xs:enumeration value="2"/> </xs:restriction> </xs:simpleType> </pre>															

simpleType Integrativo_Type

namespace	urn:www.agenziaentrate.gov.it:specificheTecniche:sco:730:v1
-----------	---

type	restriction of DatoN1_Type																		
properties	base cm:DatoN1_Type																		
used by	elements Documento 730_Type/AltriDati/Integrativo Documento 730-4/AltriDati/Integrativo																		
facets	<table border="1"> <thead> <tr> <th>Kind</th> <th>Value</th> <th>annotation</th> </tr> </thead> <tbody> <tr> <td>maxLength</td> <td>1</td> <td></td> </tr> <tr> <td>pattern</td> <td>[1-9]</td> <td></td> </tr> <tr> <td>enumeration</td> <td>1</td> <td></td> </tr> <tr> <td>enumeration</td> <td>2</td> <td></td> </tr> <tr> <td>enumeration</td> <td>3</td> <td></td> </tr> </tbody> </table>	Kind	Value	annotation	maxLength	1		pattern	[1-9]		enumeration	1		enumeration	2		enumeration	3	
Kind	Value	annotation																	
maxLength	1																		
pattern	[1-9]																		
enumeration	1																		
enumeration	2																		
enumeration	3																		
source	<pre><xs:simpleType name="Integrativo_Type"> <xs:restriction base="cm:DatoN1_Type"> <xs:enumeration value="1"/> <xs:enumeration value="2"/> <xs:enumeration value="3"/> </xs:restriction> </xs:simpleType></pre>																		

simpleType Intero_Porzione_Type

namespace	urn:www.agenziaentrate.gov.it:specificheTecniche:sco:730:v1												
type	restriction of DatoAN_Type												
properties	base cm:DatoAN_Type												
used by	element Dati Catastali Recupero Patrimonio Edilizio_Type/InteroPorzione												
facets	<table border="1"> <thead> <tr> <th>Kind</th> <th>Value</th> <th>annotation</th> </tr> </thead> <tbody> <tr> <td>pattern</td> <td>[0-9A-Z-]{1}([0-9A-Z] \- \. & _ s / ° ^\ ())*</td> <td></td> </tr> <tr> <td>enumeration</td> <td>I</td> <td></td> </tr> <tr> <td>enumeration</td> <td>P</td> <td></td> </tr> </tbody> </table>	Kind	Value	annotation	pattern	[0-9A-Z-]{1}([0-9A-Z] \- \. & _ s / ° ^\ ())*		enumeration	I		enumeration	P	
Kind	Value	annotation											
pattern	[0-9A-Z-]{1}([0-9A-Z] \- \. & _ s / ° ^\ ())*												
enumeration	I												
enumeration	P												
source	<pre><xs:simpleType name="Intero_Porzione_Type"> <xs:restriction base="cm:DatoAN_Type"> <xs:enumeration value="I"/> <xs:enumeration value="P"/> </xs:restriction> </xs:simpleType></pre>												

simpleType Mesi_Type

namespace	urn:www.agenziaentrate.gov.it:specificheTecniche:sco:730:v1												
type	restriction of DatoNP_Type												
properties	base cm:DatoNP_Type												
used by	elements Dati Coniuge_Type/Mesi Dati Primo Figlio_Type/Mesi Dati Primo Figlio_Type/MesiMinore												
facets	<table border="1"> <thead> <tr> <th>Kind</th> <th>Value</th> <th>annotation</th> </tr> </thead> <tbody> <tr> <td>pattern</td> <td>[1-9]{1}[0-9]*</td> <td></td> </tr> <tr> <td>enumeration</td> <td>1</td> <td></td> </tr> <tr> <td>enumeration</td> <td>2</td> <td></td> </tr> </tbody> </table>	Kind	Value	annotation	pattern	[1-9]{1}[0-9]*		enumeration	1		enumeration	2	
Kind	Value	annotation											
pattern	[1-9]{1}[0-9]*												
enumeration	1												
enumeration	2												

	enumeration 3 enumeration 4 enumeration 5 enumeration 6 enumeration 7 enumeration 8 enumeration 9 enumeration 10 enumeration 11 enumeration 12
source	<pre> <xs:simpleType name="Mesi_Type"> <xs:restriction base="cm:DatoNP_Type"> <xs:enumeration value="1"/> <xs:enumeration value="2"/> <xs:enumeration value="3"/> <xs:enumeration value="4"/> <xs:enumeration value="5"/> <xs:enumeration value="6"/> <xs:enumeration value="7"/> <xs:enumeration value="8"/> <xs:enumeration value="9"/> <xs:enumeration value="10"/> <xs:enumeration value="11"/> <xs:enumeration value="12"/> </xs:restriction> </xs:simpleType> </pre>

simpleType Numero_Rata_Risparmi_Energetico_Type

namespace	urn:www.agenziaentrate.gov.it:specificheTecniche:sco:730:v1																		
type	restriction of DatoNP_Type																		
properties	base cm:DatoNP_Type																		
used by	element Intervento_Risparmio_Energetico_Type/NumeroRata																		
facets	<table border="1"> <thead> <tr> <th>Kind</th> <th>Value</th> <th>annotation</th> </tr> </thead> <tbody> <tr> <td>pattern</td> <td>[1-9]{1}[0-9]*</td> <td></td> </tr> <tr> <td>enumeration</td> <td>1</td> <td></td> </tr> <tr> <td>enumeration</td> <td>2</td> <td></td> </tr> <tr> <td>enumeration</td> <td>3</td> <td></td> </tr> <tr> <td>enumeration</td> <td>4</td> <td></td> </tr> </tbody> </table>	Kind	Value	annotation	pattern	[1-9]{1}[0-9]*		enumeration	1		enumeration	2		enumeration	3		enumeration	4	
Kind	Value	annotation																	
pattern	[1-9]{1}[0-9]*																		
enumeration	1																		
enumeration	2																		
enumeration	3																		
enumeration	4																		
source	<pre> <xs:simpleType name="Numero_Rata_Risparmi_Energetico_Type"> <xs:restriction base="cm:DatoNP_Type"> <xs:enumeration value="1"/> <xs:enumeration value="2"/> <xs:enumeration value="3"/> <xs:enumeration value="4"/> </xs:restriction> </pre>																		

	<code></xs:simpleType></code>
--	-------------------------------------

simpleType Numero_Rate5o10_Type

namespace	urn:www.agenziaentrate.gov.it:specificheTecniche:sco:730:v1															
type	restriction of DatoNP_Type															
properties	base cm:DatoNP_Type															
used by	element Crediti Imposta Altri Sisma Abruzzo Type/Rateazione															
facets	<table border="1"> <thead> <tr> <th>Kind</th> <th>Value</th> <th>annotation</th> </tr> </thead> <tbody> <tr> <td>maxLength</td> <td>2</td> <td></td> </tr> <tr> <td>pattern</td> <td>[1-9]{1}[0-9]*</td> <td></td> </tr> <tr> <td>enumeration</td> <td>5</td> <td></td> </tr> <tr> <td>enumeration</td> <td>10</td> <td></td> </tr> </tbody> </table>	Kind	Value	annotation	maxLength	2		pattern	[1-9]{1}[0-9]*		enumeration	5		enumeration	10	
Kind	Value	annotation														
maxLength	2															
pattern	[1-9]{1}[0-9]*															
enumeration	5															
enumeration	10															
source	<pre> <xs:simpleType name="Numero_Rate5o10_Type"> <xs:restriction base="cm:DatoNP_Type"> <xs:maxLength value="2"/> <xs:enumeration value="5"/> <xs:enumeration value="10"/> </xs:restriction> </xs:simpleType> </pre>															

simpleType Numero_RateDa1A2_Type

namespace	urn:www.agenziaentrate.gov.it:specificheTecniche:sco:730:v1															
type	restriction of DatoN1_Type															
properties	base cm:DatoN1_Type															
facets	<table border="1"> <thead> <tr> <th>Kind</th> <th>Value</th> <th>annotation</th> </tr> </thead> <tbody> <tr> <td>maxLength</td> <td>1</td> <td></td> </tr> <tr> <td>pattern</td> <td>[1-9]</td> <td></td> </tr> <tr> <td>enumeration</td> <td>1</td> <td></td> </tr> <tr> <td>enumeration</td> <td>2</td> <td></td> </tr> </tbody> </table>	Kind	Value	annotation	maxLength	1		pattern	[1-9]		enumeration	1		enumeration	2	
Kind	Value	annotation														
maxLength	1															
pattern	[1-9]															
enumeration	1															
enumeration	2															
source	<pre> <xs:simpleType name="Numero_RateDa1A2_Type"> <xs:restriction base="cm:DatoN1_Type"> <xs:enumeration value="1"/> <xs:enumeration value="2"/> </xs:restriction> </xs:simpleType> </pre>															

simpleType Numero_RateDa1A3_Type

namespace	urn:www.agenziaentrate.gov.it:specificheTecniche:sco:730:v1
type	restriction of DatoN1_Type
properties	base cm:DatoN1_Type
used by	element Credito Immobile Sisma Abruzzo Type/NumeroRata

facets	<table border="1"> <thead> <tr> <th>Kind</th> <th>Value</th> <th>annotation</th> </tr> </thead> <tbody> <tr> <td>maxLength</td> <td>1</td> <td></td> </tr> <tr> <td>pattern</td> <td>[1-9]</td> <td></td> </tr> <tr> <td>enumeration</td> <td>1</td> <td></td> </tr> <tr> <td>enumeration</td> <td>2</td> <td></td> </tr> <tr> <td>enumeration</td> <td>3</td> <td></td> </tr> </tbody> </table>	Kind	Value	annotation	maxLength	1		pattern	[1-9]		enumeration	1		enumeration	2		enumeration	3	
Kind	Value	annotation																	
maxLength	1																		
pattern	[1-9]																		
enumeration	1																		
enumeration	2																		
enumeration	3																		
source	<pre><xs:simpleType name="Numero_RateDa1A3_Type"> <xs:restriction base="cm:DatoN1_Type"> <xs:enumeration value="1"/> <xs:enumeration value="2"/> <xs:enumeration value="3"/> </xs:restriction> </xs:simpleType></pre>																		

simpleType Numero_RateDa2A5_Type

namespace	urn:www.agenziaentrate.gov.it:specificheTecniche:sco:730:v1																					
type	restriction of DatoNP_Type																					
properties	base cm:DatoNP_Type																					
used by	element Misura_Acconti_Type/NumeroRate																					
facets	<table border="1"> <thead> <tr> <th>Kind</th> <th>Value</th> <th>annotation</th> </tr> </thead> <tbody> <tr> <td>length</td> <td>1</td> <td></td> </tr> <tr> <td>pattern</td> <td>[1-9]{1}[0-9]*</td> <td></td> </tr> <tr> <td>enumeration</td> <td>2</td> <td></td> </tr> <tr> <td>enumeration</td> <td>3</td> <td></td> </tr> <tr> <td>enumeration</td> <td>4</td> <td></td> </tr> <tr> <td>enumeration</td> <td>5</td> <td></td> </tr> </tbody> </table>	Kind	Value	annotation	length	1		pattern	[1-9]{1}[0-9]*		enumeration	2		enumeration	3		enumeration	4		enumeration	5	
Kind	Value	annotation																				
length	1																					
pattern	[1-9]{1}[0-9]*																					
enumeration	2																					
enumeration	3																					
enumeration	4																					
enumeration	5																					
source	<pre><xs:simpleType name="Numero_RateDa2A5_Type"> <xs:restriction base="cm:DatoNP_Type"> <xs:length value="1"/> <xs:enumeration value="2"/> <xs:enumeration value="3"/> <xs:enumeration value="4"/> <xs:enumeration value="5"/> </xs:restriction> </xs:simpleType></pre>																					

simpleType Periodo_2006_Type

namespace	urn:www.agenziaentrate.gov.it:specificheTecniche:sco:730:v1						
type	restriction of DatoN1_Type						
properties	base cm:DatoN1_Type						
used by	element Intervento_Ricupero_Patrimonio_Edilizio_Type/Periodo2006						
facets	<table border="1"> <thead> <tr> <th>Kind</th> <th>Value</th> <th>annotation</th> </tr> </thead> <tbody> <tr> <td>maxLength</td> <td>1</td> <td></td> </tr> </tbody> </table>	Kind	Value	annotation	maxLength	1	
Kind	Value	annotation					
maxLength	1						

	pattern [1-9] enumeration 1 enumeration 2
source	<pre> <xs:simpleType name="Periodo_2006_Type"> <xs:restriction base="cm:DatoN1_Type"> <xs:enumeration value="1"/> <xs:enumeration value="2"/> </xs:restriction> </xs:simpleType> </pre>

simpleType Rate10_Type

namespace	urn:www.agenziaentrate.gov.it:specificheTecniche:sco:730:v1																																				
type	restriction of DatoNP_Type																																				
properties	base cm:DatoNP_Type																																				
used by	element N_Rate_Type/Rate10																																				
facets	<table border="1"> <thead> <tr> <th>Kind</th> <th>Value</th> <th>annotation</th> </tr> </thead> <tbody> <tr> <td>pattern</td> <td>[1-9]{1}[0-9]*</td> <td></td> </tr> <tr><td>enumeration</td><td>1</td><td></td></tr> <tr><td>enumeration</td><td>2</td><td></td></tr> <tr><td>enumeration</td><td>3</td><td></td></tr> <tr><td>enumeration</td><td>4</td><td></td></tr> <tr><td>enumeration</td><td>5</td><td></td></tr> <tr><td>enumeration</td><td>6</td><td></td></tr> <tr><td>enumeration</td><td>7</td><td></td></tr> <tr><td>enumeration</td><td>8</td><td></td></tr> <tr><td>enumeration</td><td>9</td><td></td></tr> <tr><td>enumeration</td><td>10</td><td></td></tr> </tbody> </table>	Kind	Value	annotation	pattern	[1-9]{1}[0-9]*		enumeration	1		enumeration	2		enumeration	3		enumeration	4		enumeration	5		enumeration	6		enumeration	7		enumeration	8		enumeration	9		enumeration	10	
Kind	Value	annotation																																			
pattern	[1-9]{1}[0-9]*																																				
enumeration	1																																				
enumeration	2																																				
enumeration	3																																				
enumeration	4																																				
enumeration	5																																				
enumeration	6																																				
enumeration	7																																				
enumeration	8																																				
enumeration	9																																				
enumeration	10																																				
source	<pre> <xs:simpleType name="Rate10_Type"> <xs:restriction base="cm:DatoNP_Type"> <xs:enumeration value="1"/> <xs:enumeration value="2"/> <xs:enumeration value="3"/> <xs:enumeration value="4"/> <xs:enumeration value="5"/> <xs:enumeration value="6"/> <xs:enumeration value="7"/> <xs:enumeration value="8"/> <xs:enumeration value="9"/> <xs:enumeration value="10"/> </xs:restriction> </xs:simpleType> </pre>																																				

simpleType **Rate3_Type**

namespace	urn:www.agenziaentrate.gov.it:specificheTecniche:sco:730:v1															
type	restriction of DatoNP_Type															
properties	base cm:DatoNP_Type															
used by	element N Rate Type/Rate3															
facets	<table><thead><tr><th>Kind</th><th>Value</th><th>annotation</th></tr></thead><tbody><tr><td>pattern</td><td>[1-9]{1}[0-9]*</td><td></td></tr><tr><td>enumeration</td><td>1</td><td></td></tr><tr><td>enumeration</td><td>2</td><td></td></tr><tr><td>enumeration</td><td>3</td><td></td></tr></tbody></table>	Kind	Value	annotation	pattern	[1-9]{1}[0-9]*		enumeration	1		enumeration	2		enumeration	3	
Kind	Value	annotation														
pattern	[1-9]{1}[0-9]*															
enumeration	1															
enumeration	2															
enumeration	3															
source	<pre><xs:simpleType name="Rate3_Type"> <xs:restriction base="cm:DatoNP_Type"> <xs:enumeration value="1"/> <xs:enumeration value="2"/> <xs:enumeration value="3"/> </xs:restriction> </xs:simpleType></pre>															

simpleType **Rate5_Type**

namespace	urn:www.agenziaentrate.gov.it:specificheTecniche:sco:730:v1																					
type	restriction of DatoNP_Type																					
properties	base cm:DatoNP_Type																					
used by	element N Rate Type/Rate5																					
facets	<table><thead><tr><th>Kind</th><th>Value</th><th>annotation</th></tr></thead><tbody><tr><td>pattern</td><td>[1-9]{1}[0-9]*</td><td></td></tr><tr><td>enumeration</td><td>1</td><td></td></tr><tr><td>enumeration</td><td>2</td><td></td></tr><tr><td>enumeration</td><td>3</td><td></td></tr><tr><td>enumeration</td><td>4</td><td></td></tr><tr><td>enumeration</td><td>5</td><td></td></tr></tbody></table>	Kind	Value	annotation	pattern	[1-9]{1}[0-9]*		enumeration	1		enumeration	2		enumeration	3		enumeration	4		enumeration	5	
Kind	Value	annotation																				
pattern	[1-9]{1}[0-9]*																					
enumeration	1																					
enumeration	2																					
enumeration	3																					
enumeration	4																					
enumeration	5																					
source	<pre><xs:simpleType name="Rate5_Type"> <xs:restriction base="cm:DatoNP_Type"> <xs:enumeration value="1"/> <xs:enumeration value="2"/> <xs:enumeration value="3"/> <xs:enumeration value="4"/> <xs:enumeration value="5"/> </xs:restriction> </xs:simpleType></pre>																					

simpleType **Rate_Risparmio_Energetico_Type**

namespace	urn:www.agenziaentrate.gov.it:specificheTecniche:sco:730:v1
-----------	---

type	restriction of DatoNP_Type																														
properties	base cm:DatoNP_Type																														
used by	element Intervento Risparmio Energetico Type/RideterminazioneRate																														
facets	<table border="1"> <thead> <tr> <th>Kind</th> <th>Value</th> <th>annotation</th> </tr> </thead> <tbody> <tr> <td>pattern</td> <td>[1-9]{1}[0-9]*</td> <td></td> </tr> <tr> <td>enumeration</td> <td>3</td> <td></td> </tr> <tr> <td>enumeration</td> <td>4</td> <td></td> </tr> <tr> <td>enumeration</td> <td>5</td> <td></td> </tr> <tr> <td>enumeration</td> <td>6</td> <td></td> </tr> <tr> <td>enumeration</td> <td>7</td> <td></td> </tr> <tr> <td>enumeration</td> <td>8</td> <td></td> </tr> <tr> <td>enumeration</td> <td>9</td> <td></td> </tr> <tr> <td>enumeration</td> <td>10</td> <td></td> </tr> </tbody> </table>	Kind	Value	annotation	pattern	[1-9]{1}[0-9]*		enumeration	3		enumeration	4		enumeration	5		enumeration	6		enumeration	7		enumeration	8		enumeration	9		enumeration	10	
Kind	Value	annotation																													
pattern	[1-9]{1}[0-9]*																														
enumeration	3																														
enumeration	4																														
enumeration	5																														
enumeration	6																														
enumeration	7																														
enumeration	8																														
enumeration	9																														
enumeration	10																														
source	<pre> <xs:simpleType name="Rate_Risparmio_Energetico_Type"> <xs:restriction base="cm:DatoNP_Type"> <xs:enumeration value="3"/> <xs:enumeration value="4"/> <xs:enumeration value="5"/> <xs:enumeration value="6"/> <xs:enumeration value="7"/> <xs:enumeration value="8"/> <xs:enumeration value="9"/> <xs:enumeration value="10"/> </xs:restriction> </xs:simpleType> </pre>																														

simpleType [Reintegro_Totale_Parziale_Type](#)

namespace	urn:www.agenziaentrate.gov.it:specificheTecniche:sco:730:v1															
type	restriction of DatoN1_Type															
properties	base cm:DatoN1_Type															
used by	element Crediti Imposta Fondi Pensione Type/Reintegro															
facets	<table border="1"> <thead> <tr> <th>Kind</th> <th>Value</th> <th>annotation</th> </tr> </thead> <tbody> <tr> <td>maxLength</td> <td>1</td> <td></td> </tr> <tr> <td>pattern</td> <td>[1-9]</td> <td></td> </tr> <tr> <td>enumeration</td> <td>1</td> <td></td> </tr> <tr> <td>enumeration</td> <td>2</td> <td></td> </tr> </tbody> </table>	Kind	Value	annotation	maxLength	1		pattern	[1-9]		enumeration	1		enumeration	2	
Kind	Value	annotation														
maxLength	1															
pattern	[1-9]															
enumeration	1															
enumeration	2															
source	<pre> <xs:simpleType name="Reintegro_Totale_Parziale_Type"> <xs:restriction base="cm:DatoN1_Type"> <xs:enumeration value="1"/> <xs:enumeration value="2"/> </xs:restriction> </xs:simpleType> </pre>															

simpleType Rideterminazione_Rate_Type

namespace	urn:www.agenziaentrate.gov.it:specificheTecniche:sco:730:v1												
type	restriction of DatoNP_Type												
properties	base cm:DatoNP_Type												
used by	element Intervento_Ricupero_Patrimonio_Edilizio_Type/RideterminazioneRate												
facets	<table border="1"> <thead> <tr> <th>Kind</th> <th>Value</th> <th>annotation</th> </tr> </thead> <tbody> <tr> <td>pattern</td> <td>[1-9]{1}[0-9]*</td> <td></td> </tr> <tr> <td>enumeration</td> <td>5</td> <td></td> </tr> <tr> <td>enumeration</td> <td>10</td> <td></td> </tr> </tbody> </table>	Kind	Value	annotation	pattern	[1-9]{1}[0-9]*		enumeration	5		enumeration	10	
Kind	Value	annotation											
pattern	[1-9]{1}[0-9]*												
enumeration	5												
enumeration	10												
source	<pre> <xs:simpleType name="Rideterminazione_Rate_Type"> <xs:restriction base="cm:DatoNP_Type"> <xs:enumeration value="5"/> <xs:enumeration value="10"/> </xs:restriction> </xs:simpleType> </pre>												

simpleType Ripart_Risparmio_Energetico_Type

namespace	urn:www.agenziaentrate.gov.it:specificheTecniche:sco:730:v1																											
type	restriction of DatoNP_Type																											
properties	base cm:DatoNP_Type																											
used by	element Intervento_Risparmio_Energetico_Type/RipartizioneRate																											
facets	<table border="1"> <thead> <tr> <th>Kind</th> <th>Value</th> <th>annotation</th> </tr> </thead> <tbody> <tr> <td>pattern</td> <td>[1-9]{1}[0-9]*</td> <td></td> </tr> <tr> <td>enumeration</td> <td>4</td> <td></td> </tr> <tr> <td>enumeration</td> <td>5</td> <td></td> </tr> <tr> <td>enumeration</td> <td>6</td> <td></td> </tr> <tr> <td>enumeration</td> <td>7</td> <td></td> </tr> <tr> <td>enumeration</td> <td>8</td> <td></td> </tr> <tr> <td>enumeration</td> <td>9</td> <td></td> </tr> <tr> <td>enumeration</td> <td>10</td> <td></td> </tr> </tbody> </table>	Kind	Value	annotation	pattern	[1-9]{1}[0-9]*		enumeration	4		enumeration	5		enumeration	6		enumeration	7		enumeration	8		enumeration	9		enumeration	10	
Kind	Value	annotation																										
pattern	[1-9]{1}[0-9]*																											
enumeration	4																											
enumeration	5																											
enumeration	6																											
enumeration	7																											
enumeration	8																											
enumeration	9																											
enumeration	10																											
source	<pre> <xs:simpleType name="Ripart_Risparmio_Energetico_Type"> <xs:restriction base="cm:DatoNP_Type"> <xs:enumeration value="4"/> <xs:enumeration value="5"/> <xs:enumeration value="6"/> <xs:enumeration value="7"/> <xs:enumeration value="8"/> <xs:enumeration value="9"/> <xs:enumeration value="10"/> </xs:restriction> </xs:simpleType> </pre>																											

simpleType Serie_Registrazione_Contratto_Type

namespace	urn:www.agenziaentrate.gov.it:specificheTecniche:sco:730:v1																					
type	restriction of DatoAN_Type																					
properties	base cm:DatoAN_Type																					
used by	element Dati_Contratto_Type/SerieContratto																					
facets	<table border="1"> <thead> <tr> <th>Kind</th> <th>Value</th> <th>annotation</th> </tr> </thead> <tbody> <tr> <td>pattern</td> <td>[0-9A-Z-]{1}([0-9A-Z] \\- \\. & \\s / ^\\(\\))*</td> <td></td> </tr> <tr> <td>enumeration</td> <td>3</td> <td></td> </tr> <tr> <td>enumeration</td> <td>3A</td> <td></td> </tr> <tr> <td>enumeration</td> <td>3B</td> <td></td> </tr> <tr> <td>enumeration</td> <td>3P</td> <td></td> </tr> <tr> <td>enumeration</td> <td>3T</td> <td></td> </tr> </tbody> </table>	Kind	Value	annotation	pattern	[0-9A-Z-]{1}([0-9A-Z] \\- \\. & \\s / ^\\(\\))*		enumeration	3		enumeration	3A		enumeration	3B		enumeration	3P		enumeration	3T	
Kind	Value	annotation																				
pattern	[0-9A-Z-]{1}([0-9A-Z] \\- \\. & \\s / ^\\(\\))*																					
enumeration	3																					
enumeration	3A																					
enumeration	3B																					
enumeration	3P																					
enumeration	3T																					
source	<pre><xs:simpleType name="Serie_Registrazione_Contratto_Type"> <xs:restriction base="cm:DatoAN_Type"> <xs:enumeration value="3"/> <xs:enumeration value="3A"/> <xs:enumeration value="3B"/> <xs:enumeration value="3P"/> <xs:enumeration value="3T"/> </xs:restriction> </xs:simpleType></pre>																					

simpleType Stato_Civile_Coniuge_Type

namespace	urn:www.agenziaentrate.gov.it:specificheTecniche:sco:730:v1												
type	restriction of DatoNP_Type												
properties	base cm:DatoNP_Type												
used by	element Frontespizio_Con_Type/StatoCivile												
facets	<table border="1"> <thead> <tr> <th>Kind</th> <th>Value</th> <th>annotation</th> </tr> </thead> <tbody> <tr> <td>pattern</td> <td>[1-9]{1}[0-9]*</td> <td></td> </tr> <tr> <td>enumeration</td> <td>2</td> <td></td> </tr> <tr> <td>enumeration</td> <td>4</td> <td></td> </tr> </tbody> </table>	Kind	Value	annotation	pattern	[1-9]{1}[0-9]*		enumeration	2		enumeration	4	
Kind	Value	annotation											
pattern	[1-9]{1}[0-9]*												
enumeration	2												
enumeration	4												
source	<pre><xs:simpleType name="Stato_Civile_Coniuge_Type"> <xs:restriction base="cm:DatoNP_Type"> <xs:enumeration value="2"/> <xs:enumeration value="4"/> </xs:restriction> </xs:simpleType></pre>												

simpleType Stato_Civile_Type

namespace	urn:www.agenziaentrate.gov.it:specificheTecniche:sco:730:v1
type	restriction of DatoNP_Type
properties	base cm:DatoNP_Type

used by	element Frontespizio Dich_Type/StatoCivile																											
facets	<table border="1"> <thead> <tr> <th>Kind</th> <th>Value</th> <th>annotation</th> </tr> </thead> <tbody> <tr> <td>pattern</td> <td>[1-9]{1}[0-9]*</td> <td></td> </tr> <tr> <td>enumeration</td> <td>1</td> <td></td> </tr> <tr> <td>enumeration</td> <td>2</td> <td></td> </tr> <tr> <td>enumeration</td> <td>3</td> <td></td> </tr> <tr> <td>enumeration</td> <td>4</td> <td></td> </tr> <tr> <td>enumeration</td> <td>5</td> <td></td> </tr> <tr> <td>enumeration</td> <td>7</td> <td></td> </tr> <tr> <td>enumeration</td> <td>8</td> <td></td> </tr> </tbody> </table>	Kind	Value	annotation	pattern	[1-9]{1}[0-9]*		enumeration	1		enumeration	2		enumeration	3		enumeration	4		enumeration	5		enumeration	7		enumeration	8	
Kind	Value	annotation																										
pattern	[1-9]{1}[0-9]*																											
enumeration	1																											
enumeration	2																											
enumeration	3																											
enumeration	4																											
enumeration	5																											
enumeration	7																											
enumeration	8																											
source	<pre><xs:simpleType name="Stato_Civile_Type"> <xs:restriction base="cm:DatoNP_Type"> <xs:enumeration value="1"/> <xs:enumeration value="2"/> <xs:enumeration value="3"/> <xs:enumeration value="4"/> <xs:enumeration value="5"/> <xs:enumeration value="7"/> <xs:enumeration value="8"/> </xs:restriction> </xs:simpleType></pre>																											

simpleType Terreni_Urbano_Type

namespace	urn:www.agenziaentrate.gov.it:specificheTecniche:sco:730:v1												
type	restriction of DatoAN_Type												
properties	base cm:DatoAN_Type												
used by	element Dati Catastali Recupero Patrimonio Edilizio_Type/TerreniUrbano												
facets	<table border="1"> <thead> <tr> <th>Kind</th> <th>Value</th> <th>annotation</th> </tr> </thead> <tbody> <tr> <td>pattern</td> <td>[0-9A-Z-]{1}([0-9A-Z] \- \. & _ , \s / ° ^\(\))*</td> <td></td> </tr> <tr> <td>enumeration</td> <td>T</td> <td></td> </tr> <tr> <td>enumeration</td> <td>U</td> <td></td> </tr> </tbody> </table>	Kind	Value	annotation	pattern	[0-9A-Z-]{1}([0-9A-Z] \- \. & _ , \s / ° ^\(\))*		enumeration	T		enumeration	U	
Kind	Value	annotation											
pattern	[0-9A-Z-]{1}([0-9A-Z] \- \. & _ , \s / ° ^\(\))*												
enumeration	T												
enumeration	U												
source	<pre><xs:simpleType name="Terreni_Urbano_Type"> <xs:restriction base="cm:DatoAN_Type"> <xs:enumeration value="T"/> <xs:enumeration value="U"/> </xs:restriction> </xs:simpleType></pre>												

simpleType Tipo_Fornitore_730_Type

namespace	urn:www.agenziaentrate.gov.it:specificheTecniche:sco:730:v1
type	restriction of DatoNP_Type
properties	base cm:DatoNP_Type

used by	element Intestazione_730_Type/TipoFornitore																					
facets	<table border="1"> <thead> <tr> <th>Kind</th> <th>Value</th> <th>annotation</th> </tr> </thead> <tbody> <tr> <td>pattern</td> <td>[1-9]{1}[0-9]*</td> <td></td> </tr> <tr> <td>enumeration</td> <td>1</td> <td></td> </tr> <tr> <td>enumeration</td> <td>3</td> <td></td> </tr> <tr> <td>enumeration</td> <td>5</td> <td></td> </tr> <tr> <td>enumeration</td> <td>6</td> <td></td> </tr> <tr> <td>enumeration</td> <td>10</td> <td></td> </tr> </tbody> </table>	Kind	Value	annotation	pattern	[1-9]{1}[0-9]*		enumeration	1		enumeration	3		enumeration	5		enumeration	6		enumeration	10	
Kind	Value	annotation																				
pattern	[1-9]{1}[0-9]*																					
enumeration	1																					
enumeration	3																					
enumeration	5																					
enumeration	6																					
enumeration	10																					
source	<pre><xs:simpleType name="Tipo_Fornitore_730_Type"> <xs:restriction base="cm:DatoNP_Type"> <xs:enumeration value="1"/> <xs:enumeration value="3"/> <xs:enumeration value="5"/> <xs:enumeration value="6"/> <xs:enumeration value="10"/> </xs:restriction> </xs:simpleType></pre>																					

simpleType [Tipo_Inquilino_Type](#)

namespace	urn:www.agenziaentrate.gov.it:specificheTecniche:sco:730:v1															
type	restriction of DatoNP_Type															
properties	base cm:DatoNP_Type															
used by	element Inquilini_Abitazione_Principale_Type/Tipologia															
facets	<table border="1"> <thead> <tr> <th>Kind</th> <th>Value</th> <th>annotation</th> </tr> </thead> <tbody> <tr> <td>pattern</td> <td>[1-9]{1}[0-9]*</td> <td></td> </tr> <tr> <td>enumeration</td> <td>1</td> <td></td> </tr> <tr> <td>enumeration</td> <td>2</td> <td></td> </tr> <tr> <td>enumeration</td> <td>3</td> <td></td> </tr> </tbody> </table>	Kind	Value	annotation	pattern	[1-9]{1}[0-9]*		enumeration	1		enumeration	2		enumeration	3	
Kind	Value	annotation														
pattern	[1-9]{1}[0-9]*															
enumeration	1															
enumeration	2															
enumeration	3															
source	<pre><xs:simpleType name="Tipo_Inquilino_Type"> <xs:restriction base="cm:DatoNP_Type"> <xs:enumeration value="1"/> <xs:enumeration value="2"/> <xs:enumeration value="3"/> </xs:restriction> </xs:simpleType></pre>															

simpleType [Tipo_Intervento_Type](#)

namespace	urn:www.agenziaentrate.gov.it:specificheTecniche:sco:730:v1						
type	restriction of DatoN1_Type						
properties	base cm:DatoN1_Type						
used by	element Intervento_Risparmio_Energetico_Type/TipolIntervento						
facets	<table border="1"> <thead> <tr> <th>Kind</th> <th>Value</th> <th>annotation</th> </tr> </thead> <tbody> <tr> <td>maxLength</td> <td>1</td> <td></td> </tr> </tbody> </table>	Kind	Value	annotation	maxLength	1	
Kind	Value	annotation					
maxLength	1						

	pattern [1-9] enumeration 1 enumeration 2 enumeration 3 enumeration 4
source	<pre> <xs:simpleType name="Tipo_Intervento_Type"> <xs:restriction base="cm:DatoN1_Type"> <xs:enumeration value="1"/> <xs:enumeration value="2"/> <xs:enumeration value="3"/> <xs:enumeration value="4"/> </xs:restriction> </xs:simpleType> </pre>

simpleType Tipo_Reddito_Da1a12_Type

namespace	urn:www.agenziaentrate.gov.it:specificheTecniche:sco:730:v1		
type	restriction of DatoNP_Type		
properties	base	cm:DatoNP_Type	
used by	element	Redditi Eredi Legatari Type/TipoReddito	
facets	Kind	Value	annotation
	maxLength	2	
	pattern	[1-9]{1}[0-9]*	
	enumeration	1	
	enumeration	2	
	enumeration	3	
	enumeration	4	
	enumeration	5	
	enumeration	6	
	enumeration	7	
	enumeration	8	
	enumeration	9	
	enumeration	10	
	enumeration	11	
	enumeration	12	
source	<pre> <xs:simpleType name="Tipo_Reddito_Da1a12_Type"> <xs:restriction base="cm:DatoNP_Type"> <xs:maxLength value="2"/> <xs:enumeration value="1"/> <xs:enumeration value="2"/> <xs:enumeration value="3"/> <xs:enumeration value="4"/> <xs:enumeration value="5"/> <xs:enumeration value="6"/> <xs:enumeration value="7"/> <xs:enumeration value="8"/> </xs:restriction> </xs:simpleType> </pre>		

	<pre> <xs:enumeration value="9"/> <xs:enumeration value="10"/> <xs:enumeration value="11"/> <xs:enumeration value="12"/> </xs:restriction> </xs:simpleType> </pre>
--	--

simpleType **Tipo_Reddito_Da1a3_Type**

namespace	urn:www.agenziaentrate.gov.it:specificheTecniche:sco:730:v1																		
type	restriction of DatoN1_Type																		
properties	base cm:DatoN1_Type																		
used by	elements Altri Redditi Diversi Detr Type/Tipo Reddito Lavoro Dipendente Type/TipologiaReddito Altri Redditi Lavoro Autonomo Type/TipoReddito																		
facets	<table border="1"> <thead> <tr> <th>Kind</th> <th>Value</th> <th>annotation</th> </tr> </thead> <tbody> <tr> <td>maxLength</td> <td>1</td> <td></td> </tr> <tr> <td>pattern</td> <td>[1-9]</td> <td></td> </tr> <tr> <td>enumeration</td> <td>1</td> <td></td> </tr> <tr> <td>enumeration</td> <td>2</td> <td></td> </tr> <tr> <td>enumeration</td> <td>3</td> <td></td> </tr> </tbody> </table>	Kind	Value	annotation	maxLength	1		pattern	[1-9]		enumeration	1		enumeration	2		enumeration	3	
Kind	Value	annotation																	
maxLength	1																		
pattern	[1-9]																		
enumeration	1																		
enumeration	2																		
enumeration	3																		
source	<pre> <xs:simpleType name="Tipo_Reddito_Da1a3_Type"> <xs:restriction base="cm:DatoN1_Type"> <xs:enumeration value="1"/> <xs:enumeration value="2"/> <xs:enumeration value="3"/> </xs:restriction> </xs:simpleType> </pre>																		

simpleType **Tipo_Reddito_Da1a6_Type**

namespace	urn:www.agenziaentrate.gov.it:specificheTecniche:sco:730:v1																											
type	restriction of DatoN1_Type																											
properties	final <empty> base cm:DatoN1_Type																											
used by	element Altri Redditi Utili Type/Tipo Reddito																											
facets	<table border="1"> <thead> <tr> <th>Kind</th> <th>Value</th> <th>annotation</th> </tr> </thead> <tbody> <tr> <td>maxLength</td> <td>1</td> <td></td> </tr> <tr> <td>pattern</td> <td>[1-9]</td> <td></td> </tr> <tr> <td>enumeration</td> <td>1</td> <td></td> </tr> <tr> <td>enumeration</td> <td>2</td> <td></td> </tr> <tr> <td>enumeration</td> <td>3</td> <td></td> </tr> <tr> <td>enumeration</td> <td>4</td> <td></td> </tr> <tr> <td>enumeration</td> <td>5</td> <td></td> </tr> <tr> <td>enumeration</td> <td>6</td> <td></td> </tr> </tbody> </table>	Kind	Value	annotation	maxLength	1		pattern	[1-9]		enumeration	1		enumeration	2		enumeration	3		enumeration	4		enumeration	5		enumeration	6	
Kind	Value	annotation																										
maxLength	1																											
pattern	[1-9]																											
enumeration	1																											
enumeration	2																											
enumeration	3																											
enumeration	4																											
enumeration	5																											
enumeration	6																											
source	<pre> <xs:simpleType name="Tipo_Reddito_Da1a6_Type" final=""> <xs:restriction base="cm:DatoN1_Type"> </pre>																											

	<pre> <xs:enumeration value="1"/> <xs:enumeration value="2"/> <xs:enumeration value="3"/> <xs:enumeration value="4"/> <xs:enumeration value="5"/> <xs:enumeration value="6"/> </xs:restriction> </xs:simpleType> </pre>
--	---

simpleType **Tipo_Reddito_Da1a7_Type**

namespace	urn:www.agenziaentrate.gov.it:specificheTecniche:sco:730:v1																														
type	restriction of DatoN1_Type																														
properties	base cm:DatoN1_Type																														
used by	element Altri_Redditi_Diversi_Type/TipoReddito																														
facets	<table border="1"> <thead> <tr> <th>Kind</th> <th>Value</th> <th>annotation</th> </tr> </thead> <tbody> <tr> <td>maxLength</td> <td>1</td> <td></td> </tr> <tr> <td>pattern</td> <td>[1-9]</td> <td></td> </tr> <tr> <td>enumeration</td> <td>1</td> <td></td> </tr> <tr> <td>enumeration</td> <td>2</td> <td></td> </tr> <tr> <td>enumeration</td> <td>3</td> <td></td> </tr> <tr> <td>enumeration</td> <td>4</td> <td></td> </tr> <tr> <td>enumeration</td> <td>5</td> <td></td> </tr> <tr> <td>enumeration</td> <td>6</td> <td></td> </tr> <tr> <td>enumeration</td> <td>7</td> <td></td> </tr> </tbody> </table>	Kind	Value	annotation	maxLength	1		pattern	[1-9]		enumeration	1		enumeration	2		enumeration	3		enumeration	4		enumeration	5		enumeration	6		enumeration	7	
Kind	Value	annotation																													
maxLength	1																														
pattern	[1-9]																														
enumeration	1																														
enumeration	2																														
enumeration	3																														
enumeration	4																														
enumeration	5																														
enumeration	6																														
enumeration	7																														
source	<pre> <xs:simpleType name="Tipo_Reddito_Da1a7_Type"> <xs:restriction base="cm:DatoN1_Type"> <xs:enumeration value="1"/> <xs:enumeration value="2"/> <xs:enumeration value="3"/> <xs:enumeration value="4"/> <xs:enumeration value="5"/> <xs:enumeration value="6"/> <xs:enumeration value="7"/> </xs:restriction> </xs:simpleType> </pre>																														

simpleType **Tipo_Reddito_Da1a8_Type**

namespace	urn:www.agenziaentrate.gov.it:specificheTecniche:sco:730:v1						
type	restriction of DatoNP_Type						
properties	base cm:DatoNP_Type						
used by	elements Sezione_Altri_Redd_Type/TipoReddito Imposte Rimborsate_Type/TipoReddito						
facets	<table border="1"> <thead> <tr> <th>Kind</th> <th>Value</th> <th>annotation</th> </tr> </thead> <tbody> <tr> <td>maxLength</td> <td>2</td> <td></td> </tr> </tbody> </table>	Kind	Value	annotation	maxLength	2	
Kind	Value	annotation					
maxLength	2						

	<p>pattern [1-9]{1}[0-9]*</p> <p>enumeration 1</p> <p>enumeration 2</p> <p>enumeration 3</p> <p>enumeration 4</p> <p>enumeration 5</p> <p>enumeration 6</p> <p>enumeration 7</p> <p>enumeration 8</p>
source	<pre><xs:simpleType name="Tipo_Reddito_Dala8_Type"> <xs:restriction base="cm:DatoNP_Type"> <xs:maxLength value="2"/> <xs:enumeration value="1"/> <xs:enumeration value="2"/> <xs:enumeration value="3"/> <xs:enumeration value="4"/> <xs:enumeration value="5"/> <xs:enumeration value="6"/> <xs:enumeration value="7"/> <xs:enumeration value="8"/> </xs:restriction> </xs:simpleType></pre>

simpleType **Tipologia_Soggetto_AssFisc_Type**

namespace	urn:www.agenziaentrate.gov.it:specificheTecniche:sco:730:v1																					
type	restriction of DatoN1_Type																					
properties	base cm:DatoN1_Type																					
used by	element Soggetto_Assistenza_FiscaliDoc_type/TipologiaSoggettoAssFisc																					
facets	<table border="1"> <thead> <tr> <th>Kind</th> <th>Value</th> <th>annotation</th> </tr> </thead> <tbody> <tr> <td>maxLength</td> <td>1</td> <td></td> </tr> <tr> <td>pattern</td> <td>[1-9]</td> <td></td> </tr> <tr> <td>enumeration</td> <td>1</td> <td></td> </tr> <tr> <td>enumeration</td> <td>2</td> <td></td> </tr> <tr> <td>enumeration</td> <td>3</td> <td></td> </tr> <tr> <td>enumeration</td> <td>4</td> <td></td> </tr> </tbody> </table>	Kind	Value	annotation	maxLength	1		pattern	[1-9]		enumeration	1		enumeration	2		enumeration	3		enumeration	4	
Kind	Value	annotation																				
maxLength	1																					
pattern	[1-9]																					
enumeration	1																					
enumeration	2																					
enumeration	3																					
enumeration	4																					
source	<pre><xs:simpleType name="Tipologia_Soggetto_AssFisc_Type"> <xs:restriction base="cm:DatoN1_Type"> <xs:enumeration value="1"/> <xs:enumeration value="2"/> <xs:enumeration value="3"/> <xs:enumeration value="4"/> </xs:restriction> </xs:simpleType></pre>																					

simpleType TitoloTerreno_Type

namespace	urn:www.agenziaentrate.gov.it:specificheTecniche:sco:730:v1																														
type	restriction of DatoN1_Type																														
properties	base cm:DatoN1_Type																														
used by	element Terreno_Type/Titolo																														
facets	<table border="1"> <thead> <tr> <th>Kind</th> <th>Value</th> <th>annotation</th> </tr> </thead> <tbody> <tr> <td>maxLength</td> <td>1</td> <td></td> </tr> <tr> <td>pattern</td> <td>[1-9]</td> <td></td> </tr> <tr> <td>enumeration</td> <td>1</td> <td></td> </tr> <tr> <td>enumeration</td> <td>2</td> <td></td> </tr> <tr> <td>enumeration</td> <td>3</td> <td></td> </tr> <tr> <td>enumeration</td> <td>4</td> <td></td> </tr> <tr> <td>enumeration</td> <td>5</td> <td></td> </tr> <tr> <td>enumeration</td> <td>6</td> <td></td> </tr> <tr> <td>enumeration</td> <td>7</td> <td></td> </tr> </tbody> </table>	Kind	Value	annotation	maxLength	1		pattern	[1-9]		enumeration	1		enumeration	2		enumeration	3		enumeration	4		enumeration	5		enumeration	6		enumeration	7	
Kind	Value	annotation																													
maxLength	1																														
pattern	[1-9]																														
enumeration	1																														
enumeration	2																														
enumeration	3																														
enumeration	4																														
enumeration	5																														
enumeration	6																														
enumeration	7																														
source	<pre> <xs:simpleType name="TitoloTerreno_Type"> <xs:restriction base="cm:DatoN1_Type"> <xs:enumeration value="1"/> <xs:enumeration value="2"/> <xs:enumeration value="3"/> <xs:enumeration value="4"/> <xs:enumeration value="5"/> <xs:enumeration value="6"/> <xs:enumeration value="7"/> </xs:restriction> </xs:simpleType> </pre>																														

simpleType Utilizzo_Fabbricato_Type

namespace	urn:www.agenziaentrate.gov.it:specificheTecniche:sco:730:v1																																	
type	restriction of DatoNP_Type																																	
properties	base cm:DatoNP_Type																																	
used by	element FabbricatoOrd_Type/Utilizzo																																	
facets	<table border="1"> <thead> <tr> <th>Kind</th> <th>Value</th> <th>annotation</th> </tr> </thead> <tbody> <tr> <td>minLength</td> <td>1</td> <td></td> </tr> <tr> <td>maxLength</td> <td>2</td> <td></td> </tr> <tr> <td>pattern</td> <td>[1-9]{1}[0-9]*</td> <td></td> </tr> <tr> <td>enumeration</td> <td>1</td> <td></td> </tr> <tr> <td>enumeration</td> <td>2</td> <td></td> </tr> <tr> <td>enumeration</td> <td>3</td> <td></td> </tr> <tr> <td>enumeration</td> <td>4</td> <td></td> </tr> <tr> <td>enumeration</td> <td>5</td> <td></td> </tr> <tr> <td>enumeration</td> <td>7</td> <td></td> </tr> <tr> <td>enumeration</td> <td>8</td> <td></td> </tr> </tbody> </table>	Kind	Value	annotation	minLength	1		maxLength	2		pattern	[1-9]{1}[0-9]*		enumeration	1		enumeration	2		enumeration	3		enumeration	4		enumeration	5		enumeration	7		enumeration	8	
Kind	Value	annotation																																
minLength	1																																	
maxLength	2																																	
pattern	[1-9]{1}[0-9]*																																	
enumeration	1																																	
enumeration	2																																	
enumeration	3																																	
enumeration	4																																	
enumeration	5																																	
enumeration	7																																	
enumeration	8																																	

	enumeration 9 enumeration 10 enumeration 11 enumeration 12 enumeration 13 enumeration 14 enumeration 15 enumeration 16
source	<pre> <xs:simpleType name="Utilizzo_Fabbricato_Type"> <xs:restriction base="cm:DatoNP_Type"> <xs:minLength value="1"/> <xs:maxLength value="2"/> <xs:enumeration value="1"/> <xs:enumeration value="2"/> <xs:enumeration value="3"/> <xs:enumeration value="4"/> <xs:enumeration value="5"/> <xs:enumeration value="7"/> <xs:enumeration value="8"/> <xs:enumeration value="9"/> <xs:enumeration value="10"/> <xs:enumeration value="11"/> <xs:enumeration value="12"/> <xs:enumeration value="13"/> <xs:enumeration value="14"/> <xs:enumeration value="15"/> <xs:enumeration value="16"/> </xs:restriction> </xs:simpleType> </pre>

element **Documento**

diagram						
namespace	urn:www.agenziaentrate.gov.it:specificheTecniche:common:v2					
type	Documento_Type					
properties	content	complex				
	abstract	true				
used by	element	Fornitura				
attributes	Name	Type	Use	Default	Fixed	annotation
	identificativo	Identificativo_Type	required			

source	<code><xs:element name="Documento" type="Documento_Type" abstract="true"/></code>
--------	---

element Fornitura

diagram	
namespace	urn:www.agenziaentrate.gov.it:specificheTecniche:common:v2
properties	content complex
children	Intestazione Documento
source	<pre> <xs:element name="Fornitura"> <xs:complexType> <xs:sequence> <xs:element name="Intestazione" type="Intestazione_Type"/> <xs:element ref="Documento" maxOccurs="unbounded"/> </xs:sequence> </xs:complexType> </xs:element> </pre>

element Fornitura/Intestazione

diagram	
namespace	urn:www.agenziaentrate.gov.it:specificheTecniche:common:v2
type	Intestazione_Type
properties	isRef 0 content complex
children	CodiceFiscaleFornitore SpazioUtente SpazioServizioTelematico CodiceFornitura TipoFornitore
source	<code><xs:element name="Intestazione" type="Intestazione_Type"/></code>

complexType Dati_Intestazione_Type

diagram	
namespace	urn:www.agenziaentrate.gov.it:specificheTecniche:common:v2
children	CodiceFiscaleFornitore SpazioUtente SpazioServizioTelematico
used by	element Fornitura/Intestazione complexTypes Intestazione 730 Type Intestazione Type
source	<pre> <xs:complexType name="Dati_Intestazione_Type"> <xs:sequence> <xs:element name="CodiceFiscaleFornitore" type="DatoCF_Type"/> <xs:element name="SpazioUtente" type="DatoAN_Type" minOccurs="0"/> <xs:element name="SpazioServizioTelematico" type="DatoAN_Type" minOccurs="0"/> </xs:sequence> </xs:complexType> </pre>

element Dati_Intestazione_Type/CodiceFiscaleFornitore

diagram	
namespace	urn:www.agenziaentrate.gov.it:specificheTecniche:common:v2
type	DatoCF_Type
properties	isRef 0 content simple
facets	Kind Value pattern [0-9]{11}[A-Z]{6}[0-9LMNPQRSTUUV]{2}[A-Z]{1}[0-9LMNPQRSTUUV]{2}[A-Z]{1}[0-9LMNPQRSTUUV]{3}[A-Z]{1} annotation
source	<pre> <xs:element name="CodiceFiscaleFornitore" type="DatoCF_Type"/> </pre>

element Dati_Intestazione_Type/SpazioUtente

diagram	
namespace	urn:www.agenziaentrate.gov.it:specificheTecniche:common:v2
type	DatoAN_Type
properties	isRef 0 minOcc 0 maxOcc 1 content simple

facets	Kind Value annotation pattern [0-9A-Z-]{1}([0-9A-Z] \. \& , s / \^\ \)*
source	<code><xs:element name="SpazioUtente" type="DatoAN_Type" minOccurs="0"/></code>

element Dati_Intestazione_Type/SpazioServizioTelematico

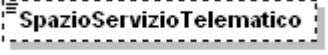
diagram	
namespace	urn:www.agenziaentrate.gov.it:specificheTecniche:common:v2
type	DatoAN_Type
properties	isRef 0 minOcc 0 maxOcc 1 content simple
facets	Kind Value annotation pattern [0-9A-Z-]{1}([0-9A-Z] \. \& , s / \^\ \)*
source	<code><xs:element name="SpazioServizioTelematico" type="DatoAN_Type" minOccurs="0"/></code>

complexType Documento_Type

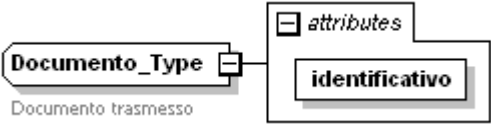
diagram	
namespace	urn:www.agenziaentrate.gov.it:specificheTecniche:common:v2
used by	element Documento complexType Documento_730_Type Documento_SCE_Type
attributes	Name Type Use Default Fixed annotation identificativo Identificativo_Type required
annotation	documentation Documento trasmesso
source	<code><xs:complexType name="Documento_Type"> <xs:annotation> <xs:documentation xml:lang="it">Documento trasmesso</xs:documentation> </xs:annotation> <xs:attribute name="identificativo" type="Identificativo_Type" use="required"/> </xs:complexType></code>

attribute Documento_Type/@identificativo

type	Identificativo_Type
properties	isRef 0 use required

facets	Kind Value pattern [0-9]{4}[1-9][0-9]{3}[1-9][0-9][0-9]{2}[1-9][0-9]{2}[0-9][1-9][0-9]{3}[1-9][0-9]{4}	annotation
source	<code><xs:attribute name="identificativo" type="Identificativo_Type" use="required"/></code>	

complexType Intestazione_Type

diagram		
namespace	urn:www.agenziaentrate.gov.it:specificheTecniche:common:v2	
type	extension of Dati Intestazione_Type	
properties	base Dati_Intestazione_Type	
children	CodiceFiscaleFornitore SpazioUtente SpazioServizioTelematico CodiceFornitura TipoFornitore	
used by	element Fornitura/Intestazione	
annotation	documentation Dati generali della fornitura	
source	<pre> <xs:complexType name="Intestazione_Type"> <xs:annotation> <xs:documentation xml:lang="it">Dati generali della fornitura</xs:documentation> </xs:annotation> <xs:complexContent> <xs:extension base="Dati_Intestazione_Type"> <xs:sequence> <xs:element name="CodiceFornitura" type="CodiceFornitura_Type"/> <xs:element name="TipoFornitore" type="DatoNP_Type"/> </xs:sequence> </xs:extension> </xs:complexContent> </xs:complexType> </pre>	

element **Intestazione_Type/CodiceFornitura**

diagram	
namespace	urn:www.agenziaentrate.gov.it:specificheTecniche:common:v2
type	CodiceFornitura_Type
properties	isRef 0 content simple
facets	Kind Value annotation length 5 pattern [0-9A-Z-]{1}([0-9A-Z] \\- \\. & \\s / ° \\^ \\(\\))*
source	<pre><xs:element name="CodiceFornitura" type="CodiceFornitura_Type"/></pre>

element **Intestazione_Type/TipoFornitore**

diagram	
namespace	urn:www.agenziaentrate.gov.it:specificheTecniche:common:v2
type	DatoNP_Type
properties	isRef 0 content simple
facets	Kind Value annotation pattern [1-9]{1}[0-9]*
source	<pre><xs:element name="TipoFornitore" type="DatoNP_Type"/></pre>

simpleType **CodiceFornitura_Type**

namespace	urn:www.agenziaentrate.gov.it:specificheTecniche:common:v2
type	restriction of DatoAN_Type
properties	base DatoAN_Type
used by	elements Intestazione_Type/CodiceFornitura Intestazione_730_Type/CodiceFornitura Fornitura/Intestazione/CodiceFornitura Intestazione_SCE_Type/CodiceFornitura
facets	Kind Value annotation length 5 pattern [0-9A-Z-]{1}([0-9A-Z] \\- \\. & \\s / ° \\^ \\(\\))*
source	<pre><xs:simpleType name="CodiceFornitura_Type"> <xs:restriction base="DatoAN_Type"> <xs:length value="5"/> </xs:restriction> </xs:simpleType></pre>

simpleType **Identificativo_Type**

namespace	urn:www.agenziaentrate.gov.it:specificheTecniche:common:v2
type	restriction of xs:string

properties	base <code>xs:string</code>
used by	attribute Documento_Type/@identificativo
facets	Kind Value annotation pattern <code>[0-9]{4}[1-9] [0-9]{3}[1-9][0-9] [0-9]{2}[1-9][0-9]{2} [0-9][1-9][0-9]{3} [1-9][0-9]{4}</code>
source	<pre><xs:simpleType name="Identificativo_Type"> <xs:restriction base="xs:string"> <xs:pattern value="[0-9]{4}[1-9] [0-9]{3}[1-9][0-9] [0-9]{2}[1-9][0-9]{2} [0-9][1-9][0-9]{3} [1-9][0-9]{4}" /> </xs:restriction> </xs:simpleType></pre>

complexType **Dati_Anagrafici_Type**

diagram	
namespace	urn:www.agenziaentrate.gov.it:specificheTecniche:sco:common:v2
children	Cognome Nome Sesso DataNascita ComuneNascita ProvinciaNascita
used by	elements Persone Fisiche_Type/DatiAnagrafici Dati Sottoscrittore_Type/DatiAnagrafici Frontespizio 730_Type/DatiAnagrafici Frontespizio Dich_Type/Rappresentante/DatiAnagrafici Documento 730-4/DatiAnagraficiDichiarante
source	<pre><xs:complexType name="Dati_Anagrafici_Type"> <xs:sequence> <xs:element name="Cognome" type="cm:DatoAN_Type"/> <xs:element name="Nome" type="cm:DatoAN_Type"/> <xs:element name="Sesso" type="Sesso_Type"/> <xs:element name="DataNascita" type="cm:DatoDT_Type"/> <xs:element name="ComuneNascita" type="cm:DatoAN_Type"/> <xs:element name="ProvinciaNascita" type="cm:PN_Type" minOccurs="0"/> </xs:sequence> </xs:complexType></pre>

element Dati_Anagrafici_Type/Cognome

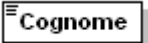
diagram	
namespace	urn:www.agenziaentrate.gov.it:specificheTecniche:sco:common:v2
type	DatoAN_Type
properties	isRef 0 content simple
facets	Kind Value annotation pattern [0-9A-Z-]{1}([0-9A-Z] [-\.\& , s / ° ^\(\))]*
source	<code><xs:element name="Cognome" type="cm:DatoAN_Type"/></code>

element Dati_Anagrafici_Type/Nome

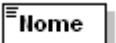
diagram	
namespace	urn:www.agenziaentrate.gov.it:specificheTecniche:sco:common:v2
type	DatoAN_Type
properties	isRef 0 content simple
facets	Kind Value annotation pattern [0-9A-Z-]{1}([0-9A-Z] [-\.\& , s / ° ^\(\))]*
source	<code><xs:element name="Nome" type="cm:DatoAN_Type"/></code>

element Dati_Anagrafici_Type/Sesso

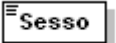
diagram	
namespace	urn:www.agenziaentrate.gov.it:specificheTecniche:sco:common:v2
type	Sesso_Type
properties	isRef 0 content simple
facets	Kind Value annotation pattern [0-9A-Z-]{1}([0-9A-Z] [-\.\& , s / ° ^\(\))]* enumeration M documentation <![CDATA[Maschio]]> enumeration F documentation <![CDATA[Femmina]]>
source	<code><xs:element name="Sesso" type="Sesso_Type"/></code>

element Dati_Anagrafici_Type/DataNascita

diagram	
namespace	urn:www.agenziaentrate.gov.it:specificheTecniche:sco:common:v2
type	DatoDT_Type

properties	isRef 0 content simple
facets	Kind Value length 8 pattern ((([0-9][12][0-9]3[01])([013578]10 12)(\d{4})) ([0][1-9][12][0-9]30)([0469]11)(\d{4})) ([01-9]1[0-9]2[0-8])(02)(\d{4})) ((29)(02)([02468][048]00)) ((29)(02)([13579][26]00)) ((29)(02)([0-9][0-9][0][48])) ((29)(02)([0-9][0-9][2468][048])) ((29)(02)([0-9][0-9][13579][26]))
source	<xs:element name="DataNascita" type="cm:DatoDT_Type"/>

element Dati_Anagrafici_Type/ComuneNascita

diagram	
namespace	urn:www.agenziaentrate.gov.it:specificheTecniche:sco:common:v2
type	DatoAN_Type
properties	isRef 0 content simple
facets	Kind Value pattern [0-9A-Z-]{1}([0-9A-Z] \- \. & _ \\s / ° \\^ \\)* annotation
source	<xs:element name="ComuneNascita" type="cm:DatoAN_Type"/>

element Dati_Anagrafici_Type/ProvinciaNascita

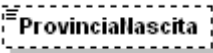
diagram	
namespace	urn:www.agenziaentrate.gov.it:specificheTecniche:sco:common:v2
type	PN_Type
properties	isRef 0 minOcc 0 maxOcc 1 content simple
source	<xs:element name="ProvinciaNascita" type="cm:PN_Type" minOccurs="0"/>

complexType Dati_Sottoscrittore_Type

<p>diagram</p>	
<p>namespace</p>	<p>urn:www.agenziaentrate.gov.it:specificheTecniche:sco:common:v2</p>
<p>children</p>	<p>CodiceFiscale CodiceCarica CodiceFiscaleSocieta DatiAnagrafici ResidenzaEstera Telefono DataCarica InizioProcedura ProceduraNonTerminata FineProcedura</p>
<p>source</p>	<pre><xs:complexType name="Dati_Sottoscrittore_Type"> <xs:sequence> <xs:element name="CodiceFiscale" type="cm:DatoCF_Type"/> <xs:element name="CodiceCarica" type="Codice_Carica_Type"/> <xs:element name="CodiceFiscaleSocieta" type="cm:DatoCN_Type" minOccurs="0"/> <xs:element name="DatiAnagrafici" type="Dati_Anagrafici_Type"/> <xs:element name="ResidenzaEstera" type="Residenza_Estera_Type" minOccurs="0"/> <xs:element name="Telefono" type="cm:DatoTL_Type" minOccurs="0"/> <xs:element name="DataCarica" type="cm:DatoDT_Type" minOccurs="0"/> <xs:element name="InizioProcedura" type="cm:DatoDT_Type" minOccurs="0"/> <xs:element name="ProceduraNonTerminata" type="cm:DatoCB_Type" minOccurs="0"/> <xs:element name="FineProcedura" type="cm:DatoDT_Type" minOccurs="0"/> </xs:sequence> </xs:complexType></pre>

element Dati_Sottoscrittore_Type/CodiceFiscale

diagram	
namespace	urn:www.agenziaentrate.gov.it:specificheTecniche:sco:common:v2
type	DatoCF_Type
properties	isRef 0 content simple
facets	Kind Value annotation pattern [0-9]{11}[A-Z]{6}[0-9LMNPQRSTU]{2}[A-Z]{1}[0-9LMNPQRSTU]{2}[A-Z]{1}[0-9LMNPQRSTU]{3}[A-Z]{1}
source	<xs:element name="CodiceFiscale" type="cm:DatoCF_Type"/>

element Dati_Sottoscrittore_Type/CodiceCarica

diagram																																																	
namespace	urn:www.agenziaentrate.gov.it:specificheTecniche:sco:common:v2																																																
type	Codice_Carica_Type																																																
properties	isRef 0 content simple																																																
facets	<table border="0"> <thead> <tr> <th>Kind</th> <th>Value</th> <th>annotation</th> </tr> </thead> <tbody> <tr> <td>pattern</td> <td>[1-9]{1}[0-9]*</td> <td></td> </tr> <tr> <td>enumeration</td> <td>1</td> <td>documentation Rappresentante legale, negoziale o di fatto, socio amministratore</td> </tr> <tr> <td>enumeration</td> <td>2</td> <td>documentation <![CDATA[Rappresentante di minore, inabilitato o interdetto, amministratore di sostegno, ovvero curatore dell'eredità giacente, amministratore dell'eredità]]></td> </tr> <tr> <td>enumeration</td> <td>3</td> <td>documentation Curatore fallimentare</td> </tr> <tr> <td>enumeration</td> <td>4</td> <td>documentation Commissario liquidatore</td> </tr> <tr> <td>enumeration</td> <td>5</td> <td>documentation Commissario giudiziale</td> </tr> <tr> <td>enumeration</td> <td>6</td> <td>documentation <![CDATA[Rappresentante fiscale di soggetto non residente]]></td> </tr> <tr> <td>enumeration</td> <td>7</td> <td>documentation Erede</td> </tr> <tr> <td>enumeration</td> <td>8</td> <td>documentation <![CDATA[Liquidatore - liquidazione volontaria]]></td> </tr> <tr> <td>enumeration</td> <td>9</td> <td>documentation <![CDATA[Soggetto tenuto a presentare dichiarazione in caso di operazioni straordinarie]]></td> </tr> <tr> <td>enumeration</td> <td>10</td> <td>documentation <![CDATA[Rappresentante fiscale di soggetto non residente con le limitazioni di cui all'art. 44, comma 3, del D.L. n.331/1993]]></td> </tr> <tr> <td>enumeration</td> <td>11</td> <td>documentation <![CDATA[Soggetto esercente l'attività tutoria del minore o interdetto in relazione alla funzione istituzionale rivestita]]></td> </tr> <tr> <td>enumeration</td> <td>12</td> <td>documentation <![CDATA[Liquidatore - liquidazione volontaria di ditta individuale periodo ante messa in liquidazione]]></td> </tr> <tr> <td>enumeration</td> <td>13</td> <td>documentation Amministratore di condominio</td> </tr> <tr> <td>enumeration</td> <td>14</td> <td>documentation <![CDATA[Soggetto che sottoscrive la dichiarazione per conto di una pubblica amministrazione]]></td> </tr> </tbody> </table>	Kind	Value	annotation	pattern	[1-9]{1}[0-9]*		enumeration	1	documentation Rappresentante legale, negoziale o di fatto, socio amministratore	enumeration	2	documentation <![CDATA[Rappresentante di minore, inabilitato o interdetto, amministratore di sostegno, ovvero curatore dell'eredità giacente, amministratore dell'eredità]]>	enumeration	3	documentation Curatore fallimentare	enumeration	4	documentation Commissario liquidatore	enumeration	5	documentation Commissario giudiziale	enumeration	6	documentation <![CDATA[Rappresentante fiscale di soggetto non residente]]>	enumeration	7	documentation Erede	enumeration	8	documentation <![CDATA[Liquidatore - liquidazione volontaria]]>	enumeration	9	documentation <![CDATA[Soggetto tenuto a presentare dichiarazione in caso di operazioni straordinarie]]>	enumeration	10	documentation <![CDATA[Rappresentante fiscale di soggetto non residente con le limitazioni di cui all'art. 44, comma 3, del D.L. n.331/1993]]>	enumeration	11	documentation <![CDATA[Soggetto esercente l'attività tutoria del minore o interdetto in relazione alla funzione istituzionale rivestita]]>	enumeration	12	documentation <![CDATA[Liquidatore - liquidazione volontaria di ditta individuale periodo ante messa in liquidazione]]>	enumeration	13	documentation Amministratore di condominio	enumeration	14	documentation <![CDATA[Soggetto che sottoscrive la dichiarazione per conto di una pubblica amministrazione]]>
Kind	Value	annotation																																															
pattern	[1-9]{1}[0-9]*																																																
enumeration	1	documentation Rappresentante legale, negoziale o di fatto, socio amministratore																																															
enumeration	2	documentation <![CDATA[Rappresentante di minore, inabilitato o interdetto, amministratore di sostegno, ovvero curatore dell'eredità giacente, amministratore dell'eredità]]>																																															
enumeration	3	documentation Curatore fallimentare																																															
enumeration	4	documentation Commissario liquidatore																																															
enumeration	5	documentation Commissario giudiziale																																															
enumeration	6	documentation <![CDATA[Rappresentante fiscale di soggetto non residente]]>																																															
enumeration	7	documentation Erede																																															
enumeration	8	documentation <![CDATA[Liquidatore - liquidazione volontaria]]>																																															
enumeration	9	documentation <![CDATA[Soggetto tenuto a presentare dichiarazione in caso di operazioni straordinarie]]>																																															
enumeration	10	documentation <![CDATA[Rappresentante fiscale di soggetto non residente con le limitazioni di cui all'art. 44, comma 3, del D.L. n.331/1993]]>																																															
enumeration	11	documentation <![CDATA[Soggetto esercente l'attività tutoria del minore o interdetto in relazione alla funzione istituzionale rivestita]]>																																															
enumeration	12	documentation <![CDATA[Liquidatore - liquidazione volontaria di ditta individuale periodo ante messa in liquidazione]]>																																															
enumeration	13	documentation Amministratore di condominio																																															
enumeration	14	documentation <![CDATA[Soggetto che sottoscrive la dichiarazione per conto di una pubblica amministrazione]]>																																															

	enumeration 15	documentation <![CDATA[Commissario liquidatore di una pubblica amministrazione]]>
source	<code><xs:element name="CodiceCarica" type="Codice_Carica_Type"/></code>	

element Dati_Sottoscrittore_Type/CodiceFiscaleSocieta

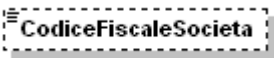
diagram		
namespace	urn:www.agenziaentrate.gov.it:specificheTecniche:sco:common:v2	
type	DatoCN_Type	
properties	isRef 0 minOcc 0 maxOcc 1 content simple	
facets	Kind Value annotation length 11 pattern [0-9]{11}	
source	<code><xs:element name="CodiceFiscaleSocieta" type="cm:DatoCN_Type" minOccurs="0"/></code>	

element Dati_Sottoscrittore_Type/DatiAnagrafici

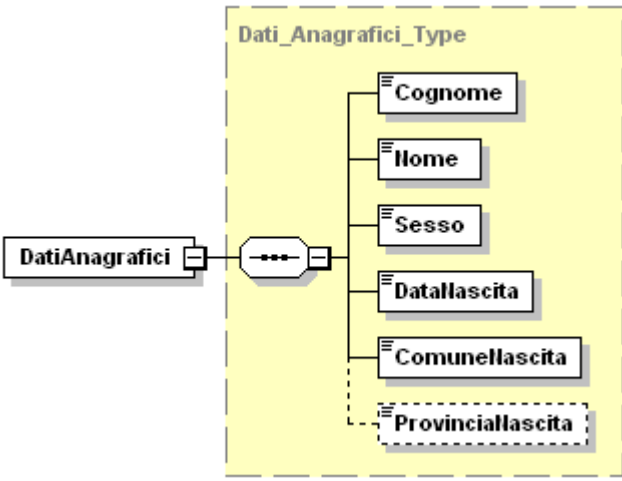
diagram		
namespace	urn:www.agenziaentrate.gov.it:specificheTecniche:sco:common:v2	
type	Dati_Anagrafici_Type	
properties	isRef 0 content complex	
children	Cognome Nome Sesso DataNascita ComuneNascita ProvinciaNascita	
source	<code><xs:element name="DatiAnagrafici" type="Dati_Anagrafici_Type"/></code>	

element **Dati_Sottoscrittore_Type/ResidenzaEstera**

diagram									
namespace	urn:www.agenziaentrate.gov.it:specificheTecniche:sco:common:v2								
type	Residenza_Estera_Type								
properties	<table border="0"> <tr><td>isRef</td><td>0</td></tr> <tr><td>minOcc</td><td>0</td></tr> <tr><td>maxOcc</td><td>1</td></tr> <tr><td>content</td><td>complex</td></tr> </table>	isRef	0	minOcc	0	maxOcc	1	content	complex
isRef	0								
minOcc	0								
maxOcc	1								
content	complex								
children	CodiceStatoEstero StatoFederato LocalitaEstero IndirizzoEstero								
source	<pre><xs:element name="ResidenzaEstera" type="Residenza_Estera_Type" minOccurs="0"/></pre>								

element **Dati_Sottoscrittore_Type/Telefono**

diagram									
namespace	urn:www.agenziaentrate.gov.it:specificheTecniche:sco:common:v2								
type	DatoTL_Type								
properties	<table border="0"> <tr><td>isRef</td><td>0</td></tr> <tr><td>minOcc</td><td>0</td></tr> <tr><td>maxOcc</td><td>1</td></tr> <tr><td>content</td><td>simple</td></tr> </table>	isRef	0	minOcc	0	maxOcc	1	content	simple
isRef	0								
minOcc	0								
maxOcc	1								
content	simple								
facets	<table border="0"> <tr><td>Kind</td><td>Value</td><td>annotation</td></tr> <tr><td>pattern</td><td>[0-9]*</td><td></td></tr> </table>	Kind	Value	annotation	pattern	[0-9]*			
Kind	Value	annotation							
pattern	[0-9]*								
source	<pre><xs:element name="Telefono" type="cm:DatoTL_Type" minOccurs="0"/></pre>								

element **Dati_Sottoscrittore_Type/DataCarica**

diagram									
namespace	urn:www.agenziaentrate.gov.it:specificheTecniche:sco:common:v2								
type	DatoDT_Type								
properties	<table border="0"> <tr><td>isRef</td><td>0</td></tr> <tr><td>minOcc</td><td>0</td></tr> <tr><td>maxOcc</td><td>1</td></tr> <tr><td>content</td><td>simple</td></tr> </table>	isRef	0	minOcc	0	maxOcc	1	content	simple
isRef	0								
minOcc	0								
maxOcc	1								
content	simple								
facets	<table border="0"> <tr><td>Kind</td><td>Value</td><td>annotation</td></tr> <tr><td></td><td></td><td></td></tr> </table>	Kind	Value	annotation					
Kind	Value	annotation							

	length 8 pattern ((([0-9]{12}[0-9]{3}[01])(0[13578][10]12)\d{4})) ((([0-9]{1-9}[12][0-9]{30})(0[469][11]\d{4})) ((0[1-9][1[0-9]]2[0-8])(02)\d{4})) ((29)(02)([02468][048]00)) ((29)(02)([13579][26]00)) ((29)(02)([0-9][0-9][0][48])) ((29)(02)([0-9][0-9][2468][048])) ((29)(02)([0-9][0-9][13579][26]))
source	<code><xs:element name="DataCarica" type="cm:DatoDT_Type" minOccurs="0"/></code>

element Dati_Sottoscrittore_Type/InizioProcedura

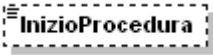
diagram	
namespace	urn:www.agenziaentrate.gov.it:specificheTecniche:sco:common:v2
type	DatoDT_Type
properties	isRef 0 minOcc 0 maxOcc 1 content simple
facets	Kind Value annotation length 8 pattern ((([0-9]{12}[0-9]{3}[01])(0[13578][10]12)\d{4})) ((([0-9]{1-9}[12][0-9]{30})(0[469][11]\d{4})) ((0[1-9][1[0-9]]2[0-8])(02)\d{4})) ((29)(02)([02468][048]00)) ((29)(02)([13579][26]00)) ((29)(02)([0-9][0-9][0][48])) ((29)(02)([0-9][0-9][2468][048])) ((29)(02)([0-9][0-9][13579][26]))
source	<code><xs:element name="InizioProcedura" type="cm:DatoDT_Type" minOccurs="0"/></code>

element Dati_Sottoscrittore_Type/ProceduraNonTerminata

diagram	
namespace	urn:www.agenziaentrate.gov.it:specificheTecniche:sco:common:v2
type	DatoCB_Type
properties	isRef 0 minOcc 0 maxOcc 1 content simple
facets	Kind Value annotation pattern [01]
source	<code><xs:element name="ProceduraNonTerminata" type="cm:DatoCB_Type" minOccurs="0"/></code>

element Dati_Sottoscrittore_Type/FineProcedura

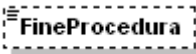
diagram	
namespace	urn:www.agenziaentrate.gov.it:specificheTecniche:sco:common:v2
type	DatoDT_Type
properties	isRef 0 minOcc 0

	maxOcc 1 content simple	
facets	Kind Value length 8 pattern ((([0-9][12][0-9]3[01])([013578]1012)(\d{4})) ([0][1-9][12][0-9]30)([0469]11)(\d{4})) ([01-9]1[0-9]2[0-8](02)(\d{4})) ((29)(02)([02468][048]00)) ((29)(02)([13579][26]00)) ((29)(02)([0-9][0-9][0][48])) ((29)(02)([0-9][0-9][2468][048])) ((29)(02)([0-9][0-9][13579][26]))	annotation
source	<code><xs:element name="FineProcedura" type="cm:DatoDT_Type" minOccurs="0"/></code>	

complexType Domicilio_EE_Type

diagram		
namespace	urn:www.agenziaentrate.gov.it:specificheTecniche:sco:common:v2	
children	Comune Provincia CodiceComune Indirizzo Cap DataVariazione	
used by	element	Soggetti Diversi Da PF Type/SedeLegale
source	<pre> <xs:complexType name="Domicilio_EE_Type"> <xs:sequence> <xs:element name="Comune" type="cm:DatoAN_Type"/> <xs:element name="Provincia" type="cm:PE_Type" minOccurs="0"/> <xs:element name="CodiceComune" type="cm:DatoAN_Type" minOccurs="0"/> <xs:element name="Indirizzo" type="cm:DatoAN_Type" minOccurs="0"/> <xs:element name="Cap" type="cm:DatoCP_Type" minOccurs="0"/> <xs:element name="DataVariazione" type="cm:DatoD6_Type" minOccurs="0"/> </xs:sequence> </xs:complexType> </pre>	

element Domicilio_EE_Type/Comune

diagram	
---------	--

namespace	urn:www.agenziaentrate.gov.it:specificheTecniche:sco:common:v2
type	DatoAN_Type
properties	isRef 0 content simple
facets	Kind Value annotation pattern [0-9A-Z-]{1}([0-9A-Z] \\- \\. & \\s / ^ \\(\\))*
source	<code><xs:element name="Comune" type="cm:DatoAN_Type"/></code>

element **Domicilio_EE_Type/Provincia**

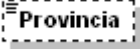
diagram	
namespace	urn:www.agenziaentrate.gov.it:specificheTecniche:sco:common:v2
type	PE_Type
properties	isRef 0 minOcc 0 maxOcc 1 content simple
source	<code><xs:element name="Provincia" type="cm:PE_Type" minOccurs="0"/></code>

element **Domicilio_EE_Type/CodiceComune**

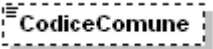
diagram	
namespace	urn:www.agenziaentrate.gov.it:specificheTecniche:sco:common:v2
type	DatoAN_Type
properties	isRef 0 minOcc 0 maxOcc 1 content simple
facets	Kind Value annotation pattern [0-9A-Z-]{1}([0-9A-Z] \\- \\. & \\s / ^ \\(\\))*
source	<code><xs:element name="CodiceComune" type="cm:DatoAN_Type" minOccurs="0"/></code>

element **Domicilio_EE_Type/Indirizzo**

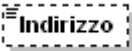
diagram	
namespace	urn:www.agenziaentrate.gov.it:specificheTecniche:sco:common:v2
type	DatoAN_Type
properties	isRef 0 minOcc 0 maxOcc 1 content simple
facets	Kind Value annotation

	pattern [0-9A-Z-]{1}([0-9A-Z] [- \. & _ ! @ / ° ~ \\(\)])*
source	<code><xs:element name="Indirizzo" type="cm:DatoAN_Type" minOccurs="0"/></code>

element Domicilio_EE_Type/Cap

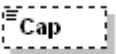
diagram	
namespace	urn:www.agenziaentrate.gov.it:specificheTecniche:sco:common:v2
type	DatoCP_Type
properties	isRef 0 minOcc 0 maxOcc 1 content simple
facets	Kind Value annotation pattern [0-9]{5}
source	<code><xs:element name="Cap" type="cm:DatoCP_Type" minOccurs="0"/></code>

element Domicilio_EE_Type/DataVariazione

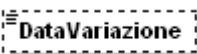
diagram	
namespace	urn:www.agenziaentrate.gov.it:specificheTecniche:sco:common:v2
type	DatoD6_Type
properties	isRef 0 minOcc 0 maxOcc 1 content simple
facets	Kind Value annotation length 6 pattern ((0[0-9]) (1[0-2]))((19 20)[0-9][0-9])
source	<code><xs:element name="DataVariazione" type="cm:DatoD6_Type" minOccurs="0"/></code>

complexType **Domicilio_Fiscale_Type**

diagram	
namespace	urn:www.agenziaentrate.gov.it:specificheTecniche:sco:common:v2
type	extension of Domicilio_Ita_Type
properties	base Domicilio_Ita_Type
children	Comune Provincia CodiceComune Indirizzo Cap DataVariazione
used by	element Soggetti_Diversi_Da_PF_Type/DomicilioFiscale
source	<pre> <xs:complexType name="Domicilio_Fiscale_Type"> <xs:complexContent> <xs:extension base="Domicilio_Ita_Type"> <xs:sequence> <xs:element name="DataVariazione" type="cm:DatoD6_Type" minOccurs="0"/> </xs:sequence> </xs:extension> </xs:complexContent> </xs:complexType> </pre>

element **Domicilio_Fiscale_Type/DataVariazione**

diagram	
namespace	urn:www.agenziaentrate.gov.it:specificheTecniche:sco:common:v2
type	DatoD6_Type
properties	isRef 0 minOcc 0 maxOcc 1 content simple
facets	Kind Value annotation length 6 pattern ((0[0-9]) (1[0-2]))((19 20)[0-9][0-9])
source	<pre> <xs:element name="DataVariazione" type="cm:DatoD6_Type" </pre>

	<code>minOccurs="0"/></code>
--	---------------------------------

complexType Domicilio_Ita_Type

diagram					
namespace	urn:www.agenziaentrate.gov.it:specificheTecniche:sco:common:v2				
children	Comune Provincia CodiceComune Indirizzo Cap				
used by	<table border="0"> <tr> <td style="padding-right: 10px;">element</td> <td>Intestazione_730_Type/UfficioPerifericoCaf</td> </tr> <tr> <td>complexType</td> <td>Domicilio_Fiscale_Type Residenza_Anagrafica_Type Residenza_Rappresentante_Type</td> </tr> </table>	element	Intestazione_730_Type/UfficioPerifericoCaf	complexType	Domicilio_Fiscale_Type Residenza_Anagrafica_Type Residenza_Rappresentante_Type
element	Intestazione_730_Type/UfficioPerifericoCaf				
complexType	Domicilio_Fiscale_Type Residenza_Anagrafica_Type Residenza_Rappresentante_Type				
source	<pre><xs:complexType name="Domicilio_Ita_Type"> <xs:sequence> <xs:element name="Comune" type="cm:DatoAN_Type"/> <xs:element name="Provincia" type="cm:PR_Type"/> <xs:element name="CodiceComune" type="cm:DatoAN_Type"/> <xs:element name="Indirizzo" type="cm:DatoAN_Type"/> <xs:element name="Cap" type="cm:DatoCP_Type"/> </xs:sequence> </xs:complexType></pre>				

element Domicilio_Ita_Type/Comune

diagram							
namespace	urn:www.agenziaentrate.gov.it:specificheTecniche:sco:common:v2						
type	DatoAN_Type						
properties	<table border="0"> <tr> <td>isRef</td> <td>0</td> </tr> <tr> <td>content</td> <td>simple</td> </tr> </table>	isRef	0	content	simple		
isRef	0						
content	simple						
facets	<table border="0"> <tr> <td>Kind</td> <td>Value</td> <td>annotation</td> </tr> <tr> <td>pattern</td> <td>[0-9A-Z-]{1}([0-9A-Z] \\- \\. &#x20; _ \\s / ° \\(\\))*</td> <td></td> </tr> </table>	Kind	Value	annotation	pattern	[0-9A-Z-]{1}([0-9A-Z] \\- \\. _ \\s / ° \\(\\))*	
Kind	Value	annotation					
pattern	[0-9A-Z-]{1}([0-9A-Z] \\- \\. _ \\s / ° \\(\\))*						
source	<pre><xs:element name="Comune" type="cm:DatoAN_Type"/></pre>						

element Domicilio_Ita_Type/Provincia

diagram	
namespace	urn:www.agenziaentrate.gov.it:specificheTecniche:sco:common:v2

type	PR_Type
properties	isRef 0 content simple
source	<code><xs:element name="Provincia" type="cm:PR_Type"/></code>

element Domicilio_Ita_Type/CodiceComune

diagram	
namespace	urn:www.agenziaentrate.gov.it:specificheTecniche:sco:common:v2
type	DatoAN_Type
properties	isRef 0 content simple
facets	Kind Value annotation pattern <code>[0-9A-Z-]{1}([0-9A-Z] \- \. &amp; _ \\s / ° \\(\\))*</code>
source	<code><xs:element name="CodiceComune" type="cm:DatoAN_Type"/></code>

element Domicilio_Ita_Type/Indirizzo

diagram	
namespace	urn:www.agenziaentrate.gov.it:specificheTecniche:sco:common:v2
type	DatoAN_Type
properties	isRef 0 content simple
facets	Kind Value annotation pattern <code>[0-9A-Z-]{1}([0-9A-Z] \- \. &amp; _ \\s / ° \\(\\))*</code>
source	<code><xs:element name="Indirizzo" type="cm:DatoAN_Type"/></code>

element Domicilio_Ita_Type/Cap

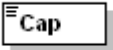
diagram	
namespace	urn:www.agenziaentrate.gov.it:specificheTecniche:sco:common:v2
type	DatoCP_Type
properties	isRef 0 content simple
facets	Kind Value annotation pattern <code>[0-9]{5}</code>
source	<code><xs:element name="Cap" type="cm:DatoCP_Type"/></code>

complexType Firma_Revisione_Type

diagram	
namespace	urn:www.agenziaentrate.gov.it:specificheTecniche:sco:common:v2
children	Soggetto CodiceFiscale FirmaDichiarante
source	<pre> <xs:complexType name="Firma_Revisione_Type"> <xs:sequence> <xs:element name="Soggetto" minOccurs="0"> <xs:simpleType> <xs:restriction base="cm:DatoNP_Type"> <xs:pattern value="[1-4]" /> </xs:restriction> </xs:simpleType> </xs:element> <xs:element name="CodiceFiscale" type="cm:DatoCF_Type" minOccurs="0"/> <xs:element name="FirmaDichiarante" type="cm:DatoCB_Type" minOccurs="0"/> </xs:sequence> </xs:complexType> </pre>

element Firma_Revisione_Type/Soggetto

diagram	
namespace	urn:www.agenziaentrate.gov.it:specificheTecniche:sco:common:v2
type	restriction of DatoNP_Type
properties	isRef 0 minOcc 0 maxOcc 1 content simple
facets	Kind Value annotation pattern [1-4]
source	<pre> <xs:element name="Soggetto" minOccurs="0"> <xs:simpleType> <xs:restriction base="cm:DatoNP_Type"> <xs:pattern value="[1-4]" /> </xs:restriction> </xs:simpleType> </xs:element> </pre>

element **Firma_Revisore_Type/CodiceFiscale**

diagram	
namespace	urn:www.agenziaentrate.gov.it:specificheTecniche:sco:common:v2
type	DatoCF_Type
properties	isRef 0 minOcc 0 maxOcc 1 content simple
facets	Kind Value annotation pattern [0-9]{11}[A-Z]{6}[0-9LMNPQRSTUUV]{2}[A-Z]{1}[0-9LMNPQRSTUUV]{2}[A-Z]{1}[0-9LMNPQRSTUUV]{3}[A-Z]{1}
source	<pre><xs:element name="CodiceFiscale" type="cm:DatoCF_Type" minOccurs="0"/></pre>

element **Firma_Revisore_Type/FirmaDichiarante**

diagram	
namespace	urn:www.agenziaentrate.gov.it:specificheTecniche:sco:common:v2
type	DatoCB_Type
properties	isRef 0 minOcc 0 maxOcc 1 content simple
facets	Kind Value annotation pattern [01]
source	<pre><xs:element name="FirmaDichiarante" type="cm:DatoCB_Type" minOccurs="0"/></pre>

complexType **Firma_Type**

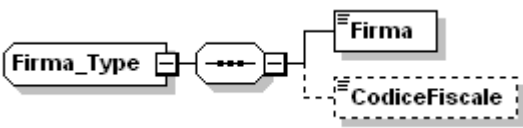
diagram	
namespace	urn:www.agenziaentrate.gov.it:specificheTecniche:sco:common:v2
children	Firma CodiceFiscale
used by	elements Scelta5PerMille_Type/RicercaSanitaria Scelta5PerMille_Type/RicercaScientifica Scelta5PerMille_Type/SostegnoAssociazioniSportive Scelta5PerMille_Type/SostegnoVolontariatoNonLucrative
source	<pre><xs:complexType name="Firma_Type"> <xs:sequence> <xs:element name="Firma" type="cm:DatoCB_Type"/> <xs:element name="CodiceFiscale" type="cm:DatoAN_Type" minOccurs="0"/> </xs:sequence></pre>

	<code></xs:complexType></code>
--	--------------------------------------

element Firma_Type/Firma

diagram	
namespace	urn:www.agenziaentrate.gov.it:specificheTecniche:sco:common:v2
type	DatoCB_Type
properties	isRef 0 content simple
facets	Kind Value annotation pattern [01]
source	<code><xs:element name="Firma" type="cm:DatoCB_Type"/></code>

element Firma_Type/CodiceFiscale

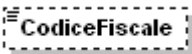
diagram	
namespace	urn:www.agenziaentrate.gov.it:specificheTecniche:sco:common:v2
type	DatoAN_Type
properties	isRef 0 minOcc 0 maxOcc 1 content simple
facets	Kind Value annotation pattern [0-9A-Z]{1}([0-9A-Z] \- \. & _ s / ° ^\(\))*
source	<code><xs:element name="CodiceFiscale" type="cm:DatoAN_Type" minOccurs="0"/></code>

complexType Frontespizio_Type

diagram	
namespace	urn:www.agenziaentrate.gov.it:specificheTecniche:sco:common:v2
children	SoggettoFiscale
source	<code><xs:complexType name="Frontespizio_Type"> <xs:sequence> <xs:element name="SoggettoFiscale" type="Soggetto_Fiscale_Type"/> </xs:sequence> </xs:complexType></code>

element **Frontespizio_Type/SoggettoFiscale**

diagram	
namespace	urn:www.agenziaentrate.gov.it:specificheTecniche:sco:common:v2
type	Soggetto_Fiscale_Type
properties	isRef 0 content complex
children	CodiceFiscale Email Telefono Fax
source	<pre><xs:element name="SoggettoFiscale" type="Soggetto_Fiscale_Type"/></pre>

complexType **Impegno_A_Trasmettere_Type**

diagram	
namespace	urn:www.agenziaentrate.gov.it:specificheTecniche:sco:common:v2
children	CFintermediario NumeroIscrAlboCAF ImpegnoATrasmettere RicezioneAvvisoTelem DataImpegno FirmaIntermediario
source	<pre><xs:complexType name="Impegno_A_Trasmettere_Type"> <xs:sequence> <xs:element name="CFintermediario" type="cm:DatoCF_Type"/> <xs:element name="NumeroIscrAlboCAF" minOccurs="0"> <xs:simpleType> <xs:restriction base="cm:DatoNU_Type"> <xs:maxLength value="5"/> </xs:restriction> </xs:simpleType> </xs:element> </xs:sequence> </xs:complexType></pre>

	<pre> </xs:element> <xs:element name="ImpegnoATrasmettere"> <xs:simpleType> <xs:restriction base="cm:DatoNP_Type"> <xs:pattern value="1 2"/> <xs:enumeration value="1"/> <xs:enumeration value="2"/> </xs:restriction> </xs:simpleType> </xs:element> <xs:element name="RicezioneAvvisoTelem" type="cm:DatoCB_Type" minOccurs="0"/> <xs:element name="DataImpegno" type="cm:DatoDT_Type"/> <xs:element name="FirmaIntermediario" type="cm:DatoCB_Type"/> </xs:sequence> </xs:complexType> </pre>
--	--

element Impegno_A_Trasmettere_Type/CFintermediario

diagram	
namespace	urn:www.agenziaentrate.gov.it:specificheTecniche:sco:common:v2
type	DatoCF_Type
properties	isRef 0 content simple
facets	Kind Value annotation pattern [0-9]{11}[A-Z]{6}[0-9LMNPQRSTU]{2}[A-Z]{1}[0-9LMNPQRSTU]{2}[A-Z]{1}[0-9LMNPQRSTU]{3}[A-Z]{1}
source	<pre><xs:element name="CFintermediario" type="cm:DatoCF_Type"/></pre>

element Impegno_A_Trasmettere_Type/NumeroIscrAlboCAF

diagram	
namespace	urn:www.agenziaentrate.gov.it:specificheTecniche:sco:common:v2
type	restriction of DatoNU_Type
properties	isRef 0 minOcc 0 maxOcc 1 content simple
facets	Kind Value annotation maxLength 5 pattern (\-[1-9] [1-9])[0-9]*
source	<pre><xs:element name="NumeroIscrAlboCAF" minOccurs="0"> <xs:simpleType> <xs:restriction base="cm:DatoNU_Type"> </pre>

	<pre> <xs:maxLength value="5"/> </xs:restriction> </xs:simpleType> </xs:element> </pre>
--	---

element **Impegno_A_Trasmettere_Type/ImpegnoATrasmettere**

diagram	
namespace	urn:www.agenziaentrate.gov.it:specificheTecniche:sco:common:v2
type	restriction of DatoNP_Type
properties	isRef 0 content simple
facets	Kind Value annotation pattern 1 2 enumeration 1 enumeration 2
source	<pre> <xs:element name="ImpegnoATrasmettere"> <xs:simpleType> <xs:restriction base="cm:DatoNP_Type"> <xs:pattern value="1 2"/> <xs:enumeration value="1"/> <xs:enumeration value="2"/> </xs:restriction> </xs:simpleType> </xs:element> </pre>

element **Impegno_A_Trasmettere_Type/RicezioneAvvisoTelem**

diagram	
namespace	urn:www.agenziaentrate.gov.it:specificheTecniche:sco:common:v2
type	DatoCB_Type
properties	isRef 0 minOcc 0 maxOcc 1 content simple
facets	Kind Value annotation pattern [01]
source	<pre> <xs:element name="RicezioneAvvisoTelem" type="cm:DatoCB_Type" minOccurs="0"/> </pre>

element **Impegno_A_Trasmettere_Type/DatalImpegno**

diagram	
---------	--

namespace	urn:www.agenziaentrate.gov.it:specificheTecniche:sco:common:v2
type	DatoDT_Type
properties	isRef 0 content simple
facets	Kind Value annotation length 8 pattern ((([0-9][1-9][12][0-9][3][01])(0[13578][10 12](\d{4})) ([0][1-9][12][0-9][30](0[469][11](\d{4})) ([0[1-9][1[0-9]2[0-8](02)(\d{4})) ((29)(02)([02468][048]00)) ((29)(02)([13579][26]00)) ((29)(02)([0-9][0-9][0][48])) ((29)(02)([0-9][0-9][2468][048])) ((29)(02)([0-9][0-9][13579][26]))))
source	<code><xs:element name="DataImpegno" type="cm:DatoDT_Type"/></code>

element Impegno_A_Trasmettere_Type/FirmaIntermediario

diagram	
namespace	urn:www.agenziaentrate.gov.it:specificheTecniche:sco:common:v2
type	DatoCB_Type
properties	isRef 0 content simple
facets	Kind Value annotation pattern [01]
source	<code><xs:element name="FirmaIntermediario" type="cm:DatoCB_Type"/></code>

complexType Persone_Fisiche_Type

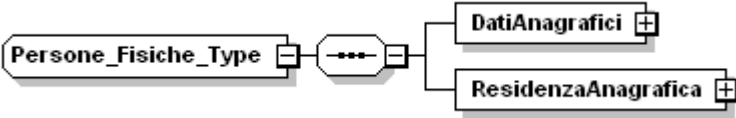
diagram	
namespace	urn:www.agenziaentrate.gov.it:specificheTecniche:sco:common:v2
children	DatiAnagrafici ResidenzaAnagrafica
source	<pre><xs:complexType name="Persone_Fisiche_Type"> <xs:sequence> <xs:element name="DatiAnagrafici" type="Dati_Anagrafici_Type"/> <xs:element name="ResidenzaAnagrafica" type="Residenza_Anagrafica_Type"/> </xs:sequence> </xs:complexType></pre>

element **Persone_Fisiche_Type/DatiAnagrafici**

diagram	
namespace	urn:www.agenziaentrate.gov.it:specificheTecniche:sco:common:v2
type	Dati_Anagrafici_Type
properties	isRef 0 content complex
children	Cognome Nome Sesso DataNascita ComuneNascita ProvinciaNascita
source	<pre><xs:element name="DatiAnagrafici" type="Dati_Anagrafici_Type"/></pre>

element **Persone_Fisiche_Type/ResidenzaAnagrafica**

diagram	
namespace	urn:www.agenziaentrate.gov.it:specificheTecniche:sco:common:v2
type	Residenza_Anagrafica_Type
properties	isRef 0 content complex
children	Comune Provincia CodiceComune Indirizzo Cap DataVariazione
source	<pre><xs:element name="ResidenzaAnagrafica" type="Residenza_Anagrafica_Type"/></pre>

complexType **Residenza_Anagrafica_Type**

diagram	
namespace	urn:www.agenziaentrate.gov.it:specificheTecniche:sco:common:v2
type	extension of Domicilio_Ita_Type
properties	base Domicilio_Ita_Type
children	Comune Provincia CodiceComune Indirizzo Cap DataVariazione
used by	element Persone_Fisiche_Type/ResidenzaAnagrafica complexType Residenza_Anagrafica_730_Type
source	<pre> <xs:complexType name="Residenza_Anagrafica_Type"> <xs:complexContent> <xs:extension base="Domicilio_Ita_Type"> <xs:sequence> <xs:element name="DataVariazione" type="cm:DatoDT_Type" minOccurs="0"/> </xs:sequence> </xs:extension> </xs:complexContent> </xs:complexType> </pre>

element **Residenza_Anagrafica_Type/DataVariazione**

diagram	
namespace	urn:www.agenziaentrate.gov.it:specificheTecniche:sco:common:v2
type	DatoDT_Type
properties	isRef 0 minOcc 0 maxOcc 1 content simple
facets	Kind Value length 8 pattern ((([01-9][12][0-9][301]) (0[13578][10]12)(\d{4})) ((([01-9][12][0-9][30](0[469][11])(\d{4})) ((0[1-

	9][1[0-9][2[0-8](02)(\d{4}))((29)(02)([02468][048]00))((29)(02)([13579][26]00))((29)(02)([0-9][0-9][0][48]))((29)(02)([0-9][0-9][2468][048]))((29)(02)([0-9][0-9][13579][26]))
source	<code><xs:element name="DataVariazione" type="cm:DatoDT_Type" minOccurs="0"/></code>

complexType **Residenza_Estera_Type**

diagram	
namespace	urn:www.agenziaentrate.gov.it:specificheTecniche:sco:common:v2
children	CodiceStatoEstero StatoFederato LocalitaEstero IndirizzoEstero
used by	element Dati_Sottoscrittore_Type/ResidenzaEstera
source	<pre> <xs:complexType name="Residenza_Estera_Type"> <xs:sequence> <xs:element name="CodiceStatoEstero"> <xs:simpleType> <xs:restriction base="cm:DatoAN_Type"> <xs:maxLength value="3"/> <xs:minLength value="3"/> </xs:restriction> </xs:simpleType> </xs:element> <xs:element name="StatoFederato" minOccurs="0"> <xs:simpleType> <xs:restriction base="cm:DatoAN_Type"> <xs:maxLength value="24"/> </xs:restriction> </xs:simpleType> </xs:element> <xs:element name="LocalitaEstero" type="cm:DatoAN_Type" minOccurs="0"/> <xs:element name="IndirizzoEstero" type="cm:DatoAN_Type"/> </xs:sequence> </xs:complexType> </pre>

element **Residenza_Estera_Type/CodiceStatoEstero**

diagram	
---------	--

namespace	urn:www.agenziaentrate.gov.it:specificheTecniche:sco:common:v2
type	restriction of DatoAN_Type
properties	isRef 0 content simple
facets	Kind Value annotation minLength 3 maxLength 3 pattern [0-9A-Z]{1}([0-9A-Z] \- \. & _ \/ ° ^\ \\)*
source	<pre><xs:element name="CodiceStatoEstero"> <xs:simpleType> <xs:restriction base="cm:DatoAN_Type"> <xs:maxLength value="3"/> <xs:minLength value="3"/> </xs:restriction> </xs:simpleType> </xs:element></pre>

element **Residenza_Estera_Type/StatoFederato**

diagram	
namespace	urn:www.agenziaentrate.gov.it:specificheTecniche:sco:common:v2
type	restriction of DatoAN_Type
properties	isRef 0 minOcc 0 maxOcc 1 content simple
facets	Kind Value annotation maxLength 24 pattern [0-9A-Z]{1}([0-9A-Z] \- \. & _ \/ ° ^\ \\)*
source	<pre><xs:element name="StatoFederato" minOccurs="0"> <xs:simpleType> <xs:restriction base="cm:DatoAN_Type"> <xs:maxLength value="24"/> </xs:restriction> </xs:simpleType> </xs:element></pre>

element **Residenza_Estera_Type/LocalitaEstero**

diagram	
namespace	urn:www.agenziaentrate.gov.it:specificheTecniche:sco:common:v2
type	DatoAN_Type
properties	isRef 0 minOcc 0 maxOcc 1

	content simple	
facets	Kind Value pattern [0-9A-Z-]{1}([0-9A-Z] \\-\\. \\s / ° \\V\\(\\))*	annotation
source	<code><xs:element name="LocalitaEstera" type="cm:DatoAN_Type" minOccurs="0"/></code>	

element **Residenza_Estera_Type/IndirizzoEstera**

diagram		
namespace	urn:www.agenziaentrate.gov.it:specificheTecniche:sco:common:v2	
type	DatoAN_Type	
properties	isRef 0 content simple	
facets	Kind Value pattern [0-9A-Z-]{1}([0-9A-Z] \\-\\. \\s / ° \\V\\(\\))*	annotation
source	<code><xs:element name="IndirizzoEstera" type="cm:DatoAN_Type"/></code>	

complexType **Soggetti_Diversi_Da_PF_Type**

diagram		
namespace	urn:www.agenziaentrate.gov.it:specificheTecniche:sco:common:v2	
children	Denominazione SedeLegale DomicilioFiscale DataApprovazioneBilancio TermineApprovazioneBilancio InizioPeriodoImposta FinePeriodoImposta Stato NaturaGiuridica Situazione	
source	<code><xs:complexType name="Soggetti_Diversi_Da_PF_Type"> <xs:sequence> <xs:element name="Denominazione" type="cm:DatoAN_Type"/> <xs:element name="SedeLegale" type="Domicilio_EE_Type"/></code>	

```

<xs:element name="DomicilioFiscale"
type="Domicilio_Fiscale_Type" minOccurs="0"/>
<xs:element name="DataApprovazioneBilancio"
type="cm:DatoDT_Type" minOccurs="0"/>
<xs:element name="TermineApprovazioneBilancio"
type="cm:DatoDT_Type" minOccurs="0"/>
<xs:element name="InizioPeriodoImposta"
type="cm:DatoDT_Type"/>
<xs:element name="FinePeriodoImposta"
type="cm:DatoDT_Type"/>
<xs:element name="Stato" type="Stato_Type"/>
<xs:element name="NaturaGiuridica"
type="Natura_Giuridica_Type"/>
<xs:element name="Situazione" type="Situazione_Type"/>
</xs:sequence>
</xs:complexType>

```

element **Soggetti_Diversi_Da_PF_Type/Denominazione**

diagram	
namespace	urn:www.agenziaentrate.gov.it:specificheTecniche:sco:common:v2
type	DatoAN_Type
properties	isRef 0 content simple
facets	Kind Value annotation pattern [0-9A-Z]{1}([0-9A-Z] \. \& , s / \^\ \\)*
source	<code><xs:element name="Denominazione" type="cm:DatoAN_Type"/></code>

element **Soggetti_Diversi_Da_PF_Type/SedeLegale**

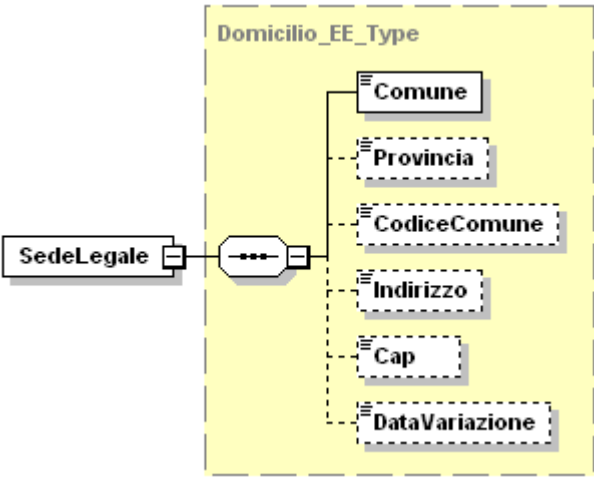
diagram	
namespace	urn:www.agenziaentrate.gov.it:specificheTecniche:sco:common:v2

type	Domicilio EE Type
properties	isRef 0 content complex
children	Comune Provincia CodiceComune Indirizzo Cap DataVariazione
source	<code><xs:element name="SedeLegale" type="Domicilio_EE_Type"/></code>

element **Soggetti_Diversi_Da_PF_Type/DomicilioFiscale**

diagram	
namespace	urn:www.agenziaentrate.gov.it:specificheTecniche:sco:common:v2
type	Domicilio Fiscale Type
properties	isRef 0 minOcc 0 maxOcc 1 content complex
children	Comune Provincia CodiceComune Indirizzo Cap DataVariazione
source	<code><xs:element name="DomicilioFiscale" type="Domicilio_Fiscale_Type" minOccurs="0"/></code>

element **Soggetti_Diversi_Da_PF_Type/DataApprovazioneBilancio**

diagram	
namespace	urn:www.agenziaentrate.gov.it:specificheTecniche:sco:common:v2
type	DatoDT Type
properties	isRef 0 minOcc 0 maxOcc 1 content simple
facets	Kind Value length 8 pattern <code>((([0-9]{12}[0-9]{3}[01])(0[13578][10]12)\d{4}))((([0-9]{12}[0-9]{30}(0[469][11])\d{4}))((0[1-9][1[0-9]2[0-8])(02)\d{4}))((29)(02)([02468][048]00))((29)(02)([13579][26]00))((29)(02)([0-9][0-9][0][48]))((29)(02)([0-9][0-9][2468][048]))((29)(02)([0-9][0-9][13579][26]))))</code> annotation
source	<code><xs:element name="DataApprovazioneBilancio"</code>

	<code>type="cm:DatoDT_Type" minOccurs="0"/></code>
--	---

element **Soggetti_Diversi_Da_PF_Type/TermineApprovazioneBilancio**

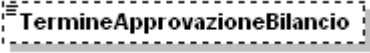
diagram	
namespace	urn:www.agenziaentrate.gov.it:specificheTecniche:sco:common:v2
type	DatoDT_Type
properties	isRef 0 minOcc 0 maxOcc 1 content simple
facets	Kind Value annotation length 8 pattern (((([0-9]{12}[0-9]{3}01))([013578]{10}12)\d{4}))((([0-9]{12}[0-9]{3}0)([0469]{11})\d{4}))((([0-9]{1}[0-9]{2}[0-8])(02)\d{4}))((29)(02)([02468]{048}00))((29)(02)([13579]{26}00))((29)(02)([0-9]{0-9}[0]{48}))((29)(02)([0-9]{0-9}[2468]{048}))((29)(02)([0-9]{0-9}[13579]{26}))
source	<code><xs:element name="TermineApprovazioneBilancio" type="cm:DatoDT_Type" minOccurs="0"/></code>

element **Soggetti_Diversi_Da_PF_Type/InizioPeriodoImposta**

diagram	
namespace	urn:www.agenziaentrate.gov.it:specificheTecniche:sco:common:v2
type	DatoDT_Type
properties	isRef 0 content simple
facets	Kind Value annotation length 8 pattern (((([0-9]{12}[0-9]{3}01))([013578]{10}12)\d{4}))((([0-9]{12}[0-9]{3}0)([0469]{11})\d{4}))((([0-9]{1}[0-9]{2}[0-8])(02)\d{4}))((29)(02)([02468]{048}00))((29)(02)([13579]{26}00))((29)(02)([0-9]{0-9}[0]{48}))((29)(02)([0-9]{0-9}[2468]{048}))((29)(02)([0-9]{0-9}[13579]{26}))
source	<code><xs:element name="InizioPeriodoImposta" type="cm:DatoDT_Type"/></code>

element **Soggetti_Diversi_Da_PF_Type/FinePeriodoImposta**

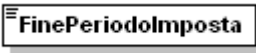
diagram	
namespace	urn:www.agenziaentrate.gov.it:specificheTecniche:sco:common:v2
type	DatoDT_Type
properties	isRef 0 content simple
facets	Kind Value annotation length 8 pattern (((([0-9]{12}[0-9]{3}01))([013578]{10}12)\d{4}))((([0-9]{12}[0-9]{3}0)([0469]{11})\d{4}))((([0-9]{1}[0-9]{2}[0-8])(02)\d{4}))((29)(02)([02468]{048}00))((29)(02)([13579]{26}00))((29)(02)([0-9]{0-9}[0]{48}))((29)(02)([0-9]{0-9}[2468]{048}))((29)(02)([0-9]{0-9}[13579]{26}))

source	<code><xs:element name="FinePeriodoImposta" type="cm:DatoDT_Type"/></code>
--------	--

element **Soggetti Diversi Da PF_Type/Stato**

diagram																			
namespace	urn:www.agenziaentrate.gov.it:specificheTecniche:sco:common:v2																		
type	Stato_Type																		
properties	isRef 0 content simple																		
facets	<table border="1"> <thead> <tr> <th>Kind</th> <th>Value</th> <th>annotation</th> </tr> </thead> <tbody> <tr> <td>pattern</td> <td>[1-9]{1}[0-9]*</td> <td></td> </tr> <tr> <td>enumeration</td> <td>1</td> <td>documentation <![CDATA[Soggetto in normale attività]]></td> </tr> <tr> <td>enumeration</td> <td>2</td> <td>documentation <![CDATA[Soggetto in liquidazione per cessazione di attività]]></td> </tr> <tr> <td>enumeration</td> <td>3</td> <td>documentation <![CDATA[Soggetto in fallimento o in liquidazione coatta amministrativa]]></td> </tr> <tr> <td>enumeration</td> <td>4</td> <td>documentation <![CDATA[Soggetto estinto]]></td> </tr> </tbody> </table>	Kind	Value	annotation	pattern	[1-9]{1}[0-9]*		enumeration	1	documentation <![CDATA[Soggetto in normale attività]]>	enumeration	2	documentation <![CDATA[Soggetto in liquidazione per cessazione di attività]]>	enumeration	3	documentation <![CDATA[Soggetto in fallimento o in liquidazione coatta amministrativa]]>	enumeration	4	documentation <![CDATA[Soggetto estinto]]>
Kind	Value	annotation																	
pattern	[1-9]{1}[0-9]*																		
enumeration	1	documentation <![CDATA[Soggetto in normale attività]]>																	
enumeration	2	documentation <![CDATA[Soggetto in liquidazione per cessazione di attività]]>																	
enumeration	3	documentation <![CDATA[Soggetto in fallimento o in liquidazione coatta amministrativa]]>																	
enumeration	4	documentation <![CDATA[Soggetto estinto]]>																	
source	<code><xs:element name="Stato" type="Stato_Type"/></code>																		

element **Soggetti Diversi Da PF_Type/NaturaGiuridica**

diagram																																											
namespace	urn:www.agenziaentrate.gov.it:specificheTecniche:sco:common:v2																																										
type	Natura_Giuridica_Type																																										
properties	isRef 0 content simple																																										
facets	<table border="1"> <thead> <tr> <th>Kind</th> <th>Value</th> <th>annotation</th> </tr> </thead> <tbody> <tr> <td>pattern</td> <td>[1-9]{1}[0-9]*</td> <td></td> </tr> <tr> <td>enumeration</td> <td>1</td> <td>documentation <![CDATA[Società in accomandita per azioni]]></td> </tr> <tr> <td>enumeration</td> <td>2</td> <td>documentation <![CDATA[Società a responsabilità limitata]]></td> </tr> <tr> <td>enumeration</td> <td>3</td> <td>documentation <![CDATA[Società per azioni]]></td> </tr> <tr> <td>enumeration</td> <td>4</td> <td>documentation <![CDATA[Società cooperative e loro consorzi iscritti nei registri prefettizi e nello schedario della cooperazione]]></td> </tr> <tr> <td>enumeration</td> <td>5</td> <td>documentation <![CDATA[Altre società cooperative]]></td> </tr> <tr> <td>enumeration</td> <td>6</td> <td>documentation <![CDATA[Mutue assicuratrici]]></td> </tr> <tr> <td>enumeration</td> <td>7</td> <td>documentation <![CDATA[Consorzi con personalità giuridica]]></td> </tr> <tr> <td>enumeration</td> <td>8</td> <td>documentation <![CDATA[Associazioni riconosciute]]></td> </tr> <tr> <td>enumeration</td> <td>9</td> <td>documentation <![CDATA[Fondazioni]]></td> </tr> <tr> <td>enumeration</td> <td>10</td> <td>documentation <![CDATA[Altri enti ed istituti con personalità giuridica]]></td> </tr> <tr> <td>enumeration</td> <td>11</td> <td>documentation <![CDATA[Consorzi senza personalità giuridica]]></td> </tr> <tr> <td>enumeration</td> <td>12</td> <td>documentation</td> </tr> </tbody> </table>	Kind	Value	annotation	pattern	[1-9]{1}[0-9]*		enumeration	1	documentation <![CDATA[Società in accomandita per azioni]]>	enumeration	2	documentation <![CDATA[Società a responsabilità limitata]]>	enumeration	3	documentation <![CDATA[Società per azioni]]>	enumeration	4	documentation <![CDATA[Società cooperative e loro consorzi iscritti nei registri prefettizi e nello schedario della cooperazione]]>	enumeration	5	documentation <![CDATA[Altre società cooperative]]>	enumeration	6	documentation <![CDATA[Mutue assicuratrici]]>	enumeration	7	documentation <![CDATA[Consorzi con personalità giuridica]]>	enumeration	8	documentation <![CDATA[Associazioni riconosciute]]>	enumeration	9	documentation <![CDATA[Fondazioni]]>	enumeration	10	documentation <![CDATA[Altri enti ed istituti con personalità giuridica]]>	enumeration	11	documentation <![CDATA[Consorzi senza personalità giuridica]]>	enumeration	12	documentation
Kind	Value	annotation																																									
pattern	[1-9]{1}[0-9]*																																										
enumeration	1	documentation <![CDATA[Società in accomandita per azioni]]>																																									
enumeration	2	documentation <![CDATA[Società a responsabilità limitata]]>																																									
enumeration	3	documentation <![CDATA[Società per azioni]]>																																									
enumeration	4	documentation <![CDATA[Società cooperative e loro consorzi iscritti nei registri prefettizi e nello schedario della cooperazione]]>																																									
enumeration	5	documentation <![CDATA[Altre società cooperative]]>																																									
enumeration	6	documentation <![CDATA[Mutue assicuratrici]]>																																									
enumeration	7	documentation <![CDATA[Consorzi con personalità giuridica]]>																																									
enumeration	8	documentation <![CDATA[Associazioni riconosciute]]>																																									
enumeration	9	documentation <![CDATA[Fondazioni]]>																																									
enumeration	10	documentation <![CDATA[Altri enti ed istituti con personalità giuridica]]>																																									
enumeration	11	documentation <![CDATA[Consorzi senza personalità giuridica]]>																																									
enumeration	12	documentation																																									

		<![CDATA[Associazioni non riconosciute e comitati]]>
enumeration	13	documentation
enumeration	14	<![CDATA[Altre organizzazioni di persone o beni senza personalità giuridica, escluse le comunioni]]>
enumeration	15	documentation
enumeration	16	<![CDATA[Enti pubblici economici]]>
enumeration	17	documentation
enumeration	18	<![CDATA[Enti pubblici non economici]]>
enumeration	19	documentation
enumeration	20	<![CDATA[Casse mutue e fondi previdenza, assistenza, pensioni o simili con o senza personalità giuridica]]>
enumeration	21	documentation
enumeration	22	<![CDATA[Opere pie e società di mutuo soccorso]]>
enumeration	23	documentation
enumeration	24	<![CDATA[Enti ospedalieri]]>
enumeration	25	documentation
enumeration	26	<![CDATA[Enti ed istituti di previdenza e di assistenza sociale]]>
enumeration	27	documentation
enumeration	28	<![CDATA[Aziende autonome di cura, soggiorno e turismo]]>
enumeration	29	documentation
enumeration	30	<![CDATA[Aziende regionali, provinciali, comunali e loro consorzi]]>
enumeration	31	documentation
enumeration	32	<![CDATA[Società, organizzazioni ed enti costituiti all'estero non altrimenti classificabili con sede dell'amministrazione od oggetto principale in Italia]]>
enumeration	33	documentation
enumeration	34	<![CDATA[Società semplici ed equiparate, art.5, comma 3 lett.b del Tuir]]>
enumeration	35	documentation
enumeration	36	<![CDATA[Società in nome collettivo ed equiparate ai sensi dell'art. 5, comma 3, lett. b, del TUIR]]>
enumeration	37	documentation
enumeration	38	<![CDATA[Società in accomandita semplice]]>
enumeration	39	documentation
enumeration	40	<![CDATA[Società di armamento]]>
enumeration	41	documentation
enumeration	42	<![CDATA[Associazioni fra artisti e professionisti]]>
enumeration	43	documentation
enumeration	44	<![CDATA[Aziende coniugali]]>
enumeration	45	documentation
enumeration	46	<![CDATA[GEIE (Gruppi europei di interesse economico)]]>
enumeration	47	documentation
enumeration	48	<![CDATA[Soggetti non residenti - Società semplici, irregolari e di fatto]]>
enumeration	49	documentation
enumeration	50	<![CDATA[Soggetti non residenti - Società in nome collettivo]]>
enumeration	51	documentation
enumeration	52	<![CDATA[Soggetti non residenti - Società in accomandita semplice]]>
enumeration	53	documentation
enumeration	54	<![CDATA[Soggetti non residenti - Società di armamento]]>
enumeration	55	documentation
enumeration	56	<![CDATA[Soggetti non residenti - Associazioni fra professionisti]]>
enumeration	57	documentation
enumeration	58	<![CDATA[Soggetti non residenti - Società in accomandita per azioni]]>
enumeration	59	documentation
enumeration	60	<![CDATA[Soggetti non residenti - Società a responsabilità limitata]]>
enumeration	61	documentation
enumeration	62	<![CDATA[Soggetti non residenti - Società per azioni]]>
enumeration	63	documentation
enumeration	64	<![CDATA[Soggetti non residenti - Consorzi]]>
enumeration	65	documentation
enumeration	66	<![CDATA[Soggetti non residenti - Altri enti ed istituti]]>
enumeration	67	documentation
enumeration	68	<![CDATA[Soggetti non residenti - Associazioni riconosciute, non riconosciute e di fatto]]>
enumeration	69	documentation
enumeration	70	<![CDATA[Soggetti non residenti - Fondazioni]]>
enumeration	71	documentation
enumeration	72	<![CDATA[Soggetti non residenti - Opere pie e società di mutuo soccorso]]>
enumeration	73	documentation
enumeration	74	<![CDATA[Soggetti non residenti - Altre organizzazioni di persone e di beni]]>
enumeration	75	documentation

	enumeration 50	<![CDATA[Soggetti non residenti - Trust]]> documentation <![CDATA[Società per azioni, aziende speciali e consorzi artt. 31, 113, 114, 115 e 116 del D.Lgs 18/8/2000 n.267]]>
	enumeration 51	documentation <![CDATA[Condomini]]>
	enumeration 52	documentation <![CDATA[Depositi IVA]]>
	enumeration 53	documentation <![CDATA[Società sportive dilettantistiche costituite in società di capitali senza fini di lucro]]>
	enumeration 54	documentation <![CDATA[Trust]]>
	enumeration 55	documentation <![CDATA[Amministrazioni pubbliche]]>
	enumeration 56	documentation <![CDATA[Fondazioni bancarie]]>
	enumeration 57	documentation <![CDATA[Società europea]]>
	enumeration 58	documentation <![CDATA[Società cooperativa europea]]>
source	<code><xs:element name="NaturaGiuridica" type="Natura_Giuridica_Type"/></code>	

element **Soggetti Diversi Da PF_Type/Situazione**

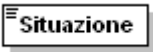
diagram			
namespace	urn:www.agenziaentrate.gov.it:specificheTecniche:sco:common:v2		
type	Situazione Type		
properties	isRef 0 content simple		
facets	Kind pattern	Value [1-9]{1}[0-9]*	annotation
	enumeration 1	documentation <![CDATA[Periodo di imposta che inizia dalla data di messa in liquidazione per cessazione di attività, per fallimento o per liquidazione coatta amministrativa]]>	
	enumeration 2	documentation <![CDATA[Periodi di imposta successivi a quello di dichiarazione di fallimento o di messa in liquidazione]]>	
	enumeration 3	documentation <![CDATA[Periodo d'imposta in cui ha avuto termine la liquidazione per cessazione di attività, per fallimento o per liquidazione coatta amministrativa]]>	
	enumeration 4	documentation <![CDATA[Periodo di imposta in cui si è verificata l'estinzione del soggetto per fusione o incorporazione]]>	
	enumeration 5	documentation <![CDATA[Periodo d'imposta in cui è avvenuta la trasformazione da società soggetta ad IRES in società non soggetta ad IRES o viceversa]]>	
	enumeration 6	documentation <![CDATA[Periodo normale d'imposta e periodo compreso tra l'inizio del periodo d'imposta e la data di messa in liquidazione]]>	
	enumeration 7	documentation <![CDATA[Periodo d'imposta in cui si è verificata l'estinzione del soggetto per scissione totale]]>	
source	<code><xs:element name="Situazione" type="Situazione_Type"/></code>		

complexType **Soggetti_Non_Residenti_Type**

diagram	
namespace	urn:www.agenziaentrate.gov.it:specificheTecniche:sco:common:v2
children	StatoEsteroResidenza CodiceStatoEestero CodicIdentificazioneEestero
source	<pre><xs:complexType name="Soggetti_Non_Residenti_Type"> <xs:sequence> <xs:element name="StatoEsteroResidenza" type="cm:DatoAN_Type" minOccurs="0"/> <xs:element name="CodiceStatoEestero" type="cm:DatoAN_Type" minOccurs="0"/> <xs:element name="CodicIdentificazioneEestero" type="cm:DatoAN_Type" minOccurs="0"/> </xs:sequence> </xs:complexType></pre>

element **Soggetti_Non_Residenti_Type/StatoEsteroResidenza**

diagram	
namespace	urn:www.agenziaentrate.gov.it:specificheTecniche:sco:common:v2
type	DatoAN_Type
properties	isRef 0 minOcc 0 maxOcc 1 content simple
facets	Kind Value annotation pattern [0-9A-Z-]{1}([0-9A-Z] \. \& _ s / ° ^\ ())*
source	<pre><xs:element name="StatoEsteroResidenza" type="cm:DatoAN_Type" minOccurs="0"/></pre>

element **Soggetti_Non_Residenti_Type/CodiceStatoEestero**

diagram	
namespace	urn:www.agenziaentrate.gov.it:specificheTecniche:sco:common:v2
type	DatoAN_Type
properties	isRef 0 minOcc 0 maxOcc 1 content simple
facets	Kind Value annotation pattern [0-9A-Z-]{1}([0-9A-Z] \. \& _ s / ° ^\ ())*

source	<code><xs:element name="CodiceStatoEstero" type="cm:DatoAN_Type" minOccurs="0"/></code>
--------	---

element **Soggetti_Non_Residenti_Type/CodiceIdentificazioneEstero**

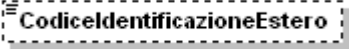
diagram	
namespace	urn:www.agenziaentrate.gov.it:specificheTecniche:sco:common:v2
type	DatoAN_Type
properties	isRef 0 minOcc 0 maxOcc 1 content simple
facets	Kind Value annotation pattern [0-9A-Z]{1}([0-9A-Z] \- \. & , s / ^\(\))*
source	<code><xs:element name="CodiceIdentificazioneEstero" type="cm:DatoAN_Type" minOccurs="0"/></code>

complexType **Soggetto_Fiscale_Type**

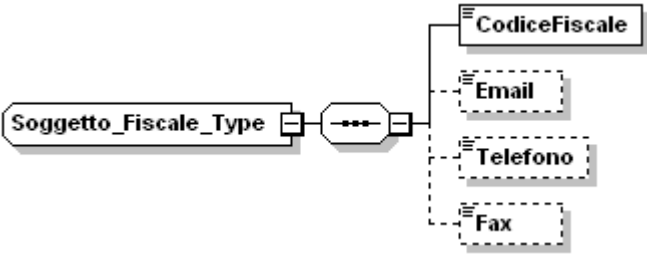
diagram	
namespace	urn:www.agenziaentrate.gov.it:specificheTecniche:sco:common:v2
children	CodiceFiscale Email Telefono Fax
used by	element Frontespizio_Type/SoggettoFiscale
source	<pre><xs:complexType name="Soggetto_Fiscale_Type"> <xs:sequence> <xs:element name="CodiceFiscale" type="cm:DatoCF_Type"/> <xs:element name="Email" type="cm:DatoEM_Type" minOccurs="0"/> <xs:element name="Telefono" type="cm:DatoTL_Type" minOccurs="0"/> <xs:element name="Fax" type="cm:DatoTL_Type" minOccurs="0"/> </xs:sequence> </xs:complexType></pre>

element **Soggetto_Fiscale_Type/CodiceFiscale**

diagram	
namespace	urn:www.agenziaentrate.gov.it:specificheTecniche:sco:common:v2
type	DatoCF_Type
properties	isRef 0 content simple
facets	Kind Value annotation pattern [0-9]{11}[A-Z]{6}[0-9LMNPQRSTUVWXYZ]{2}[A-Z]{1}[0-9LMNPQRSTUVWXYZ]{2}[A-Z]{1}[0-9LMNPQRSTUVWXYZ]{3}[A-Z]{1}
source	<pre><xs:element name="CodiceFiscale" type="cm:DatoCF_Type"/></pre>

element **Soggetto_Fiscale_Type/Email**

diagram	
namespace	urn:www.agenziaentrate.gov.it:specificheTecniche:sco:common:v2
type	DatoEM_Type
properties	isRef 0 minOcc 0 maxOcc 1 content simple
facets	Kind Value annotation pattern [a-zA-Z0-9._%~]+@[a-zA-Z0-9.\-]+\.[a-zA-Z]{2,4}
source	<pre><xs:element name="Email" type="cm:DatoEM_Type" minOccurs="0"/></pre>

element **Soggetto_Fiscale_Type/Telefono**

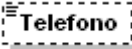
diagram	
namespace	urn:www.agenziaentrate.gov.it:specificheTecniche:sco:common:v2
type	DatoTL_Type
properties	isRef 0 minOcc 0 maxOcc 1 content simple
facets	Kind Value annotation pattern [0-9]*
source	<pre><xs:element name="Telefono" type="cm:DatoTL_Type" minOccurs="0"/></pre>

element **Soggetto_Fiscale_Type/Fax**

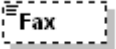
diagram	
namespace	urn:www.agenziaentrate.gov.it:specificheTecniche:sco:common:v2

type	DatoTL_Type
properties	isRef 0 minOcc 0 maxOcc 1 content simple
facets	Kind Value annotation pattern [0-9]*
source	<code><xs:element name="Fax" type="cm:DatoTL_Type" minOccurs="0"/></code>

complexType Tipo_Dichiarazione_Type

diagram	
namespace	urn:www.agenziaentrate.gov.it:specificheTecniche:sco:common:v2
children	Correttiva IntegrativaAFavore Integrativa IntegrativaArt2Co8Ter
source	<pre> <xs:complexType name="Tipo_Dichiarazione_Type"> <xs:choice> <xs:element name="Correttiva" type="cm:DatoCB_Type"/> <xs:element name="IntegrativaAFavore" type="cm:DatoCB_Type"/> <xs:element name="Integrativa" type="cm:DatoCB_Type"/> <xs:element name="IntegrativaArt2Co8Ter" type="cm:DatoCB_Type"/> </xs:choice> </xs:complexType> </pre>

element Tipo_Dichiarazione_Type/Correttiva

diagram	
namespace	urn:www.agenziaentrate.gov.it:specificheTecniche:sco:common:v2
type	DatoCB_Type
properties	isRef 0 content simple
facets	Kind Value annotation pattern [01]
source	<code><xs:element name="Correttiva" type="cm:DatoCB_Type"/></code>

element Tipo_Dichiarazione_Type/IntegrativaAFavore

diagram	
namespace	urn:www.agenziaentrate.gov.it:specificheTecniche:sco:common:v2
type	DatoCB_Type
properties	isRef 0 content simple
facets	Kind Value annotation pattern [01]
source	<code><xs:element name="IntegrativaAFavore" type="cm:DatoCB_Type"/></code>

element Tipo_Dichiarazione_Type/Integrativa

diagram	
namespace	urn:www.agenziaentrate.gov.it:specificheTecniche:sco:common:v2
type	DatoCB_Type
properties	isRef 0 content simple
facets	Kind Value annotation pattern [01]
source	<code><xs:element name="Integrativa" type="cm:DatoCB_Type"/></code>

element Tipo_Dichiarazione_Type/IntegrativaArt2Co8Ter

diagram	
namespace	urn:www.agenziaentrate.gov.it:specificheTecniche:sco:common:v2
type	DatoCB_Type
properties	isRef 0 content simple
facets	Kind Value annotation pattern [01]
source	<code><xs:element name="IntegrativaArt2Co8Ter" type="cm:DatoCB_Type"/></code>

complexType Visto_Conformita_Type

diagram	
namespace	urn:www.agenziaentrate.gov.it:specificheTecniche:sco:common:v2

children	VistoCAF CFprofessionista Firma
source	<pre> <xs:complexType name="Visto_Conformita_Type"> <xs:sequence> <xs:choice> <xs:element name="VistoCAF"> <xs:complexType> <xs:sequence> <xs:element name="CFResp" type="cm:DatoCF_Type"/> <xs:element name="CF_CAF" type="cm:DatoCN_Type"/> </xs:sequence> </xs:complexType> </xs:element> <xs:element name="CFprofessionista" type="cm:DatoCF_Type"/> </xs:choice> <xs:element name="Firma" type="cm:DatoCB_Type"/> </xs:sequence> </xs:complexType> </pre>

element Visto_Conformita_Type/VistoCAF

diagram	<pre> graph LR VistoCAF[VistoCAF] --- Choice((Choice)) Choice --- CFResp[CFResp] Choice --- CF_CAF[CF_CAF] </pre>
namespace	urn:www.agenziaentrate.gov.it:specificheTecniche:sco:common:v2
properties	isRef 0 content complex
children	CFResp CF_CAF
source	<pre> <xs:element name="VistoCAF"> <xs:complexType> <xs:sequence> <xs:element name="CFResp" type="cm:DatoCF_Type"/> <xs:element name="CF_CAF" type="cm:DatoCN_Type"/> </xs:sequence> </xs:complexType> </xs:element> </pre>

element Visto_Conformita_Type/VistoCAF/CFResp

diagram	<pre> graph LR CFResp[CFResp] </pre>
namespace	urn:www.agenziaentrate.gov.it:specificheTecniche:sco:common:v2
type	DatoCF_Type

properties	isRef 0 content simple	
facets	Kind Value pattern [0-9]{11}[A-Z]{6}[0-9LMNPQRSTUVWXYZ]{2}[A-Z]{1}[0-9LMNPQRSTUVWXYZ]{2}[A-Z]{1}[0-9LMNPQRSTUVWXYZ]{3}[A-Z]{1}	annotation
source	<code><xs:element name="CFResp" type="cm:DatoCF_Type"/></code>	

element Visto_Conformita_Type/VistoCAF/CF_CAF

diagram		
namespace	urn:www.agenziaentrate.gov.it:specificheTecniche:sco:common:v2	
type	DatoCN_Type	
properties	isRef 0 content simple	
facets	Kind Value length 11 pattern [0-9]{11}	annotation
source	<code><xs:element name="CF_CAF" type="cm:DatoCN_Type"/></code>	

element Visto_Conformita_Type/CFprofessionista

diagram		
namespace	urn:www.agenziaentrate.gov.it:specificheTecniche:sco:common:v2	
type	DatoCF_Type	
properties	isRef 0 content simple	
facets	Kind Value pattern [0-9]{11}[A-Z]{6}[0-9LMNPQRSTUVWXYZ]{2}[A-Z]{1}[0-9LMNPQRSTUVWXYZ]{2}[A-Z]{1}[0-9LMNPQRSTUVWXYZ]{3}[A-Z]{1}	annotation
source	<code><xs:element name="CFprofessionista" type="cm:DatoCF_Type"/></code>	

element Visto_Conformita_Type/Firma

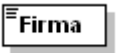
diagram		
namespace	urn:www.agenziaentrate.gov.it:specificheTecniche:sco:common:v2	
type	DatoCB_Type	
properties	isRef 0 content simple	
facets	Kind Value pattern [01]	annotation
source	<code><xs:element name="Firma" type="cm:DatoCB_Type"/></code>	

element Fornitura

diagram	
namespace	urn:www.agenziaentrate.gov.it:specificheTecniche:sco:sce:v1
properties	content complex
children	sce:Intestazione sce:Documento
source	<pre> <xs:element name="Fornitura"> <xs:complexType> <xs:sequence> <xs:element name="Intestazione"> <xs:complexType> <xs:complexContent> <xs:extension base="cm:Dati_Intestazione_Type"> <xs:sequence> <xs:element name="CodiceFornitura"> <xs:simpleType> <xs:restriction base="cm:CodiceFornitura_Type"> <xs:enumeration value="SCE12"/> <xs:enumeration value="SCS12"/> </xs:restriction> </xs:simpleType> </xs:element> <xs:element name="TipoFornitore"> <xs:simpleType> <xs:restriction base="cm:DatoAN_Type"> <xs:enumeration value="1"/> <xs:enumeration value="3"/> <xs:enumeration value="5"/> <xs:enumeration value="7"/> <xs:enumeration value="10"/> </xs:restriction> </xs:simpleType> </xs:element> <xs:element name="UfficioPerifericoCAF" minOccurs="0"> <xs:complexType> <xs:sequence> <xs:element name="Comune" minOccurs="0"/> <xs:element name="Provincia" type="cm:PR_Type" minOccurs="0"/> <xs:element name="CodiceComune" </pre>

```

type="cm:DatoAN_Type" minOccurs="0"/>
    <xs:element name="Indirizzo"
type="cm:DatoAN_Type" minOccurs="0"/>
    <xs:element name="Cap"
type="cm:DatoCP_Type" minOccurs="0"/>
    </xs:sequence>
    </xs:complexType>
    </xs:element>
  </xs:sequence>
  </xs:extension>
</xs:complexContent>
</xs:complexType>
</xs:element>
<xs:element name="Documento" maxOccurs="unbounded">
  <xs:complexType>
    <xs:complexContent>
      <xs:extension base="sce:Documento_SCE_Type"/>
    </xs:complexContent>
  </xs:complexType>
</xs:element>
</xs:sequence>
</xs:complexType>
</xs:element>

```

element Fornitura/Intestazione

diagram	
namespace	urn:www.agenziaentrate.gov.it:specificheTecniche:sco:sce:v1
type	extension of Dati_Intestazione_Type
properties	isRef 0 content complex
children	CodiceFiscaleFornitore SpazioUtente SpazioServizioTelematico sce:CodiceFornitura sce:TipoFornitore sce:UfficioPerifericoCAF

source

```
<xs:element name="Intestazione">
  <xs:complexType>
    <xs:complexContent>
      <xs:extension base="cm:Dati_Intestazione_Type">
        <xs:sequence>
          <xs:element name="CodiceFornitura">
            <xs:simpleType>
              <xs:restriction base="cm:CodiceFornitura_Type">
                <xs:enumeration value="SCE12"/>
                <xs:enumeration value="SCS12"/>
              </xs:restriction>
            </xs:simpleType>
          </xs:element>
          <xs:element name="TipoFornitore">
            <xs:simpleType>
              <xs:restriction base="cm:DatoAN_Type">
                <xs:enumeration value="1"/>
                <xs:enumeration value="3"/>
                <xs:enumeration value="5"/>
                <xs:enumeration value="7"/>
                <xs:enumeration value="10"/>
              </xs:restriction>
            </xs:simpleType>
          </xs:element>
          <xs:element name="UfficioPerifericoCAF"
minOccurs="0">
            <xs:complexType>
              <xs:sequence>
                <xs:element name="Comune" minOccurs="0"/>
                <xs:element name="Provincia"
type="cm:PR_Type" minOccurs="0"/>
                <xs:element name="CodiceComune"
type="cm:DatoAN_Type" minOccurs="0"/>
                <xs:element name="Indirizzo"
type="cm:DatoAN_Type" minOccurs="0"/>
                <xs:element name="Cap" type="cm:DatoCP_Type"
minOccurs="0"/>
              </xs:sequence>
            </xs:complexType>
          </xs:element>
        </xs:sequence>
      </xs:extension>
    </xs:complexContent>
  </xs:complexType>
</xs:element>
```

element Fornitura/Intestazione/CodiceFornitura

diagram	
namespace	urn:www.agenziaentrate.gov.it:specificheTecniche:sco:sce:v1
type	restriction of CodiceFornitura_Type
properties	isRef 0 content simple
facets	Kind Value annotation length 5 pattern [0-9A-Z-]{1}([0-9A-Z] \\- \\. & ; \\s / ° \\^ \\(\\))* enumeration SCE12 enumeration SCS12
source	<pre><xs:element name="CodiceFornitura"> <xs:simpleType> <xs:restriction base="cm:CodiceFornitura_Type"> <xs:enumeration value="SCE12"/> <xs:enumeration value="SCS12"/> </xs:restriction> </xs:simpleType> </xs:element></pre>

element Fornitura/Intestazione/TipoFornitore

diagram	
namespace	urn:www.agenziaentrate.gov.it:specificheTecniche:sco:sce:v1
type	restriction of DatoAN_Type
properties	isRef 0 content simple
facets	Kind Value annotation pattern [0-9A-Z-]{1}([0-9A-Z] \\- \\. & ; \\s / ° \\^ \\(\\))* enumeration 1 enumeration 3 enumeration 5 enumeration 7 enumeration 10
source	<pre><xs:element name="TipoFornitore"> <xs:simpleType> <xs:restriction base="cm:DatoAN_Type"> <xs:enumeration value="1"/> <xs:enumeration value="3"/> <xs:enumeration value="5"/> <xs:enumeration value="7"/> <xs:enumeration value="10"/> </xs:restriction> </xs:simpleType> </xs:element></pre>

	<code></xs:element></code>
--	----------------------------------

element Fornitura/Intestazione/UfficioPerifericoCAF

diagram	
namespace	urn:www.agenziaentrate.gov.it:specificheTecniche:sco:sce:v1
properties	isRef 0 minOcc 0 maxOcc 1 content complex
children	sce:Comune sce:Provincia sce:CodiceComune sce:Indirizzo sce:Cap
source	<pre><xs:element name="UfficioPerifericoCAF" minOccurs="0"> <xs:complexType> <xs:sequence> <xs:element name="Comune" minOccurs="0"/> <xs:element name="Provincia" type="cm:PR_Type" minOccurs="0"/> <xs:element name="CodiceComune" type="cm:DatoAN_Type" minOccurs="0"/> <xs:element name="Indirizzo" type="cm:DatoAN_Type" minOccurs="0"/> <xs:element name="Cap" type="cm:DatoCP_Type" minOccurs="0"/> </xs:sequence> </xs:complexType> </xs:element></pre>

element Fornitura/Intestazione/UfficioPerifericoCAF/Comune

diagram	
namespace	urn:www.agenziaentrate.gov.it:specificheTecniche:sco:sce:v1
properties	isRef 0 minOcc 0 maxOcc 1
source	<pre><xs:element name="Comune" minOccurs="0"/></pre>

element **Fornitura/Intestazione/UfficioPerifericoCAF/Provincia**

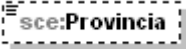
diagram	
namespace	urn:www.agenziaentrate.gov.it:specificheTecniche:sco:sce:v1
type	PR_Type
properties	isRef 0 minOcc 0 maxOcc 1 content simple
source	<pre><xs:element name="Provincia" type="cm:PR_Type" minOccurs="0"/></pre>

element **Fornitura/Intestazione/UfficioPerifericoCAF/CodiceComune**

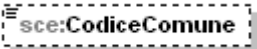
diagram	
namespace	urn:www.agenziaentrate.gov.it:specificheTecniche:sco:sce:v1
type	DatoAN_Type
properties	isRef 0 minOcc 0 maxOcc 1 content simple
facets	Kind Value annotation pattern [0-9A-Z-]{1}([0-9A-Z] \. \& _ ! @ \^ \(\))*
source	<pre><xs:element name="CodiceComune" type="cm:DatoAN_Type" minOccurs="0"/></pre>

element **Fornitura/Intestazione/UfficioPerifericoCAF/Indirizzo**

diagram	
namespace	urn:www.agenziaentrate.gov.it:specificheTecniche:sco:sce:v1
type	DatoAN_Type
properties	isRef 0 minOcc 0 maxOcc 1 content simple
facets	Kind Value annotation pattern [0-9A-Z-]{1}([0-9A-Z] \. \& _ ! @ \^ \(\))*
source	<pre><xs:element name="Indirizzo" type="cm:DatoAN_Type" minOccurs="0"/></pre>

element **Fornitura/Intestazione/UfficioPerifericoCAF/Cap**

diagram	
---------	---

namespace	urn:www.agenziaentrate.gov.it:specificheTecniche:sco:sce:v1
type	DatoCP_Type
properties	isRef 0 minOcc 0 maxOcc 1 content simple
facets	Kind Value annotation pattern [0-9]{5}
source	<code><xs:element name="Cap" type="cm:DatoCP_Type" minOccurs="0"/></code>

element Fornitura/Documento

diagram													
namespace	urn:www.agenziaentrate.gov.it:specificheTecniche:sco:sce:v1												
type	extension of sce:Documento_SCE_Type												
properties	isRef 0 minOcc 1 maxOcc unbounded content complex												
children	sce:BustaVuota sce:CfBusta sce:DichiarazioneDichiarante sce:DichiarazioneConiuge sce:BanchePoste												
attributes	<table border="1"> <thead> <tr> <th>Name</th> <th>Type</th> <th>Use</th> <th>Default</th> <th>Fixed</th> <th>annotation</th> </tr> </thead> <tbody> <tr> <td>identificativo</td> <td>Identificativo_Type</td> <td>required</td> <td></td> <td></td> <td></td> </tr> </tbody> </table>	Name	Type	Use	Default	Fixed	annotation	identificativo	Identificativo_Type	required			
Name	Type	Use	Default	Fixed	annotation								
identificativo	Identificativo_Type	required											
source	<pre> <xs:element name="Documento" maxOccurs="unbounded"> <xs:complexType> <xs:complexContent> <xs:extension base="sce:Documento_SCE_Type"/> </xs:complexContent> </xs:complexType> </xs:element> </pre>												

complexType **DatiAnagraficiScelte_Type**

diagram	
namespace	urn:www.agenziaentrate.gov.it:specificheTecniche:sco:sce:v1
children	sce:Cognome sce:Nome sce:Sesso sce:DataNascita sce:ComuneNascita sce:ProvinciaNascita
used by	element Frontespizio_SCE_Type/DatiAnagrafici
source	<pre> <xs:complexType name="DatiAnagraficiScelte_Type"> <xs:sequence> <xs:element name="Cognome" type="cm:DatoAN_Type" minOccurs="0"/> <xs:element name="Nome" type="cm:DatoAN_Type" minOccurs="0"/> <xs:element name="Sesso" type="sc:Sesso_Type" minOccurs="0"/> <xs:element name="DataNascita" type="cm:DatoDT_Type" minOccurs="0"/> <xs:element name="ComuneNascita" type="cm:DatoAN_Type" minOccurs="0"/> <xs:element name="ProvinciaNascita" type="cm:PN_Type" minOccurs="0"/> </xs:sequence> </xs:complexType> </pre>

element **DatiAnagraficiScelte_Type/Cognome**

diagram									
namespace	urn:www.agenziaentrate.gov.it:specificheTecniche:sco:sce:v1								
type	DatoAN_Type								
properties	<table border="0"> <tr><td>isRef</td><td>0</td></tr> <tr><td>minOcc</td><td>0</td></tr> <tr><td>maxOcc</td><td>1</td></tr> <tr><td>content</td><td>simple</td></tr> </table>	isRef	0	minOcc	0	maxOcc	1	content	simple
isRef	0								
minOcc	0								
maxOcc	1								
content	simple								
facets	<table border="0"> <tr> <td>Kind</td> <td>Value</td> <td>annotation</td> </tr> <tr> <td>pattern</td> <td>[0-9A-Z-]{1}([0-9A-Z] \. \& _ ! @ \^ \v \l)*)</td> <td></td> </tr> </table>	Kind	Value	annotation	pattern	[0-9A-Z-]{1}([0-9A-Z] \. \& _ ! @ \^ \v \l)*)			
Kind	Value	annotation							
pattern	[0-9A-Z-]{1}([0-9A-Z] \. \& _ ! @ \^ \v \l)*)								
source	<pre> <xs:element name="Cognome" type="cm:DatoAN_Type" </pre>								

source	<pre><xs:element name="DataNascita" type="cm:DatoDT_Type" minOccurs="0"/></pre>
--------	---

element DatiAnagraficiScelte_Type/ComuneNascita

diagram	
namespace	urn:www.agenziaentrate.gov.it:specificheTecniche:sco:sce:v1
type	DatoAN_Type
properties	isRef 0 minOcc 0 maxOcc 1 content simple
facets	Kind Value annotation pattern [0-9A-Z-]{1}([0-9A-Z] \\- \\. ‑ \\s / ^\\(\\))*
source	<pre><xs:element name="ComuneNascita" type="cm:DatoAN_Type" minOccurs="0"/></pre>

element DatiAnagraficiScelte_Type/ProvinciaNascita

diagram	
namespace	urn:www.agenziaentrate.gov.it:specificheTecniche:sco:sce:v1
type	PN_Type
properties	isRef 0 minOcc 0 maxOcc 1 content simple
source	<pre><xs:element name="ProvinciaNascita" type="cm:PN_Type" minOccurs="0"/></pre>

complexType Dichiarazione_SCE_Type

diagram	
namespace	urn:www.agenziaentrate.gov.it:specificheTecniche:sco:sce:v1
children	sce:FlagAnomaliaCFAnag sce:Frontespizio
used by	elements Documento_SCE_Type/DichiarazioneConiuge Documento_SCE_Type/DichiarazioneDichiarante
source	<pre><xs:complexType name="Dichiarazione_SCE_Type"> <xs:sequence> <xs:element name="FlagAnomaliaCFAnag" type="cm:DatoCB_Type" minOccurs="0"/> <xs:element name="Frontespizio" type="cm:DatoCB_Type" minOccurs="0"/> </xs:sequence> </xs:complexType></pre>

	<pre> type="sce:Frontespizio_SCE_Type"/> </xs:sequence> </xs:complexType> </pre>
--	---

element Dichiarazione_SCE_Type/FlagAnomaliaCFAnag

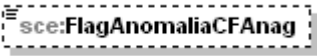
diagram	
namespace	urn:www.agenziaentrate.gov.it:specificheTecniche:sco:sce:v1
type	DatoCB_Type
properties	isRef 0 minOcc 0 maxOcc 1 content simple
facets	Kind Value annotation pattern [01]
source	<pre> <xs:element name="FlagAnomaliaCFAnag" type="cm:DatoCB_Type" minOccurs="0"/> </pre>

element Dichiarazione_SCE_Type/Frontespizio

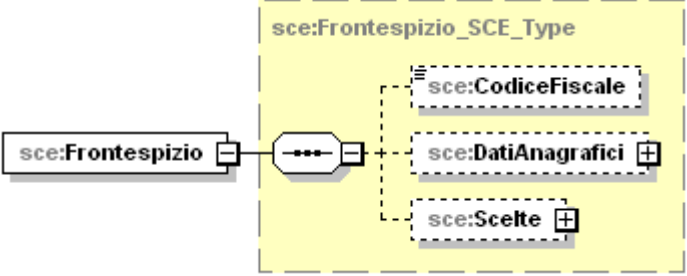
diagram	
namespace	urn:www.agenziaentrate.gov.it:specificheTecniche:sco:sce:v1
type	sce:Frontespizio_SCE_Type
properties	isRef 0 content complex
children	sce:CodiceFiscale sce:DatiAnagrafici sce:Scelte
source	<pre> <xs:element name="Frontespizio" type="sce:Frontespizio_SCE_Type"/> </pre>

complexType Documento_SCE_Type

diagram													
namespace	urn:www.agenziaentrate.gov.it:specificheTecniche:sco:sce:v1												
type	extension of Documento_Type												
properties	base cm:Documento_Type												
children	sce:BustaVuota sce:CfBusta sce:DichiarazioneDichiarante sce:DichiarazioneConiuge sce:BanchePoste												
used by	element Fornitura/Documento												
attributes	<table border="1"> <thead> <tr> <th>Name</th> <th>Type</th> <th>Use</th> <th>Default</th> <th>Fixed</th> <th>annotation</th> </tr> </thead> <tbody> <tr> <td>identificativo</td> <td>Identificativo_Type</td> <td>required</td> <td></td> <td></td> <td></td> </tr> </tbody> </table>	Name	Type	Use	Default	Fixed	annotation	identificativo	Identificativo_Type	required			
Name	Type	Use	Default	Fixed	annotation								
identificativo	Identificativo_Type	required											
source	<pre> <xs:complexType name="Documento_SCE_Type"> <xs:complexContent> <xs:extension base="cm:Documento_Type"> <xs:sequence> <xs:element name="BustaVuota" type="cm:DatoCB_Type" minOccurs="0"/> <xs:element name="CfBusta" type="cm:DatoAN_Type" minOccurs="0"/> <xs:element name="DichiarazioneDichiarante" type="sce:Dichiarazione_SCE_Type"/> <xs:element name="DichiarazioneConiuge" type="sce:Dichiarazione_SCE_Type" minOccurs="0"/> <xs:element name="BanchePoste" minOccurs="0"> <xs:complexType> <xs:sequence> <xs:element name="NumProgPacco" minOccurs="0"> <xs:simpleType> <xs:restriction base="cm:DatoNP_Type"> <xs:maxLength value="7"/> </xs:restriction> </xs:simpleType> </xs:element> </xs:sequence> </xs:complexType> </xs:element> </xs:sequence> </xs:extension> </xs:complexContent> </xs:complexType> </pre>												

```

<xs:element name="NumSeqDicIntPacco"
minOccurs="0">
  <xs:simpleType>
    <xs:restriction base="cm:DatoNP_Type">
      <xs:maxLength value="3"/>
    </xs:restriction>
  </xs:simpleType>
</xs:element>
<xs:element name="CodCentroOperativo"
minOccurs="0">
  <xs:simpleType>
    <xs:restriction base="cm:DatoAN_Type">
      <xs:maxLength value="1"/>
    </xs:restriction>
  </xs:simpleType>
</xs:element>
<xs:element name="FormatoErrato"
type="cm:DatoCB_Type" minOccurs="0"/>
<xs:element name="ProtIDmodErrato"
type="cm:DatoCB_Type" minOccurs="0"/>
<xs:element name="NumeroProtocollo">
  <xs:simpleType>
    <xs:restriction base="cm:DatoAN_Type">
      <xs:maxLength value="25"/>
      <xs:minLength value="18"/>
    </xs:restriction>
  </xs:simpleType>
</xs:element>
</xs:sequence>
</xs:complexType>
</xs:element>
</xs:sequence>
</xs:extension>
</xs:complexContent>
</xs:complexType>

```

element Documento_SCE_Type/BustaVuota

diagram									
namespace	urn:www.agenziaentrate.gov.it:specificheTecniche:sco:sce:v1								
type	DatoCB_Type								
properties	<table border="0"> <tr><td>isRef</td><td>0</td></tr> <tr><td>minOcc</td><td>0</td></tr> <tr><td>maxOcc</td><td>1</td></tr> <tr><td>content</td><td>simple</td></tr> </table>	isRef	0	minOcc	0	maxOcc	1	content	simple
isRef	0								
minOcc	0								
maxOcc	1								
content	simple								
facets	<table border="0"> <tr><td>Kind</td><td>Value</td><td>annotation</td></tr> </table>	Kind	Value	annotation					
Kind	Value	annotation							

	pattern [01]
source	<code><xs:element name="BustaVuota" type="cm:DatoCB_Type" minOccurs="0"/></code>

element Documento_SCE_Type/CfBusta

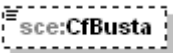
diagram	
namespace	urn:www.agenziaentrate.gov.it:specificheTecniche:sco:sce:v1
type	DatoAN_Type
properties	isRef 0 minOcc 0 maxOcc 1 content simple
facets	Kind Value annotation pattern [0-9A-Z-]{1}([0-9A-Z] \. \& , \/ ° °\ \(\))*
source	<code><xs:element name="CfBusta" type="cm:DatoAN_Type" minOccurs="0"/></code>

element Documento_SCE_Type/DichiarazioneDichiarante

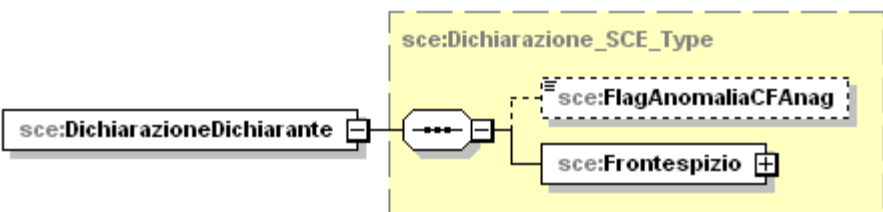
diagram	
namespace	urn:www.agenziaentrate.gov.it:specificheTecniche:sco:sce:v1
type	sce:Dichiarazione_SCE_Type
properties	isRef 0 content complex
children	sce:FlagAnomaliaCFAnag sce:Frontespizio
source	<code><xs:element name="DichiarazioneDichiarante" type="sce:Dichiarazione_SCE_Type"/></code>

element Documento_SCE_Type/DichiarazioneConiuge

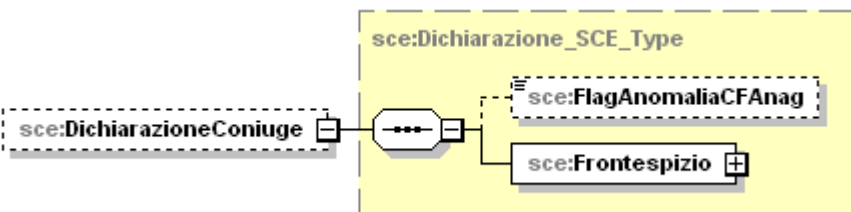
diagram	
namespace	urn:www.agenziaentrate.gov.it:specificheTecniche:sco:sce:v1

type	sce:Dichiarazione SCE Type
properties	isRef 0 minOcc 0 maxOcc 1 content complex
children	sce:FlagAnomaliaCFAna sce:Frontespizio
source	<pre><xs:element name="DichiarazioneConiuge" type="sce:Dichiarazione_SCE_Type" minOccurs="0"/></pre>

element Documento_SCE_Type/BanchePoste

diagram	
namespace	urn:www.agenziaentrate.gov.it:specificheTecniche:sco:sce:v1
properties	isRef 0 minOcc 0 maxOcc 1 content complex
children	sce:NumProgPacco sce:NumSeqDicIntPacco sce:CodCentroOperativo sce:FormatoErrato sce:ProtIDmodErrato sce:NumeroProtocollo
source	<pre><xs:element name="BanchePoste" minOccurs="0"> <xs:complexType> <xs:sequence> <xs:element name="NumProgPacco" minOccurs="0"> <xs:simpleType> <xs:restriction base="cm:DatoNP_Type"> <xs:maxLength value="7"/> </xs:restriction> </xs:simpleType> </xs:element> <xs:element name="NumSeqDicIntPacco" minOccurs="0"> <xs:simpleType> <xs:restriction base="cm:DatoNP_Type"> <xs:maxLength value="3"/> </xs:restriction> </xs:simpleType> </xs:element> <xs:element name="CodCentroOperativo" minOccurs="0"> <xs:simpleType> </pre>

	<pre> <xs:restriction base="cm:DatoAN_Type"> <xs:maxLength value="1"/> </xs:restriction> </xs:simpleType> </xs:element> <xs:element name="FormatoErrato" type="cm:DatoCB_Type" minOccurs="0"/> <xs:element name="ProtIDmodErrato" type="cm:DatoCB_Type" minOccurs="0"/> <xs:element name="NumeroProtocollo"> <xs:simpleType> <xs:restriction base="cm:DatoAN_Type"> <xs:maxLength value="25"/> <xs:minLength value="18"/> </xs:restriction> </xs:simpleType> </xs:element> </xs:sequence> </xs:complexType> </xs:element> </pre>
--	--

element Documento_SCE_Type/BanchePoste/NumProgPacco

diagram										
namespace	urn:www.agenziaentrate.gov.it:specificheTecniche:sco:sce:v1									
type	restriction of DatoNP_Type									
properties	<table border="0"> <tr><td>isRef</td><td>0</td></tr> <tr><td>minOcc</td><td>0</td></tr> <tr><td>maxOcc</td><td>1</td></tr> <tr><td>content</td><td>simple</td></tr> </table>	isRef	0	minOcc	0	maxOcc	1	content	simple	
isRef	0									
minOcc	0									
maxOcc	1									
content	simple									
facets	<table border="0"> <tr><td>Kind</td><td>Value</td><td>annotation</td></tr> <tr><td>maxLength</td><td>7</td><td></td></tr> <tr><td>pattern</td><td>[1-9]{1}[0-9]*</td><td></td></tr> </table>	Kind	Value	annotation	maxLength	7		pattern	[1-9]{1}[0-9]*	
Kind	Value	annotation								
maxLength	7									
pattern	[1-9]{1}[0-9]*									
source	<pre> <xs:element name="NumProgPacco" minOccurs="0"> <xs:simpleType> <xs:restriction base="cm:DatoNP_Type"> <xs:maxLength value="7"/> </xs:restriction> </xs:simpleType> </xs:element> </pre>									

element Documento_SCE_Type/BanchePoste/NumSeqDicIntPacco

diagram	
---------	---

namespace	urn:www.agenziaentrate.gov.it:specificheTecniche:sco:sce:v1
type	restriction of DatoNP_Type
properties	isRef 0 minOcc 0 maxOcc 1 content simple
facets	Kind Value annotation maxLength 3 pattern [1-9]{1}[0-9]*
source	<pre><xs:element name="NumSeqDicIntPacco" minOccurs="0"> <xs:simpleType> <xs:restriction base="cm:DatoNP_Type"> <xs:maxLength value="3"/> </xs:restriction> </xs:simpleType> </xs:element></pre>

element Documento_SCE_Type/BanchePoste/CodCentroOperativo

diagram	
namespace	urn:www.agenziaentrate.gov.it:specificheTecniche:sco:sce:v1
type	restriction of DatoAN_Type
properties	isRef 0 minOcc 0 maxOcc 1 content simple
facets	Kind Value annotation maxLength 1 pattern [0-9A-Z]{1}([0-9A-Z] [-\.\' _ / \ \\])*
source	<pre><xs:element name="CodCentroOperativo" minOccurs="0"> <xs:simpleType> <xs:restriction base="cm:DatoAN_Type"> <xs:maxLength value="1"/> </xs:restriction> </xs:simpleType> </xs:element></pre>

element Documento_SCE_Type/BanchePoste/FormatoErrato

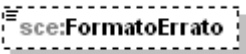
diagram	
namespace	urn:www.agenziaentrate.gov.it:specificheTecniche:sco:sce:v1
type	DatoCB_Type
properties	isRef 0 minOcc 0 maxOcc 1 content simple

facets	Kind Value annotation pattern [01]
source	<code><xs:element name="FormatoErrato" type="cm:DatoCB_Type" minOccurs="0"/></code>

element Documento_SCE_Type/BanchePoste/ProtIDmodErrato

diagram	
namespace	urn:www.agenziaentrate.gov.it:specificheTecniche:sco:sce:v1
type	DatoCB_Type
properties	isRef 0 minOcc 0 maxOcc 1 content simple
facets	Kind Value annotation pattern [01]
source	<code><xs:element name="ProtIDmodErrato" type="cm:DatoCB_Type" minOccurs="0"/></code>

element Documento_SCE_Type/BanchePoste/NumeroProtocollo

diagram	
namespace	urn:www.agenziaentrate.gov.it:specificheTecniche:sco:sce:v1
type	restriction of DatoAN_Type
properties	isRef 0 content simple
facets	Kind Value annotation minLength 18 maxLength 25 pattern [0-9A-Z-]{1}([0-9A-Z] - \. & , s / ° \\ ())*
source	<pre><xs:element name="NumeroProtocollo"> <xs:simpleType> <xs:restriction base="cm:DatoAN_Type"> <xs:maxLength value="25"/> <xs:minLength value="18"/> </xs:restriction> </xs:simpleType> </xs:element></pre>

complexType Frontespizio_SCE_Type

diagram	
namespace	urn:www.agenziaentrate.gov.it:specificheTecniche:sco:sce:v1
children	sce:CodiceFiscale sce:DatiAnagrafici sce:Scelte
used by	element Dichiarazione_SCE_Type/Frontespizio
source	<pre> <xs:complexType name="Frontespizio_SCE_Type"> <xs:sequence> <xs:element name="CodiceFiscale" type="cm:DatoAN_Type" minOccurs="0"/> <xs:element name="DatiAnagrafici" type="sce:DatiAnagraficiScelte_Type" minOccurs="0"/> <xs:element name="Scelte" minOccurs="0"> <xs:complexType> <xs:choice> <xs:sequence> <xs:element name="Scelta5PerMille" type="sce:Scelta5PerMille_Type" minOccurs="0"/> <xs:element name="Scelta8PerMille" type="sce:Scelta8PerMille_Type" minOccurs="0"/> </xs:sequence> <xs:element name="CryptedScelte" type="xs:base64Binary"/> </xs:choice> </xs:complexType> </xs:element> </xs:sequence> </xs:complexType> </pre>

element Frontespizio_SCE_Type/CodiceFiscale

diagram	
namespace	urn:www.agenziaentrate.gov.it:specificheTecniche:sco:sce:v1
type	DatoAN_Type
properties	isRef 0 minOcc 0 maxOcc 1 content simple
facets	Kind Value annotation pattern [0-9A-Z-]{1}([0-9A-Z] ' \. \& , \/ ° ^\(\))*)
source	<pre><xs:element name="CodiceFiscale" type="cm:DatoAN_Type"></pre>

	<code>minOccurs="0"/></code>
--	---------------------------------

element **Frontespizio_SCE_Type/DatiAnagrafici**

diagram									
namespace	urn:www.agenziaentrate.gov.it:specificheTecniche:sco:sce:v1								
type	sce:DatiAnagraficiScelte_Type								
properties	<table border="0"> <tr><td>isRef</td><td>0</td></tr> <tr><td>minOcc</td><td>0</td></tr> <tr><td>maxOcc</td><td>1</td></tr> <tr><td>content</td><td>complex</td></tr> </table>	isRef	0	minOcc	0	maxOcc	1	content	complex
isRef	0								
minOcc	0								
maxOcc	1								
content	complex								
children	sce:Cognome sce:Nome sce:Sesso sce:DataNascita sce:ComuneNascita sce:ProvinciaNascita								
source	<code><xs:element name="DatiAnagrafici" type="sce:DatiAnagraficiScelte_Type" minOccurs="0"/></code>								

element **Frontespizio_SCE_Type/Scelte**

diagram									
namespace	urn:www.agenziaentrate.gov.it:specificheTecniche:sco:sce:v1								
properties	<table border="0"> <tr><td>isRef</td><td>0</td></tr> <tr><td>minOcc</td><td>0</td></tr> <tr><td>maxOcc</td><td>1</td></tr> <tr><td>content</td><td>complex</td></tr> </table>	isRef	0	minOcc	0	maxOcc	1	content	complex
isRef	0								
minOcc	0								
maxOcc	1								
content	complex								
children	sce:Scelta5PerMille sce:Scelta8PerMille sce:CryptedScelte								
source	<pre><xs:element name="Scelte" minOccurs="0"> <xs:complexType> <xs:choice> <xs:sequence> <xs:element name="Scelta5PerMille"</pre>								

```

type="sce:Scelta5PerMille_Type" minOccurs="0"/>
  <xs:element name="Scelta8PerMille"
type="sce:Scelta8PerMille_Type" minOccurs="0"/>
  </xs:sequence>
  <xs:element name="CryptedScelte"
type="xs:base64Binary"/>
  </xs:choice>
</xs:complexType>
</xs:element>

```

element **Frontespizio_SCE_Type/Scelte/Scelta5PerMille**

<p>diagram</p>	
<p>namespace</p>	<p>urn:www.agenziaentrate.gov.it:specificheTecniche:sco:sce:v1</p>
<p>type</p>	<p>sce:Scelta5PerMille_Type</p>
<p>properties</p>	<p>isRef 0 minOcc 0 maxOcc 1 content complex</p>
<p>children</p>	<p>sce:SostegnoVolontariatoNonLucrativo sce:RicercaScientifica sce:RicercaSanitaria sce:BeniCulturaliPaesaggistici sce:SostegnoSocialeComune sce:SostegnoAssociazioniSportive sce:SceltaNonEffettuata sce:Anomalia sce:FlagAnomaliaCFbeneficiario</p>
<p>source</p>	<pre> <xs:element name="Scelta5PerMille" type="sce:Scelta5PerMille_Type" minOccurs="0"/> </pre>

element Frontespizio_SCE_Type/Scelte/Scelta8PerMille

diagram	
namespace	urn:www.agenziaentrate.gov.it:specificheTecniche:sco:sce:v1
type	sce:Scelta8PerMille_Type
properties	isRef 0 minOcc 0 maxOcc 1 content complex
children	sce:Stato sce:ChiesaCattolica sce:UnioneChieseCristianeAvventiste7giorno sce:AssembleeDiDioInItalia sce:UnioneDelleChieseMetodisteValdesi sce:ChiesaEvangelicaLuteranaInItalia sce:UnioneComunitaEbraicheItaliane sce:SceltaNonEffettuata sce:Anomalia
source	<pre><xs:element name="Scelta8PerMille" type="sce:Scelta8PerMille_Type" minOccurs="0"/></pre>

element Frontespizio_SCE_Type/Scelte/CryptedScelte

diagram	
namespace	urn:www.agenziaentrate.gov.it:specificheTecniche:sco:sce:v1
type	xs:base64Binary
properties	isRef 0 content simple
source	<pre><xs:element name="CryptedScelte" type="xs:base64Binary"/></pre>

complexType Intestazione_SCE_Type

diagram	
namespace	urn:www.agenziaentrate.gov.it:specificheTecniche:sco:sce:v1
children	sce:CodiceFornitura sce:TipoFornitore sce:CodiceFiscaleFornitore sce:SpazioUtente sce:SpazioServizioTelematico
source	<pre> <xs:complexType name="Intestazione_SCE_Type"> <xs:sequence> <xs:element name="CodiceFornitura"> <xs:simpleType> <xs:restriction base="cm:CodiceFornitura_Type"> <xs:enumeration value="SCE12"/> <xs:enumeration value="SCS12"/> </xs:restriction> </xs:simpleType> </xs:element> <xs:element name="TipoFornitore"> <xs:simpleType> <xs:restriction base="cm:DatoAN_Type"> <xs:enumeration value="1"/> <xs:enumeration value="10"/> </xs:restriction> </xs:simpleType> </xs:element> <xs:element name="CodiceFiscaleFornitore" type="cm:DatoCF_Type"/> <xs:element name="SpazioUtente" type="cm:DatoAN_Type" minOccurs="0"/> <xs:element name="SpazioServizioTelematico" type="cm:DatoAN_Type" minOccurs="0"/> </xs:sequence> </xs:complexType> </pre>

element Intestazione_SCE_Type/CodiceFornitura

diagram	
namespace	urn:www.agenziaentrate.gov.it:specificheTecniche:sco:sce:v1

type	restriction of CodiceFornitura_Type
properties	isRef 0 content simple
facets	Kind Value annotation length 5 pattern [0-9A-Z-]{1}([0-9A-Z] \- \.& _ _ / ° ^\(\))* enumeration SCE12 enumeration SCS12
source	<pre><xs:element name="CodiceFornitura"> <xs:simpleType> <xs:restriction base="cm:CodiceFornitura_Type"> <xs:enumeration value="SCE12"/> <xs:enumeration value="SCS12"/> </xs:restriction> </xs:simpleType> </xs:element></pre>

element **Intestazione_SCE_Type/TipoFornitore**

diagram	
namespace	urn:www.agenziaentrate.gov.it:specificheTecniche:sco:sce:v1
type	restriction of DatoAN_Type
properties	isRef 0 content simple
facets	Kind Value annotation pattern [0-9A-Z-]{1}([0-9A-Z] \- \.& _ _ / ° ^\(\))* enumeration 1 enumeration 10
source	<pre><xs:element name="TipoFornitore"> <xs:simpleType> <xs:restriction base="cm:DatoAN_Type"> <xs:enumeration value="1"/> <xs:enumeration value="10"/> </xs:restriction> </xs:simpleType> </xs:element></pre>

element **Intestazione_SCE_Type/CodiceFiscaleFornitore**

diagram	
namespace	urn:www.agenziaentrate.gov.it:specificheTecniche:sco:sce:v1
type	DatoCF_Type
properties	isRef 0 content simple

facets	Kind Value pattern [0-9]{11}[A-Z]{6}[0-9LMNPQRSTUUV]{2}[A-Z]{1}[0-9LMNPQRSTUUV]{2}[A-Z]{1}[0-9LMNPQRSTUUV]{3}[A-Z]{1}	annotation
source	<code><xs:element name="CodiceFiscaleFornitore" type="cm:DatoCF_Type"/></code>	

element Intestazione_SCE_Type/SpazioUtente

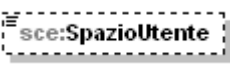
diagram		
namespace	urn:www.agenziaentrate.gov.it:specificheTecniche:sco:sce:v1	
type	DatoAN_Type	
properties	isRef 0 minOcc 0 maxOcc 1 content simple	
facets	Kind Value pattern [0-9A-Z-]{1}([0-9A-Z] \. \& _ s / ° °\)\)*	annotation
source	<code><xs:element name="SpazioUtente" type="cm:DatoAN_Type" minOccurs="0"/></code>	

element Intestazione_SCE_Type/SpazioServizioTelematico

diagram		
namespace	urn:www.agenziaentrate.gov.it:specificheTecniche:sco:sce:v1	
type	DatoAN_Type	
properties	isRef 0 minOcc 0 maxOcc 1 content simple	
facets	Kind Value pattern [0-9A-Z-]{1}([0-9A-Z] \. \& _ s / ° °\)\)*	annotation
source	<code><xs:element name="SpazioServizioTelematico" type="cm:DatoAN_Type" minOccurs="0"/></code>	

complexType **Scelta5PerMille_Type**

<p>diagram</p>	
<p>namespace</p>	<p>urn:www.agenziaentrate.gov.it:specificheTecniche:sco:sce:v1</p>
<p>children</p>	<p>sce:SostegnoVolontariatoNonLucrative sce:RicercaScientifica sce:RicercaSanitaria sce:BeniCulturaliPaesaggistici sce:SostegnoSocialeComune sce:SostegnoAssociazioniSportive sce:SceltaNonEffettuata sce:Anomalia sce:FlagAnomaliaCFbeneficiario</p>
<p>used by</p>	<p>elements Scelte_Type/Scelte5 Frontespizio SCE_Type/Scelte/Scelta5PerMille</p>
<p>source</p>	<pre> <xs:complexType name="Scelta5PerMille_Type"> <xs:sequence> <xs:element name="SostegnoVolontariatoNonLucrative" type="sc:Firma_Type" minOccurs="0"/> <xs:element name="RicercaScientifica" type="sc:Firma_Type" minOccurs="0"/> <xs:element name="RicercaSanitaria" type="sc:Firma_Type" minOccurs="0"/> <xs:element name="BeniCulturaliPaesaggistici" minOccurs="0"> <xs:complexType> <xs:sequence> <xs:element name="Firma" type="cm:DatoCB_Type"/> </xs:sequence> </xs:complexType> </xs:element> <xs:element name="SostegnoSocialeComune" minOccurs="0"> <xs:complexType> <xs:sequence> <xs:element name="Firma" type="cm:DatoCB_Type"/> </xs:sequence> </xs:complexType> </xs:element> <xs:element name="SostegnoAssociazioniSportive" </pre>

```

type="sc:Firma_Type" minOccurs="0"/>
  <xs:element name="SceltaNonEffettuata"
type="cm:DatoCB_Type" minOccurs="0"/>
  <xs:element name="Anomalia" minOccurs="0">
    <xs:simpleType>
      <xs:restriction base="cm:DatoN1_Type">
        <xs:enumeration value="1"/>
        <xs:enumeration value="2"/>
        <xs:enumeration value="3"/>
        <xs:enumeration value="4"/>
        <xs:enumeration value="5"/>
      </xs:restriction>
    </xs:simpleType>
  </xs:element>
  <xs:element name="FlagAnomaliaCFbeneficiario"
type="cm:DatoCB_Type" minOccurs="0"/>
</xs:sequence>
</xs:complexType>

```

element **Scelta5PerMille_Type/SostegnoVolontariatoNonLucrative**

diagram	
namespace	urn:www.agenziaentrate.gov.it:specificheTecniche:sco:sce:v1
type	Firma_Type
properties	isRef 0 minOcc 0 maxOcc 1 content complex
children	Firma CodiceFiscale
source	<xs:element name="SostegnoVolontariatoNonLucrative" type="sc:Firma_Type" minOccurs="0"/>

element **Scelta5PerMille_Type/RicercaScientifica**

diagram	
---------	--

namespace	urn:www.agenziaentrate.gov.it:specificheTecniche:sco:sce:v1
type	Firma_Type
properties	isRef 0 minOcc 0 maxOcc 1 content complex
children	Firma CodiceFiscale
source	<pre><xs:element name="RicercaScientifica" type="sc:Firma_Type" minOccurs="0"/></pre>

element **Scelta5PerMille_Type/RicercaSanitaria**

diagram	
namespace	urn:www.agenziaentrate.gov.it:specificheTecniche:sco:sce:v1
type	Firma_Type
properties	isRef 0 minOcc 0 maxOcc 1 content complex
children	Firma CodiceFiscale
source	<pre><xs:element name="RicercaSanitaria" type="sc:Firma_Type" minOccurs="0"/></pre>

element **Scelta5PerMille_Type/BeniCulturaliPaesaggistici**

diagram	
namespace	urn:www.agenziaentrate.gov.it:specificheTecniche:sco:sce:v1
properties	isRef 0 minOcc 0 maxOcc 1 content complex
children	sco:Firma
source	<pre><xs:element name="BeniCulturaliPaesaggistici" minOccurs="0"> <xs:complexType> <xs:sequence> <xs:element name="Firma" type="cm:DatoCB_Type"/> </xs:sequence> </xs:complexType> </xs:element></pre>

element **Scelta5PerMille_Type/BeniCulturaliPaesaggistici/Firma**

diagram	
namespace	urn:www.agenziaentrate.gov.it:specificheTecniche:sco:sce:v1
type	DatoCB_Type
properties	isRef 0 content simple
facets	Kind Value annotation pattern [01]
source	<pre><xs:element name="Firma" type="cm:DatoCB_Type"/></pre>

element **Scelta5PerMille_Type/SostegnoSocialeComune**

diagram	
namespace	urn:www.agenziaentrate.gov.it:specificheTecniche:sco:sce:v1
properties	isRef 0 minOcc 0 maxOcc 1 content complex
children	sce:Firma
source	<pre><xs:element name="SostegnoSocialeComune" minOccurs="0"> <xs:complexType> <xs:sequence> <xs:element name="Firma" type="cm:DatoCB_Type"/> </xs:sequence> </xs:complexType> </xs:element></pre>

element **Scelta5PerMille_Type/SostegnoSocialeComune/Firma**

diagram	
namespace	urn:www.agenziaentrate.gov.it:specificheTecniche:sco:sce:v1
type	DatoCB_Type
properties	isRef 0 content simple
facets	Kind Value annotation pattern [01]
source	<pre><xs:element name="Firma" type="cm:DatoCB_Type"/></pre>

element **Scelta5PerMille_Type/SostegnoAssociazioniSportive**

diagram									
namespace	urn:www.agenziaentrate.gov.it:specificheTecniche:sco:sce:v1								
type	Firma_Type								
properties	<table> <tr><td>isRef</td><td>0</td></tr> <tr><td>minOcc</td><td>0</td></tr> <tr><td>maxOcc</td><td>1</td></tr> <tr><td>content</td><td>complex</td></tr> </table>	isRef	0	minOcc	0	maxOcc	1	content	complex
isRef	0								
minOcc	0								
maxOcc	1								
content	complex								
children	Firma CodiceFiscale								
source	<pre><xs:element name="SostegnoAssociazioniSportive" type="sc:Firma_Type" minOccurs="0"/></pre>								

element **Scelta5PerMille_Type/SceltaNonEffettuata**

diagram									
namespace	urn:www.agenziaentrate.gov.it:specificheTecniche:sco:sce:v1								
type	DatoCB_Type								
properties	<table> <tr><td>isRef</td><td>0</td></tr> <tr><td>minOcc</td><td>0</td></tr> <tr><td>maxOcc</td><td>1</td></tr> <tr><td>content</td><td>simple</td></tr> </table>	isRef	0	minOcc	0	maxOcc	1	content	simple
isRef	0								
minOcc	0								
maxOcc	1								
content	simple								
facets	<table> <tr><td>Kind</td><td>Value</td><td>annotation</td></tr> <tr><td>pattern</td><td>[01]</td><td></td></tr> </table>	Kind	Value	annotation	pattern	[01]			
Kind	Value	annotation							
pattern	[01]								
source	<pre><xs:element name="SceltaNonEffettuata" type="cm:DatoCB_Type" minOccurs="0"/></pre>								

element **Scelta5PerMille_Type/Anomalia**

diagram																
namespace	urn:www.agenziaentrate.gov.it:specificheTecniche:sco:sce:v1															
type	restriction of DatoN1_Type															
properties	<table> <tr><td>isRef</td><td>0</td></tr> <tr><td>minOcc</td><td>0</td></tr> <tr><td>maxOcc</td><td>1</td></tr> <tr><td>content</td><td>simple</td></tr> </table>	isRef	0	minOcc	0	maxOcc	1	content	simple							
isRef	0															
minOcc	0															
maxOcc	1															
content	simple															
facets	<table> <tr><td>Kind</td><td>Value</td><td>annotation</td></tr> <tr><td>maxLength</td><td>1</td><td></td></tr> <tr><td>pattern</td><td>[1-9]</td><td></td></tr> <tr><td>enumeration</td><td>1</td><td></td></tr> <tr><td>enumeration</td><td>2</td><td></td></tr> </table>	Kind	Value	annotation	maxLength	1		pattern	[1-9]		enumeration	1		enumeration	2	
Kind	Value	annotation														
maxLength	1															
pattern	[1-9]															
enumeration	1															
enumeration	2															

	enumeration 3 enumeration 4 enumeration 5
source	<pre> <xs:element name="Anomalia" minOccurs="0"> <xs:simpleType> <xs:restriction base="cm:DatoN1_Type"> <xs:enumeration value="1"/> <xs:enumeration value="2"/> <xs:enumeration value="3"/> <xs:enumeration value="4"/> <xs:enumeration value="5"/> </xs:restriction> </xs:simpleType> </xs:element> </pre>

element **Scelta5PerMille_Type/FlagAnomaliaCFbeneficiario**

diagram	
namespace	urn:www.agenziaentrate.gov.it:specificheTecniche:sco:sce:v1
type	DatoCB_Type
properties	isRef 0 minOcc 0 maxOcc 1 content simple
facets	Kind Value annotation pattern [01]
source	<pre> <xs:element name="FlagAnomaliaCFbeneficiario" type="cm:DatoCB_Type" minOccurs="0"/> </pre>

complexType **Scelta8PerMille_Type**

<p>diagram</p>	
<p>namespace</p>	<p>urn:www.agenziaentrate.gov.it:specificheTecniche:sco:sce:v1</p>
<p>children</p>	<p>sce:Stato sce:ChiesaCattolica sce:UnioneChieseCristianeAvventiste7giorno sce:AssembleeDiDioInItalia sce:UnioneDelleChieseMetodisteValdesi sce:ChiesaEvangelicaLuteranaInItalia sce:UnioneComunitaEbraicheItaliane sce:SceltaNonEffettuata sce:Anomalia</p>
<p>used by</p>	<p>elements Scelte_Type/Scelte8 Frontespizio SCE_Type/Scelte/Scelta8PerMille</p>
<p>source</p>	<pre> <xs:complexType name="Scelta8PerMille_Type"> <xs:sequence> <xs:element name="Stato" type="cm:DatoCB_Type" minOccurs="0"/> <xs:element name="ChiesaCattolica" type="cm:DatoCB_Type" minOccurs="0"/> <xs:element name="UnioneChieseCristianeAvventiste7giorno" type="cm:DatoCB_Type" minOccurs="0"/> <xs:element name="AssembleeDiDioInItalia" type="cm:DatoCB_Type" minOccurs="0"/> <xs:element name="UnioneDelleChieseMetodisteValdesi" type="cm:DatoCB_Type" minOccurs="0"/> <xs:element name="ChiesaEvangelicaLuteranaInItalia" type="cm:DatoCB_Type" minOccurs="0"/> <xs:element name="UnioneComunitaEbraicheItaliane" type="cm:DatoCB_Type" minOccurs="0"/> <xs:element name="SceltaNonEffettuata" type="cm:DatoCB_Type" minOccurs="0"/> <xs:element name="Anomalia" minOccurs="0"> <xs:simpleType> <xs:restriction base="cm:DatoN1_Type"> <xs:enumeration value="1"/> <xs:enumeration value="2"/> <xs:enumeration value="3"/> </xs:restriction> </xs:simpleType> </xs:element> </xs:sequence> </xs:complexType> </pre>

	<pre> </xs:restriction> </xs:simpleType> </xs:element> </xs:sequence> </xs:complexType> </pre>
--	--

element Scelta8PerMille_Type/Stato

diagram	
namespace	urn:www.agenziaentrate.gov.it:specificheTecniche:sco:sce:v1
type	DatoCB_Type
properties	isRef 0 minOcc 0 maxOcc 1 content simple
facets	Kind Value annotation pattern [01]
source	<pre><xs:element name="Stato" type="cm:DatoCB_Type" minOccurs="0"/></pre>

element Scelta8PerMille_Type/ChiesaCattolica

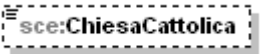
diagram	
namespace	urn:www.agenziaentrate.gov.it:specificheTecniche:sco:sce:v1
type	DatoCB_Type
properties	isRef 0 minOcc 0 maxOcc 1 content simple
facets	Kind Value annotation pattern [01]
source	<pre><xs:element name="ChiesaCattolica" type="cm:DatoCB_Type" minOccurs="0"/></pre>

element Scelta8PerMille_Type/UnioneChieseCristianeAvventiste7giorno

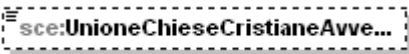
diagram	
namespace	urn:www.agenziaentrate.gov.it:specificheTecniche:sco:sce:v1
type	DatoCB_Type
properties	isRef 0 minOcc 0 maxOcc 1 content simple
facets	Kind Value annotation

	pattern [01]
source	<code><xs:element name="UnioneChieseCristianeAvventiste7giorno" type="cm:DatoCB_Type" minOccurs="0"/></code>

element **Scelta8PerMille_Type/AssembleeDiDioInItalia**

diagram	
namespace	urn:www.agenziaentrate.gov.it:specificheTecniche:sco:sce:v1
type	DatoCB_Type
properties	isRef 0 minOcc 0 maxOcc 1 content simple
facets	Kind Value annotation pattern [01]
source	<code><xs:element name="AssembleeDiDioInItalia" type="cm:DatoCB_Type" minOccurs="0"/></code>

element **Scelta8PerMille_Type/UnioneDelleChieseMetodisteValdesi**

diagram	
namespace	urn:www.agenziaentrate.gov.it:specificheTecniche:sco:sce:v1
type	DatoCB_Type
properties	isRef 0 minOcc 0 maxOcc 1 content simple
facets	Kind Value annotation pattern [01]
source	<code><xs:element name="UnioneDelleChieseMetodisteValdesi" type="cm:DatoCB_Type" minOccurs="0"/></code>

element **Scelta8PerMille_Type/ChiesaEvangelicaLuteranaInItalia**

diagram	
namespace	urn:www.agenziaentrate.gov.it:specificheTecniche:sco:sce:v1
type	DatoCB_Type
properties	isRef 0 minOcc 0 maxOcc 1 content simple
facets	Kind Value annotation pattern [01]
source	<code><xs:element name="ChiesaEvangelicaLuteranaInItalia" type="cm:DatoCB_Type" minOccurs="0"/></code>

	<code>type="cm:DatoCB_Type" minOccurs="0"/></code>
--	---

element **Scelta8PerMille_Type/UnioneComunitaEbraicheItaliane**

diagram	
namespace	urn:www.agenziaentrate.gov.it:specificheTecniche:sco:sce:v1
type	DatoCB_Type
properties	isRef 0 minOcc 0 maxOcc 1 content simple
facets	Kind Value annotation pattern [01]
source	<code><xs:element name="UnioneComunitaEbraicheItaliane" type="cm:DatoCB_Type" minOccurs="0"/></code>

element **Scelta8PerMille_Type/SceltaNonEffettuata**

diagram	
namespace	urn:www.agenziaentrate.gov.it:specificheTecniche:sco:sce:v1
type	DatoCB_Type
properties	isRef 0 minOcc 0 maxOcc 1 content simple
facets	Kind Value annotation pattern [01]
source	<code><xs:element name="SceltaNonEffettuata" type="cm:DatoCB_Type" minOccurs="0"/></code>

element **Scelta8PerMille_Type/Anomalia**

diagram	
namespace	urn:www.agenziaentrate.gov.it:specificheTecniche:sco:sce:v1
type	restriction of DatoN1_Type
properties	isRef 0 minOcc 0 maxOcc 1 content simple
facets	Kind Value annotation maxLength 1 pattern [1-9] enumeration 1 enumeration 2

	enumeration 3
source	<pre><xs:element name="Anomalia" minOccurs="0"> <xs:simpleType> <xs:restriction base="cm:DatoN1_Type"> <xs:enumeration value="1"/> <xs:enumeration value="2"/> <xs:enumeration value="3"/> </xs:restriction> </xs:simpleType> </xs:element></pre>

simpleType DatoAN_Type

namespace	urn:www.agenziaentrate.gov.it:specificheTecniche:common:v2
type	restriction of xs:string
properties	base xs:string
used by	<p>elements</p> <p>Domicilio EE Type/CodiceComune Domicilio Ita Type/CodiceComune Firma Type/CodiceFiscale Soggetti Non Residenti Type/CodiceIdentificazioneEstero Soggetti Non Residenti Type/CodiceStatoEstero Residenza Estera Type/CodiceStatoEstero Dati Anagrafici Type/Cognome Domicilio Ita Type/Comune Domicilio EE Type/Comune Dati Anagrafici Type/ComuneNascita Soggetti Diversi Da PF Type/Denominazione Domicilio Ita Type/Indirizzo Domicilio EE Type/Indirizzo Residenza Estera Type/IndirizzoEstero Residenza Estera Type/LocalitaEstero Domicilio Sogg Ass Fiscale Type/Cap Residenza Type/Cap Soggetto Fiscale 730 Type/Cellulare Annotazioni Prospetto Type/Codice Eccedenze Type/CodiceCatastaleComune FabbricatoOrd Type/CodiceComune Domicilio Fiscale type/CodiceComune ImportiTrattenere730-4/AddComTrattenere/CodiceComune ImportiTrattenere730-4/AddComAccontoTrattenere/CodiceComune Importi Rimborsare730-4 Type/AddComRimborsare/CodiceComune Residenza Type/CodiceComune Dati Catastali Recupero Patrimonio Edilizio Type/CodiceComune Domicilio Sogg Ass Fiscale Type/CodiceComune Sostituto Type/CodiceSede Documento 730-4/SoggettoAssFiscale730-4/DatiCaf730-4/UfficioPerifericoCaf/DomicilioUffPeriferico/CodiceSedePeriferica Dati Contratto Type/CodiceUfficio Dati Registrazione Accatastamento Recupero Patrimonio Edilizio Type/CodiceUfficioDomandaAccatastamento Sostituto Type/DatiAnagraficiPF/Cognome Dati Associazioni Professionale Type/CognomeProfessionista Dati Professionista Type/CognomeProfessionista Soggetto Assistenza FiscaliDoc type/DatiCafDoc/CognomeResponsabile Residenza Type/Comune Domicilio Fiscale type/Comune Domicilio Sogg Ass Fiscale Type/Comune Dati Nascita PF Type/ComuneNascita Dati Catastali Recupero Patrimonio Edilizio Type/Particella/Denominatore Dati Associazioni Professionale Type/DenominazioneAssociazione Dati CAF Type/DenominazioneCaf Sostituto Type/DenominazionePNF Sostituto Type/Fax Domicilio Sogg Ass Fiscale Type/FAX Dati Catastali Recupero Patrimonio Edilizio Type/Foglio Residenza Anagrafica 730 Type/Frazione Residenza Type/Frazione Residenza Rappresentante Type/Frazione Residenza Type/Indirizzo Domicilio Sogg Ass Fiscale Type/Indirizzo Sostituto Type/DatiAnagraficiPF/Nome Dati Professionista Type/NomeProfessionista Dati Associazioni Professionale Type/NomeProfessionista Soggetto Assistenza FiscaliDoc type/DatiCafDoc/NomeResponsabile Residenza Type/NumCivico Residenza Rappresentante Type/NumCivico Residenza Anagrafica 730 Type/NumCivico Dati Catastali Recupero Patrimonio Edilizio Type/Particella/Numeratore Dati Contratto Type/NumeroContratto Dati Registrazione Accatastamento Recupero Patrimonio Edilizio Type/NumeroDomandaAccatastamento Dati Familiare Type/PercDetrazCon Dati Catastali Recupero Patrimonio Edilizio Type/SezioneUrbanaComuneCatastale Dati Contratto Type/Sottonumero Documento 730 Type/AltriDati/SpazioDisposizioneUtente Documento 730-4/AltriDati/SpazioDisposizioneUtente Dati Catastali Recupero Patrimonio Edilizio Type/Subalterno</p>

	Soggetto Fiscale 730 Type/Telefono Residenza Type/Telefono Domicilio Sogg Ass Fiscale Type/Telefono Dati Primo Figlio Type/Tipologia Familiari PrimoModulo Type/Familiari/Tipologia Familiari PrimoModulo Type/PrimoFiglio/Tipologia Modulo Familiari Type/Familiari/Tipologia Modulo Familiari Type/PrimoFiglio/Tipologia Residenza Rappresentante Type/Tipologia Residenza Type/Tipologia Residenza Anagrafica 730 Type/Tipologia Dati Anagrafici Type/Nome Documento SCE Type/CfBusta Documento SCE Type/BanchePoste/CodCentroOperativo Fornitura/Intestazione/UfficioPerifericoCAF/CodiceComune Frontespizio SCE Type/CodiceFiscale DatiAnagraficiScelte Type/Cognome DatiAnagraficiScelte Type/ComuneNascita Fornitura/Intestazione/UfficioPerifericoCAF/Indirizzo DatiAnagraficiScelte Type/Nome Documento SCE Type/BanchePoste/NumeroProtocollo Intestazione SCE Type/SpazioServizioTelematico Intestazione SCE Type/SpazioUtente Fornitura/Intestazione/TipologiaFornitore Intestazione SCE Type/TipologiaFornitore Dati Intestazione Type/SpazioServizioTelematico Dati Intestazione Type/SpazioUtente Soggetti Non Residenti Type/StatoEstero Residenza Estera Type/StatoFederato Casella Quadro Type/Codice Regione Type CodiceFornitura Type/Intero Porzione Type Serie Registrazione Contratto Type/Sesso Type Terreni Urbano Type						
facets	<table border="1"> <tr> <td>Kind</td> <td>Value</td> <td>annotation</td> </tr> <tr> <td>pattern</td> <td>[0-9A-Z]{1}([0-9A-Z] ' \\. & , s / ° ^\ \\(\))*</td> <td></td> </tr> </table>	Kind	Value	annotation	pattern	[0-9A-Z]{1}([0-9A-Z] ' \\. & , s / ° ^\ \\(\))*	
Kind	Value	annotation					
pattern	[0-9A-Z]{1}([0-9A-Z] ' \\. & , s / ° ^\ \\(\))*						
annotation	<p>documentation</p> <p>Tipo semplice costituito da caratteri alfanumerici maiuscoli e dai caratteri: punto, virgola, apice, trattino, spazio, /, °, ^, ampersand. I caratteri: punto, virgola, apice, spazio, /, °, ^ e ampersand non sono ammessi come primo carattere della stringa.</p>						
source	<pre><xs:simpleType name="DatoAN_Type"> <xs:annotation> <xs:documentation>Tipo semplice costituito da caratteri alfanumerici maiuscoli e dai caratteri: punto, virgola, apice, trattino, spazio, /, °, ^, ampersand. I caratteri: punto, virgola, apice, spazio, /, °, ^ e ampersand non sono ammessi come primo carattere della stringa.</xs:documentation> </xs:annotation> <xs:restriction base="xs:string"> <xs:pattern value="[0-9A-Z\-' \\. & , s / ° ^\ \\(\))*"/> </xs:restriction> </xs:simpleType></pre>						

simpleType DatoCB12_Type

namespace	urn:www.agenziaentrate.gov.it:specificheTecniche:common:v2						
type	restriction of xs:byte						
properties	base xs:byte						
facets	<table border="1"> <tr> <td>Kind</td> <td>Value</td> <td>annotation</td> </tr> <tr> <td>pattern</td> <td>[10]{12}</td> <td></td> </tr> </table>	Kind	Value	annotation	pattern	[10]{12}	
Kind	Value	annotation					
pattern	[10]{12}						
annotation	<p>documentation</p> <p>Tipo semplice che consente esclusivamente 12 caratteri con i valori 0 e 1.</p>						
source	<pre><xs:simpleType name="DatoCB12_Type"> <xs:annotation> <xs:documentation>Tipo semplice che consente esclusivamente 12 caratteri con i valori 0 e 1.</xs:documentation> </xs:annotation></pre>						

```

<xs:restriction base="xs:byte">
  <xs:pattern value="[10]{12}"/>
</xs:restriction>
</xs:simpleType>

```

simpleType DatoCB_Type

namespace	urn:www.agenziaentrare.gov.it:specificheTecniche:common:v2
type	restriction of xs:byte
properties	base xs:byte
used by	<p>elements</p> <p>Tipo Dichiarazione Type/Correttiva Firma Type/Firma Visto Conformita Type/Firma Firma Revisore Type/FirmaDichiarante Impegno A Trasmettere Type/FirmaIntermediario Tipo Dichiarazione Type/Integrativa Tipo Dichiarazione Type/IntegrativaAFavore Tipo Dichiarazione Type/IntegrativaArt2Co8Ter Dati Familiare Type/Affidamento Dati Primo Figlio Type/Affidamento Soglie Esenzione Type/AltreAgevolazioni Documento 730-4/AltriDati/Annullamento Fuori Assistenza Type/AnomaliaAltriRedditi Fuori Assistenza Type/AnomaliaDatianagrafici Dichiarazione Dich Type/FuoriAssistenza/AnomaliaDatiRappresentante Dichiarazione Dich Type/FuoriAssistenza/AnomaliaDatiSostituto Fuori Assistenza Type/AnomaliaFabbricati Fuori Assistenza Type/AnomaliaLavDip Fuori Assistenza Type/AnomaliaQuadroF Fuori Assistenza Type/AnomaliaTerreni Altri Redditi Ass Lavd Type/AssegnoDelConiuge ICI Type/Casella Casella Acconto Type/Casella FabbricatoOrd Type/CasellaContinuazione Terreno Type/CasellaContinuazione FabbricatoAgev Type/CasellaInf30Giorni Detrazioni Type/CasellaVederelstruzioni Dati Registrazione Accatastamento Recupero Patrimonio Edilizio Type/COPescaraCondominio Dati Catastali Recupero Patrimonio Edilizio Type/COPescaraCondominio Documento 730 Type/AltriDati/DichiarazioneCongiunta Soglie Esenzione Type/EsenzioneTotale Frontespizio Dich Type/Rappresentante/Firma Firma Dichiarazione Type/FirmaDichiarazione Documento 730 Type/AltriDati/FlagAssenzaDati730-4 Documento 730 Type/AltriDati/FlagCfErratoDicTrasmessa Documento 730 Type/AltriDati/FlagConferma Crediti Imposta Altri Sisma Abruzzo Type/Impresa Professione Tassazione Separata Type/Opzione FabbricatoOrd Type/OpzioneCedolare Firma Dichiarazione Type/OpzioneInformativa Residenza Rappresentante Type/PrimaPresentazione Residenza Anagrafica 730 Type/PrimaPresentazione Documento 730 Type/AltriDati/Rettificativo Documento 730-4/AltriDati/Rettificativo Firma Dichiarazione Type/SoggettoFiscalmenteCarico Dati Altre Detrazioni Type/SpeseCaniGuida Incremento Produttivita Type/TassazOrdinaria Incremento Produttivita Type/TassazSostitutiva Dati Coniuge Type/Tipo Dati Sottoscrittore Type/ProceduraNonTerminata Impegno A Trasmettere Type/RicezioneAvvisoTelem Scelta8PerMille Type/AssembleeDiDiolnItalia Documento SCE Type/BustaVuota Scelta8PerMille Type/ChiesaCattolica Scelta8PerMille Type/ChiesaEvangelicaLuteranalnItalia Scelta5PerMille Type/BeniCulturaliPaesaggistici/Firma Scelta5PerMille Type/SostegnoSocialeComune/Firma Dichiarazione SCE Type/FlagAnomaliaCFAnaq Scelta5PerMille Type/FlagAnomaliaCFbeneficiario Documento SCE Type/BanchePoste/FormatoErrato Documento SCE Type/BanchePoste/ProtIDmodErrato Scelta8PerMille Type/SceltaNonEffettuata Scelta5PerMille Type/SceltaNonEffettuata Scelta8PerMille Type/Stato Scelta8PerMille Type/UnioneChieseCristianeAvventiste7giorno Scelta8PerMille Type/UnioneComunitaEbraicheltaliane Scelta8PerMille Type/UnioneDelleChieseMetodisteValdesi</p>
facets	Kind Value annotation pattern [01]
annotation	documentation Tipo semplice che consente esclusivamente i valori 0 e 1.
source	<pre> <xs:simpleType name="DatoCB_Type"> <xs:annotation> <xs:documentation>Tipo semplice che consente esclusivamente i valori 0 e 1.</xs:documentation> </pre>

	<pre> </xs:annotation> <xs:restriction base="xs:string"> <xs:pattern value="[01]" /> </xs:restriction> </xs:simpleType> </pre>
--	--

simpleType DatoCF_Type

namespace	urn:www.agenziaentrate.gov.it:specificheTecniche:common:v2		
type	restriction of xs:string		
properties	base xs:string		
used by	elements	Impegno A Trasmettere Type/CFintermediario Visto Conformita Type/CFprofessionista Visto Conformita Type/VistoCAF/CFResp Soggetto Fiscale Type/CodiceFiscale Dati Sottoscrittore Type/CodiceFiscale Firma Revisore Type/CodiceFiscale Dati Intestazione Type/CodiceFiscaleFornitore Documento 730-4/DatiAnagraficiDichiarante/CFDichiarante Documento 730 Type/AltriDati/CfProduttoreSoftware Dati Professionista Type/CFProfessionista Dati Associazioni Professionale Type/CFProfessionista Soggetto Assistenza FiscaliDoc type/DatiCafDoc/CFResponsabile Soggetto Fiscale 730 Type/CodiceFiscale Intervento Recupero Patrimonio Edilizio Type/CodiceFiscale Assegno Coniuge Type/CodiceFiscale Credito Immobile Sisma Abruzzo Type/CodiceFiscale Dati Coniuge Type/CodiceFiscale Dati Primo Figlio Type/CodiceFiscale Dati Familiare Type/CodiceFiscale Sostituto Type/CodiceFiscale Soggetto Assistenza FiscaliDoc type/SostitutoCF Intestazione SCE Type/CodiceFiscaleFornitore	
facets	Kind	Value	annotation
	pattern	[0-9]{11}[A-Z]{6}[0-9LMNPQRSTU]{2}[A-Z]{1}[0-9LMNPQRSTU]{2}[A-Z]{1}[0-9LMNPQRSTU]{3}[A-Z]{1}	
annotation	documentation	Tipo semplice che identifica un codice fiscale provvisorio o alfanumerico rispettandone i vincoli di struttura.	
source	<pre> <xs:simpleType name="DatoCF_Type"> <xs:annotation> <xs:documentation>Tipo semplice che identifica un codice fiscale provvisorio o alfanumerico rispettandone i vincoli di struttura.</xs:documentation> </xs:annotation> <xs:restriction base="xs:string"> <xs:pattern value="[0-9]{11} [A-Z]{6}[0-9LMNPQRSTU]{2}[A-Z]{1}[0-9LMNPQRSTU]{2}[A-Z]{1}[0-9LMNPQRSTU]{3}[A-Z]{1}" /> </xs:restriction> </xs:simpleType> </pre>		

simpleType DatoCN_Type

namespace	urn:www.agenziaentrate.gov.it:specificheTecniche:common:v2		
type	restriction of xs:string		
properties	base xs:string		
used by	elements	Visto Conformita Type/VistoCAF/CF CAF Dati Sottoscrittore Type/CodiceFiscaleSocieta Dati Associazioni Professionale Type/CFAssociazione Dati CAF Type/CFCaf	
facets	Kind	Value	annotation
	length	11	

	pattern [0-9]{11}
annotation	documentation Tipo semplice che identifica un codice fiscale numerico rispettandone i vincoli di struttura.
source	<pre><xs:simpleType name="DatoCN_Type"> <xs:annotation> <xs:documentation>Tipo semplice che identifica un codice fiscale numerico rispettandone i vincoli di struttura.</xs:documentation> </xs:annotation> <xs:restriction base="xs:string"> <xs:length value="11"/> <xs:pattern value="[0-9]{11}"/> </xs:restriction> </xs:simpleType></pre>

simpleType DatoCP_Type

namespace	urn:www.agenziaentrate.gov.it:specificheTecniche:common:v2
type	restriction of xs:string
properties	base xs:string
used by	elements Domicilio Ita Type/Cap Domicilio EE Type/Cap Fornitura/Intestazione/UfficioPerifericoCAF/Cap
facets	Kind Value annotation pattern [0-9]{5}
annotation	documentation Tipo semplice che identifica un elemento di tipo cap
source	<pre><xs:simpleType name="DatoCP_Type"> <xs:annotation> <xs:documentation>Tipo semplice che identifica un elemento di tipo cap</xs:documentation> </xs:annotation> <xs:restriction base="xs:string"> <xs:pattern value="[0-9]{5}"/> </xs:restriction> </xs:simpleType></pre>

simpleType DatoD6_Type

namespace	urn:www.agenziaentrate.gov.it:specificheTecniche:common:v2
type	restriction of xs:string
properties	base xs:string
used by	elements Domicilio Fiscale Type/DataVariazione Domicilio EE Type/DataVariazione
facets	Kind Value annotation length 6 pattern ((0[0-9]) (1[0-2]))((19 20)[0-9][0-9])
annotation	documentation Tipo semplice che identifica una data nel formato mmaaaa.

source	<pre> <xs:simpleType name="DatoD6_Type"> <xs:annotation> <xs:documentation>Tipo semplice che identifica una data nel formato mmaaaa.</xs:documentation> </xs:annotation> <xs:restriction base="xs:string"> <xs:length value="6"/> <xs:pattern value="((0[0-9]) (1[0-2])) ((19 20) [0-9] [0- 9]) " /> </xs:restriction> </xs:simpleType> </pre>
--------	--

simpleType DatoDA_Type

namespace	urn:www.agenziaentrate.gov.it:specificheTecniche:common:v2									
type	restriction of xs:string									
properties	base xs:string									
used by	elements Tassazione Separata Type/Anno FabbriatoAgev Type/AnnoDichiarazioneIci									
facets	<table border="1"> <thead> <tr> <th>Kind</th> <th>Value</th> <th>annotation</th> </tr> </thead> <tbody> <tr> <td>length</td> <td>4</td> <td></td> </tr> <tr> <td>pattern</td> <td>(18 19 20)[0-9]{2}</td> <td></td> </tr> </tbody> </table>	Kind	Value	annotation	length	4		pattern	(18 19 20)[0-9]{2}	
Kind	Value	annotation								
length	4									
pattern	(18 19 20)[0-9]{2}									
annotation	documentation Tipo semplice che identifica un anno nel formato aaaa. Sono ammessi anni dal 1800 al 2099.									
source	<pre> <xs:simpleType name="DatoDA_Type"> <xs:annotation> <xs:documentation>Tipo semplice che identifica un anno nel formato aaaa. Sono ammessi anni dal 1800 al 2099.</xs:documentation> </xs:annotation> <xs:restriction base="xs:string"> <xs:length value="4"/> <xs:pattern value="(18 19 20) [0-9] {2} " /> </xs:restriction> </xs:simpleType> </pre>									

simpleType DatoDN_Type

namespace	urn:www.agenziaentrate.gov.it:specificheTecniche:common:v2									
type	restriction of xs:string									
properties	base xs:string									
used by	element Cred Imp Estero Type/Anno									
facets	<table border="1"> <thead> <tr> <th>Kind</th> <th>Value</th> <th>annotation</th> </tr> </thead> <tbody> <tr> <td>length</td> <td>8</td> <td></td> </tr> <tr> <td>pattern</td> <td>((([0-9]{12}[0-9]{3}[01])([013578][10]12)\d{4}) ((([01-9]{12}[0-9]{30})([0469][11]\d{4})) ((([01-9]{1}[0-9]{2}[0-8])(02)\d{4})) ((29)(02)([02468][048]00)) ((29)(02)([13579][26]00)) ((29)(02)([0-9][0-</td> <td></td> </tr> </tbody> </table>	Kind	Value	annotation	length	8		pattern	((([0-9]{12}[0-9]{3}[01])([013578][10]12)\d{4}) ((([01-9]{12}[0-9]{30})([0469][11]\d{4})) ((([01-9]{1}[0-9]{2}[0-8])(02)\d{4})) ((29)(02)([02468][048]00)) ((29)(02)([13579][26]00)) ((29)(02)([0-9][0-	
Kind	Value	annotation								
length	8									
pattern	((([0-9]{12}[0-9]{3}[01])([013578][10]12)\d{4}) ((([01-9]{12}[0-9]{30})([0469][11]\d{4})) ((([01-9]{1}[0-9]{2}[0-8])(02)\d{4})) ((29)(02)([02468][048]00)) ((29)(02)([13579][26]00)) ((29)(02)([0-9][0-									

	9[0][48]))((29)(02)([0-9][0-9][2468][048]))((29)(02)([0-9][0-9][13579][26]))))
annotation	documentation Tipo semplice che identifica una data nel formato ggmmaaaa.
source	<pre><xs:simpleType name="DatoDN_Type"> <xs:annotation> <xs:documentation>Tipo semplice che identifica una data nel formato ggmmaaaa.</xs:documentation> </xs:annotation> <xs:restriction base="xs:string"> <xs:length value="8"/> <xs:pattern value="((([0-9] [12][0-9] 3[01])([013578] 10 12)\d{4})) ((([0-9] [12][0-9] 30)([0469] 11)\d{4})) ((([0-9] 1[0-9] 2[0-8])(02)\d{4})) ((29)(02)([02468][048]00)) ((29)(02)([13579][26]00)) ((29)(02)([0-9][0-9][0][48])) ((29)(02)([0-9][0-9][2468][048])) ((29)(02)([0-9][0-9][13579][26]))))"/> </xs:restriction> </xs:simpleType></pre>

simpleType DatoDT_Type

namespace	urn:www.agenziaentrate.gov.it:specificheTecniche:common:v2									
type	restriction of xs:string									
properties	base xs:string									
used by	<p>elements</p> <p>Soggetti Diversi Da PF Type/DataApprovazioneBilancio Dati Sottoscrittore Type/DataCarica Impegno A Trasmettere Type/DataImpegno Dati Anagrafici Type/DataNascita Residenza Anagrafica Type/DataVariazione Soggetti Diversi Da PF Type/FinePeriodoImposta Dati Sottoscrittore Type/FineProcedura Soggetti Diversi Da PF Type/InizioPeriodoImposta Dati Sottoscrittore Type/InizioProcedura Soggetto Assistenza FiscaliDoc type/DataConsegna Dati Registrazione Accatastamento Recupero Patrimonio Edilizio Type/DataDomandaAccatastamento Dati Nascita PF Type/DataNascita Dati Contratto Type/DataRegContratto DatiAnagraficiScelte Type/DataNascita Soggetti Diversi Da PF Type/TermineApprovazioneBilancio</p>									
facets	<table border="1"> <thead> <tr> <th>Kind</th> <th>Value</th> <th>annotation</th> </tr> </thead> <tbody> <tr> <td>length</td> <td>8</td> <td></td> </tr> <tr> <td>pattern</td> <td>((([0-9] [12][0-9] 3[01])([013578] 10 12)\d{4})) ((([0-9] [12][0-9] 30)([0469] 11)\d{4})) ((([0-9] 1[0-9] 2[0-8])(02)\d{4})) ((29)(02)([02468][048]00)) ((29)(02)([13579][26]00)) ((29)(02)([0-9][0-9][0][48])) ((29)(02)([0-9][0-9][2468][048])) ((29)(02)([0-9][0-9][13579][26]))))</td> <td></td> </tr> </tbody> </table>	Kind	Value	annotation	length	8		pattern	((([0-9] [12][0-9] 3[01])([013578] 10 12)\d{4})) ((([0-9] [12][0-9] 30)([0469] 11)\d{4})) ((([0-9] 1[0-9] 2[0-8])(02)\d{4})) ((29)(02)([02468][048]00)) ((29)(02)([13579][26]00)) ((29)(02)([0-9][0-9][0][48])) ((29)(02)([0-9][0-9][2468][048])) ((29)(02)([0-9][0-9][13579][26]))))	
Kind	Value	annotation								
length	8									
pattern	((([0-9] [12][0-9] 3[01])([013578] 10 12)\d{4})) ((([0-9] [12][0-9] 30)([0469] 11)\d{4})) ((([0-9] 1[0-9] 2[0-8])(02)\d{4})) ((29)(02)([02468][048]00)) ((29)(02)([13579][26]00)) ((29)(02)([0-9][0-9][0][48])) ((29)(02)([0-9][0-9][2468][048])) ((29)(02)([0-9][0-9][13579][26]))))									
annotation	documentation Tipo semplice che identifica una data nel formato ggmmaaaa. La data indicata non deve essere successiva alla data corrente.									
source	<pre><xs:simpleType name="DatoDT_Type"> <xs:annotation> <xs:documentation>Tipo semplice che identifica una data nel formato ggmmaaaa. La data indicata non deve essere successiva alla data corrente.</xs:documentation> </xs:annotation> <xs:restriction base="xs:string"> <xs:length value="8"/> <xs:pattern value="((([0-9] [12][0-</pre>									

	<pre> 9] 3[01]) (0[13578] 10 12) (\d{4})) (([0][1-9] [12][0-9] 30) (0[469] 11) (\d{4})) ((0[1-9] 1[0-9] 2[0-8]) (02) (\d{4})) ((29) (02) ([02468][048]00)) ((29) (02) ([13579][26]00)) ((29) (02) ([0-9][0-9][0][48])) ((29) (02) ([0-9][0-9][2468][048])) ((29) (02) ([0-9][0-9][13579][26]))))" /> </xs:restriction> </xs:simpleType> </pre>
--	---

simpleType DatoEM_Type

namespace	urn:www.agenziaentrate.gov.it:specificheTecniche:common:v2
type	restriction of xs:string
properties	base xs:string
used by	elements Soggetto Fiscale Type/Email Soggetto Fiscale 730 Type/Email Residenza Type/Email Domicilio Sogg Ass Fiscale Type/Email
facets	Kind Value annotation pattern [a-zA-Z0-9._%\\-]+@[a-zA-Z0-9\\.\\-]+\\.[a-zA-Z]{2,4}
annotation	documentation Tipo semplice che identifica un elemento di tipo email
source	<pre> <xs:simpleType name="DatoEM_Type"> <xs:annotation> <xs:documentation>Tipo semplice che identifica un elemento di tipo email</xs:documentation> </xs:annotation> <xs:restriction base="xs:string"> <xs:pattern value="[a-zA-Z0-9._%\\-]+@[a-zA-Z0-9\\.\\-]+\\.[a-zA-Z]{2,4}" /> </xs:restriction> </xs:simpleType> </pre>

simpleType DatoGA_Type

namespace	urn:www.agenziaentrate.gov.it:specificheTecniche:common:v2
type	restriction of xs:string
properties	base xs:string
used by	elements Periodo Di Lavoro Type/GiorniLavoroDipendente Periodo Di Lavoro Type/GiorniPensione Terreno Type/GiorniPossesso
facets	Kind Value annotation minLength 1 maxLength 3 pattern [1-9]([1-9][0-9]) ([12][0-9][0-9]) (3[0-5][0-9]) (36[0-5])
annotation	documentation Tipo semplice che identifica il numero di giorni in un anno e va da 1 a 365
source	<pre> <xs:simpleType name="DatoGA_Type"> <xs:annotation> <xs:documentation>Tipo semplice che identifica il numero di giorni in un anno e va da 1 a 365</xs:documentation> </xs:annotation> </pre>

	<pre> <xs:restriction base="xs:string"> <xs:minLength value="1"/> <xs:maxLength value="3"/> <xs:pattern value="[1-9] ([1-9][0-9]) ([12][0-9][0-9]) (3[0-5][0-9]) (36[0-5])"/> </xs:restriction> </xs:simpleType> </pre>
--	---

simpleType DatoN1_Type

namespace	urn:www.agenziaentrate.gov.it:specificheTecniche:common:v2									
type	restriction of xs:string									
properties	base xs:string									
used by	<p>elements Dati_CAF_Type/NumeroAlbo Documento 730-4/DatiContabili730-4/Ordinario 730-4/Conguaglio/NumeroRate Acconti Altri Dati_Type/Pignoramento/TipoRedditoPignoramento Acconti Ritenute_Type/Modulo/Pignoramento/TipoRedditoPignoramento Scelta8PerMille_Type/Anomalia Scelta5PerMille_Type/Anomalia Casella Codice_Type Casella Istruzioni_Type Casi Particolari Risp Ener_Type CasiParticolariFabbricato_Type CasiParticolariTerreni_Type Codice Evento Eccezionale_Type CodiceCanone_Type Indeterminato Determinato_Type Integrativo_Type Numero RateDa1A2_Type Numero RateDa1A3_Type Periodo 2006_Type Reintegro Totale Parziale_Type Tipo Intervento_Type Tipo Reddito Da1a3_Type Tipo Reddito Da1a6_Type Tipo Reddito Da1a7_Type Tipologia Soggetto AssFisc_Type TitoloTerreno_Type</p> <p>simpleTypes</p>									
facets	<table> <tr> <td>Kind</td> <td>Value</td> <td>annotation</td> </tr> <tr> <td>maxLength</td> <td>1</td> <td></td> </tr> <tr> <td>pattern</td> <td>[1-9]</td> <td></td> </tr> </table>	Kind	Value	annotation	maxLength	1		pattern	[1-9]	
Kind	Value	annotation								
maxLength	1									
pattern	[1-9]									
annotation	documentation Tipo semplice che identifica i numeri naturali da 1 a 9.									
source	<pre> <xs:simpleType name="DatoN1_Type"> <xs:annotation> <xs:documentation>Tipo semplice che identifica i numeri naturali da 1 a 9.</xs:documentation> </xs:annotation> <xs:restriction base="xs:string"> <xs:maxLength value="1"/> <xs:pattern value="[1-9]"/> </xs:restriction> </xs:simpleType> </pre>									

simpleType DatoNP_Type

namespace	urn:www.agenziaentrate.gov.it:specificheTecniche:common:v2
type	restriction of xs:string
properties	base xs:string
used by	<p>elements Impegno A Trasmettere_Type/ImpegnoATrasmettere Imposta Netta_Type/AccontiVersati Primo Modulo PL_Type/LiquidazioneImposte/AccontoAddCom2012 Addizionali_Type/AccontoAddCom2012 Addizionali_Type/AccontoAddCom2012Certif Acconti Irpef Anno Imposta_Type/AccontoAddComunale Acconti Irpef Anno Imposta_Type/AccontoAddComunaleF24 Cedolare Secca_Type/AccontoCedolare2011 Addizionali_Type/AddComCertif</p>

[Addizionali Type/AddComDovuta Ritenute Acconti Sospesi Type/AddComunalelrpef](#)
[Eccedenze Type/AddComunalelrpef Elemento Integrativo Type/AddComunalelrpef](#)
[Eccedenze Type/AddComunalelrpefF24 Altre Ritenute Type/AddizionaleComunale](#)
[Altre Ritenute Type/AddizionaleRegionale Elemento Integrativo Type/AddizionaleRegionalelrpef](#)
[Addizionali Type/AddRegCertif Addizionali Type/AddRegDovuta](#)
[Ritenute Acconti Sospesi Type/AddRegionalelrpef Eccedenze Type/AddRegionalelrpef](#)
[Altre Ritenute Type/AddRegionalelrpefAttivitaSport Eccedenze Type/AddRegionalelrpefCompF24](#)
[Altre Ritenute Type/AddRegionalelrpefLavoriSoc Utili Riepilogo Redditi Type/Agrari](#)
[Detrazione Crediti Type/AltreDetrazioni Altre Ritenute Type/AltreRitenutelrpef](#)
[Riepilogo Redditi Type/AltriRedditi Crediti Imposta Redditi Esteri Type/Anno](#)
[Incremento Produttivita Type/Art51Ordinaria Incremento Produttivita Type/Art51Sostitutiva](#)
[Detrazioni Type/AssicurazioneVita Detrazioni Type/AssistenzaPersonale](#)
[Detrazioni Type/AttivitaSportiveRagazzi Detrazioni Modulo Type/AttivitaSportiveRagazzi](#)
[FabbricatoOrd Type/CanoneLocazione Terreno Type/CanoneVincolistico](#)
[Crediti Imposta Fabbicati Type/CanoniLocazioneNonPercepiti](#)
[Cedolare Secca Type/CedolareDovuta Ritenute Acconti Sospesi Type/CedolareSecca](#)
[Elemento Integrativo Type/CedolareSecca Dati F24 Imu Type/CodAddReg](#)
[Dati F24 Imu Type/CodiceAddCom Imposta Lorda Type/CompensiAttSport](#)
[Ritenute Acconti Sospesi Type/ContribSolidarieta](#)
[Primo Modulo Lavoro Dip Type/ContribSolidarietaRiduzione](#)
[Primo Modulo Lavoro Dip Type/ContribSolidarietaTrattenuto Deduzioni Type/ContributiColf](#)
[Deduzioni Type/ContributiPrevAss Contributo Solidarieta Type/ContributoCertificaz](#)
[Contributo Solidarieta Type/ContributoDovuto Imposta Netta Type/CredAbitazSisma](#)
[Imposta Netta Type/CredAltriSisma Imposta Netta Type/CredCanNonPerc](#)
[Imposta Netta Type/CredImpEstere Credito Stato Type/Credito Credito Type/Credito](#)
[Residuo Credito Compens Type/CreditoAnno](#)
[Crediti Imposta Fondi Pensione Type/CreditoAnno](#)
[Crediti Imposta Redditi Esteri Type/CreditoDichiarazioniPrecedenti Credito Type/CreditoF24](#)
[Detrazione Crediti Type/CreditoFondiPensione Detrazione Crediti Type/CreditoMediazioni](#)
[Detrazione Crediti Type/CreditoOccupazione Detrazione Crediti Type/CreditoPrimaCasa](#)
[Credito Type/CreditoRimborso Imposta Lorda Type/DeduzAbPrinc](#)
[Detrazione Crediti Type/DetrazioneAltriRedditi](#)
[Detrazione Crediti Type/DetrazioneCanoniLocazione Detrazione Crediti Type/DetrazioneConiuge](#)
[Detrazione Crediti Type/DetrazioneFamiliari Detrazione Crediti Type/DetrazioneFigli](#)
[Detrazione Crediti Type/DetrazioneLavDip Detrazione Crediti Type/DetrazioneOneri](#)
[Detrazione Crediti Type/DetrazionePens Detrazione Crediti Type/DetrazioneRisparmioEnergetico](#)
[Detrazione Crediti Type/DetrazioneRistrutturazione Detrazione Crediti Type/DetrazioniSicurezza](#)
[Primo Modulo Crediti Imposta Type/CreditIncrementoOccupazione/DiCuiCompensatoF24](#)
[Primo Modulo Crediti Imposta Type/CreditImpostaFondiPensione/DiCuiCompensatoF24](#)
[Residuo Credito Compens Type/DiCuiCompensatoF24](#)
[Crediti Imposta Redditi Esteri Type/DiCuiStatoEstero Imposta Netta Type/Differenza](#)
[Riepilogo Redditi Type/Dominicali](#)
[Acconti Irpef Anno Imposta Type/EccedenzaAccontoCedolare](#)
[Acconti Irpef Anno Imposta Type/EccedenzaAccontoIrpef Addizionali Type/EccedenzaAddCom](#)
[Addizionali Type/EccedenzaAddReg Imposta Netta Type/Eccedenzalrpef](#)
[Deduzioni Type/ErogazioniIstituzioniReligiose](#)
[Contributi Previdenza Complementare Type/EsclusiDalSostituto](#)
[Riepilogo Redditi Type/Fabbicati Familiari Type/PrimoModulo/FigliResEsteri](#)
[Familiari PrimoModulo Type/FigliResEsteri Giorni Percentuale Type/Giorni](#)
[FabbricatoOrd Type/GiorniPossesso FabbricatoOrd Type/IciDovuta Addizionali Type/Imponibile](#)
[Riepilogo Redditi Type/ImponibileCedolare Riepilogo Redditi Type/ImponibileCedolareAgevolato](#)
[Riepilogo Redditi Type/ImponibileCedolareOrdinario](#)
[Contributo Solidarieta Type/ImponibileContributo Altri Oneri Type/Importo](#)
[Assegno Coniuge Type/Importo Spese Rateizzate Anni Precedenti Type/Importo](#)
[ICI Type/Importo Annotazioni Prospetto Type/Importo Altre Spese Type/Importo](#)
[Altre Detrazioni Type/Importo Spese Rateizzate Type/Importo](#)
[Dati F24 Imu Type/ImportoAddCom Dati F24 Imu Type/ImportoAddReg](#)
[Dati F24 Imu Type/ImportoCedolare Importo 730-4/ImportoConiuge](#)
[Debito Type/ImportoDaTrattenere Importo 730-4/ImportoDichiarante](#)
[Imposta Lorda Type/ImportoImpostaLorda Imposta Netta Type/ImportoImpostaNetta](#)
[Incremento Produttivita Type/ImportoImpostaSostitutiva Dati F24 Imu Type/ImportoIrpef](#)
[Casella Acconto Type/ImportoMisuralInferiore Redditi Ritenute Type/ImportoRedditi](#)
[Altri Redditi Ass Lavd Type/ImportoRedditoAssimilato Documento 730-4/DatiContabili730-](#)
[4/Ordinario 730-4/Conguaglio/ImportoRimborsare](#)
[Documento 730 Type/Conguaglio/ImportoRimborsato Redditi Ritenute Type/ImportoRitenute](#)
[Redditi Ritenute Spese Type/ImportoSpese](#)
[Incremento Produttivita Type/ImportoTassazOrdinaria Importo 730-4/ImportoTotale](#)
[Documento 730-4/DatiContabili730-4/Ordinario 730-4/Conguaglio/ImportoTrattenere](#)
[Documento 730 Type/Conguaglio/ImportoTrattenutoLuglio](#)
[Documento 730 Type/Conguaglio/ImportoTrattenutoNovembre](#)

[Crediti Imposta Redditi Esteri Type/Imposta Lorda](#)
[Crediti Imposta Redditi Esteri Type/ImpostaEstera](#)
[Crediti Imposta Redditi Esteri Type/ImpostaNetta](#)
[Acconti Altri Dati Type/IncapientiDetrazioneFigli](#)
[Acconti Altri Dati Type/IncapientiDetrazioneLocazione Elemento Integrativo Type/Irpef](#)
[Ritenute Acconti Sospesi Type/Irpef Eccedenze Type/Irpef Eccedenze Type/IrpefCompF24](#)
[Altre Ritenute Type/IrpefLavoriSocialmenteUtili Detrazioni Type/Istruzione](#)
[Riepilogo Redditi Type/LavDip Dati F24 Imu Type/m730Totale Dati Familiare Type/Mesi](#)
[Dati Familiare Type/MesiMinore Annotazioni Prospetto Type/ModuloQuadro](#)
[Detrazioni Type/MutuiAbPrincipale Detrazioni Type/MutuiAgrari](#)
[Detrazioni Type/MutuiAltrimmobili Detrazioni Type/MutuiCostruzioneAbPrincipRecuperoEdilizio](#)
[Detrazioni Type/MutuiRecuperoEdilizio](#)
[Contributi Previdenza Complementare Type/NonEsclusiDalSostituto](#)
[Credito Type/NonRimborsabile Debito Type/NonVersare](#)
[Dati Registrazione Accatastamento Recupero Patrimonio Edilizio Type/NOrdImmobil](#)
[Dati Catastali Recupero Patrimonio Edilizio Type/NOrdImmobil](#)
[Intervento Recupero Patrimonio Edilizio Type/NOrdinImmobil](#)
[Firma Dichiarazione Type/NumeroModelli FabbriatoAgev Type/NumModuloRiferimento](#)
[Imposta Lorda Type/OneriDeducibili](#)
[Primo Modulo PL Type/LiquidazioneImposte/PrimaRataAccCedolare](#)
[Primo Modulo PL Type/LiquidazioneImposte/PrimaRataAccIrpef](#)
[Acconti Irpef Anno Imposta Type/PrimaRataAccontoCedolare](#)
[Acconti Irpef Anno Imposta Type/PrimaRataAccontoIrpef](#)
[Redditi Eredi Legatari Type/QuotaImposteSuccessioni](#)
[Fondo Pensione Dipendenti Pubblici Type/QuotaTFR Terreno Type/RedAgrario](#)
[Lavoro Dipendente Type/Reddito Altri Dati Type/RedditoAgevolazioniFiscali](#)
[Crediti Imposta Redditi Esteri Type/RedditoComplessivo](#)
[Imposta Lorda Type/RedditoComplessivo Crediti Imposta Redditi Esteri Type/RedditoEstero](#)
[Imposta Lorda Type/RedditoImponibile Redditi Eredi Legatari Type/RedditoTotale](#)
[Terreno Type/RedDominicale FabbriatoOrd Type/Rendita](#)
[Altri Dati Type/ResiduoCreditoFondiPensione Altri Dati Type/ResiduoCreditoMediazioni](#)
[Altri Dati Type/ResiduoCreditoOccupazione Altri Dati Type/ResiduoCreditoPrimaCasa](#)
[Altri Dati Type/ResiduoCreditoSisma](#)
[Primo Modulo Crediti Imposta Type/CreditiImpostaFondiPensione/ResiduoPrecedenteDichiarazione](#)
[Residuo Credito Compens Type/ResiduoPrecedenteDichiarazione](#)
[Primo Modulo Crediti Imposta Type/CreditoPrimaCasaSismaAbruzzo/ResiduoPrecedenteDichiarazione](#)
[Primo Modulo Crediti Imposta Type/CreditoIncrementoOccupazione/ResiduoPrecedenteDichiarazione](#)
[Imposta Netta Type/RestituzioneBonus Acconti Altri Dati Type/RestituzioneBonusFiscale](#)
[Acconti Altri Dati Type/RestituzioneBonusStraordinario](#)
[Annotazioni Prospetto Type/RigoQuadro Ritenute Lavoro Dip Type/RitAccAddComAnnoPres](#)
[Ritenute Lavoro Dip Type/RitAccAddComunale Ritenute Lavoro Dip Type/RitAddRegionale](#)
[Imposta Netta Type/Ritenute Incremento Produttivita Type/RitenuteImpostaSostitutiva](#)
[Ritenute Lavoro Dip Type/RitIrpef Ritenute Lavoro Dip Type/RitSaldoAddComunale](#)
[Primo Modulo PL Type/LiquidazioneImposte/SecondaRataAccCedolare](#)
[Primo Modulo PL Type/LiquidazioneImposte/SecondaRataAccIrpef](#)
[Acconti Irpef Anno Imposta Type/SecondaRataAccontoCedolare](#)
[Acconti Irpef Anno Imposta Type/SecondaRataAccontoIrpef](#)
[Primo Modulo Lavoro Dip Type/SicurezzaDetrazione Soglie Esenzione Type/SogliaEsenzione](#)
[Crediti Imposta Fondi Pensione Type/SommaReintegrata](#)
[Ritenute Acconti Sospesi Type/SostitutivaProduttivita Eccedenze Type/SostitutivaQuadroRT](#)
[Eccedenze Type/SostitutivaQuadroRTcompF24 Intervento Risparmio Energetico Type/Spesa](#)
[Intervento Recupero Patrimonio Edilizio Type/Spesa](#)
[Dati Altre Detrazioni Type/SpeseAcquistoMobiliElettTVPC](#)
[Detrazioni Type/SpeseDeterminatePatologie Detrazioni Type/SpeseFamNonACarico](#)
[Detrazioni Type/SpeseFunebri Deduzioni Type/SpesePortatoriHandicap](#)
[Detrazioni Type/SpeseSanitarie Detrazioni Type/SpeseSanitarieDisabili Credito Stato Type/Stato](#)
[Crediti Imposta Redditi Esteri Type/StatoEstero](#)
[Credito Immobiliare Sisma Abruzzo Type/TotaleCredito](#)
[Detrazione Crediti Type/TotaleDetrazioniCrediti Cred Imp Estero Type/TotCredito](#)
[Altri Dati Type/TotSpeseSanitarieRateizzate Detrazione Crediti Type/UlterioreDetrazioneFigli](#)
[Documento SCE Type/BanchePoste/NumProgPacco](#)
[Documento SCE Type/BanchePoste/NumSeqDicIntPacco Firma Revisore Type/Soggetto](#)
[Intestazione Type/TipoFornitore](#)
[Anno Anticipazione Fondo Pensione Type](#)
[Anno Patrimonio Edilizio Situazioni Particolari Type Anno Recupero Patrimonio Edilizio Type](#)
[Anno Risparmio Energetico Type Codice Altre Detrazioni Type Codice Altre Spese Type](#)
[Codice Altri Oneri Type Codice Carica Type Codice Spese Rateizzate Anni Precedenti Type](#)
[Codice Spese Rateizzate Type FabbriatoAgev Numero Rigo Type Mesi Type](#)
[Natura Giuridica Type Numero Rata Risparmi Energetico Type Numero Rate5o10 Type](#)

simpleType
s

	Numero RateDa2A5_Type Rate10_Type Rate3_Type Rate5_Type Rate Risparmio_Energetico_Type Rideterminazione_Rate_Type Ripart_Risparmio_Energetico_Type Situazione_Type Stato_Civile_Coniuge_Type Stato_Civile_Type Stato_Type Tipo_Fornitore_730_Type Tipo_Inquilino_Type Tipo_Reddito_Da1a12_Type Tipo_Reddito_Da1a8_Type Utilizzo_Fabbricato_Type						
facets	<table border="1"> <tr> <td>Kind</td> <td>Value</td> <td>annotation</td> </tr> <tr> <td>pattern</td> <td>[1-9]{1}[0-9]*</td> <td></td> </tr> </table>	Kind	Value	annotation	pattern	[1-9]{1}[0-9]*	
Kind	Value	annotation					
pattern	[1-9]{1}[0-9]*						
annotation	documentation Tipo semplice che identifica numeri naturali positivi con al massimo 16 cifre.						
source	<pre><xs:simpleType name="DatoNP_Type"> <xs:annotation> <xs:documentation>Tipo semplice che identifica numeri naturali positivi con al massimo 16 cifre.</xs:documentation> </xs:annotation> <xs:restriction base="xs:string"> <xs:pattern value="[1-9]{1}[0-9]*"/> </xs:restriction> </xs:simpleType></pre>						

simpleType DatoNU_Type

namespace	urn:www.agenziaentrate.gov.it:specificheTecniche:common:v2									
type	restriction of xs:string									
properties	base xs:string									
used by	element Impegno A Trasmettere Type/NumerolscrAlboCAF									
facets	<table border="1"> <tr> <td>Kind</td> <td>Value</td> <td>annotation</td> </tr> <tr> <td>maxLength</td> <td>16</td> <td></td> </tr> <tr> <td>pattern</td> <td>(\-[1-9] [1-9])[0-9]*</td> <td></td> </tr> </table>	Kind	Value	annotation	maxLength	16		pattern	(\-[1-9] [1-9])[0-9]*	
Kind	Value	annotation								
maxLength	16									
pattern	(\-[1-9] [1-9])[0-9]*									
annotation	documentation Tipo semplice che identifica numeri naturali positivi e negativi con al massimo 16 cifre.									
source	<pre><xs:simpleType name="DatoNU_Type"> <xs:annotation> <xs:documentation>Tipo semplice che identifica numeri naturali positivi e negativi con al massimo 16 cifre.</xs:documentation> </xs:annotation> <xs:restriction base="xs:string"> <xs:maxLength value="16"/> <xs:pattern value="(\-[1-9] [1-9])[0-9]*"/> </xs:restriction> </xs:simpleType></pre>									

simpleType DatoPC_Type

namespace	urn:www.agenziaentrate.gov.it:specificheTecniche:common:v2
type	restriction of xs:string
properties	base xs:string

used by	elements Soglie Esenzione Type/AliquotaAgevolata Dati Primo Figlio Type/PercDetraz Dati Familiare Type/PercDetraz Giorni Percentuale Type/Percentuale Terreno Type/PercPossesso FabbricatoOrd Type/PercPossesso Familiari Type/PrimoModulo/PercUlteriore Familiari PrimoModulo Type/PercUlteriore									
facets	<table border="1"> <thead> <tr> <th>Kind</th> <th>Value</th> <th>annotation</th> </tr> </thead> <tbody> <tr> <td>maxLength</td> <td>16</td> <td></td> </tr> <tr> <td>pattern</td> <td>[0-9]?[0-9](,\d{1,3})? 100(,0{1,3})?</td> <td></td> </tr> </tbody> </table>	Kind	Value	annotation	maxLength	16		pattern	[0-9]?[0-9](,\d{1,3})? 100(,0{1,3})?	
Kind	Value	annotation								
maxLength	16									
pattern	[0-9]?[0-9](,\d{1,3})? 100(,0{1,3})?									
annotation	documentation Tipo semplice che esprime una percentuale e dunque consente valori positivi non superiori a 100, con al massimo 2 cifre decimali. Il separatore decimale previsto è la virgola.									
source	<pre><xs:simpleType name="DatoPC_Type"> <xs:annotation> <xs:documentation>Tipo semplice che esprime una percentuale e dunque consente valori positivi non superiori a 100, con al massimo 2 cifre decimali. Il separatore decimale previsto è la virgola.</xs:documentation> </xs:annotation> <xs:restriction base="xs:string"> <xs:maxLength value="16"/> <xs:pattern value="[0-9]?[0- 9](,\d{1,3})? 100(,0{1,3})?" /> </xs:restriction> </xs:simpleType></pre>									

simpleType DatoPI_Type

namespace	urn:www.agenziaentrate.gov.it:specificheTecniche:common:v2									
type	restriction of xs:string									
properties	base xs:string									
facets	<table border="1"> <thead> <tr> <th>Kind</th> <th>Value</th> <th>annotation</th> </tr> </thead> <tbody> <tr> <td>length</td> <td>11</td> <td></td> </tr> <tr> <td>pattern</td> <td>[0-7][0-9]{10}</td> <td></td> </tr> </tbody> </table>	Kind	Value	annotation	length	11		pattern	[0-7][0-9]{10}	
Kind	Value	annotation								
length	11									
pattern	[0-7][0-9]{10}									
annotation	documentation Tipo semplice che identifica la partita IVA rispettandone i vincoli di struttura.									
source	<pre><xs:simpleType name="DatoPI_Type"> <xs:annotation> <xs:documentation>Tipo semplice che identifica la partita IVA rispettandone i vincoli di struttura. </xs:documentation> </xs:annotation> <xs:restriction base="xs:string"> <xs:length value="11"/> <xs:pattern value="[0-7][0-9]{10}" /> </xs:restriction> </xs:simpleType></pre>									

simpleType DatoQU_Type

namespace	urn:www.agenziaentrate.gov.it:specificheTecniche:common:v2
-----------	--

type	restriction of xs:string									
properties	base xs:string									
facets	<table border="1"> <tr> <td>Kind</td> <td>Value</td> <td>annotation</td> </tr> <tr> <td>maxLength</td> <td>16</td> <td></td> </tr> <tr> <td>pattern</td> <td colspan="2">^[0-9]+(\d{1,5})?</td> </tr> </table>	Kind	Value	annotation	maxLength	16		pattern	^[0-9]+(\d{1,5})?	
Kind	Value	annotation								
maxLength	16									
pattern	^[0-9]+(\d{1,5})?									
annotation	documentation Tipo semplice che identifica numeri positivi con al massimo 5 cifre decimali. La lunghezza massima prevista è di 16 caratteri, il separatore decimale previsto è la virgola.									
source	<pre><xs:simpleType name="DatoQU_Type"> <xs:annotation> <xs:documentation>Tipo semplice che identifica numeri positivi con al massimo 5 cifre decimali. La lunghezza massima prevista è di 16 caratteri, il separatore decimale previsto è la virgola.</xs:documentation> </xs:annotation> <xs:restriction base="xs:string"> <xs:maxLength value="16"/> <xs:pattern value="^[0-9]+(\d{1,5})?"/> </xs:restriction> </xs:simpleType></pre>									

simpleType **DatoTL_Type**

namespace	urn:www.agenziaentrate.gov.it:specificheTecniche:common:v2						
type	restriction of xs:string						
properties	base xs:string						
used by	elements Soggetto Fiscale Type/Fax Soggetto Fiscale Type/Telefono Dati Sottoscrittore Type/Telefono						
facets	<table border="1"> <tr> <td>Kind</td> <td>Value</td> <td>annotation</td> </tr> <tr> <td>pattern</td> <td colspan="2">[0-9]*</td> </tr> </table>	Kind	Value	annotation	pattern	[0-9]*	
Kind	Value	annotation					
pattern	[0-9]*						
annotation	documentation Tipo semplice che identifica un elemento di tipo telefono						
source	<pre><xs:simpleType name="DatoTL_Type"> <xs:annotation> <xs:documentation>Tipo semplice che identifica un elemento di tipo telefono</xs:documentation> </xs:annotation> <xs:restriction base="xs:string"> <xs:pattern value="[0-9]*/> </xs:restriction> </xs:simpleType></pre>						

simpleType **Casella_Quadro_Type**

namespace	urn:www.agenziaentrate.gov.it:specificheTecniche:sco:common:v2
type	restriction of DatoAN_Type
properties	base cm:DatoAN_Type

facets	Kind	Value	annotation
	pattern	[0-9A-Z-]{1}([0-9A-Z] \- \& _ s / ^ \(\))*	
	enumeration	0	
	enumeration	1	
	enumeration	2	
	enumeration	3	
source	<pre> <xs:simpleType name="Casella_Quadro_Type"> <xs:restriction base="cm:DatoAN_Type"> <xs:enumeration value="0"/> <xs:enumeration value="1"/> <xs:enumeration value="2"/> <xs:enumeration value="3"/> </xs:restriction> </xs:simpleType> </pre>		

simpleType Codice_Carica_Type

namespace	urn:www.agenziaentrate.gov.it:specificheTecniche:sco:common:v2		
type	restriction of DatoNP_Type		
properties	base cm:DatoNP_Type		
used by	element Dati_Sottoscrittore_Type/CodiceCarica		
facets	Kind	Value	annotation
	pattern	[1-9]{1}[0-9]*	
	enumeration	1	documentation Rappresentante legale, negoziale o di fatto, socio amministratore
	enumeration	2	documentation <![CDATA[Rappresentante di minore, inabilitato o interdetto, amministratore di sostegno, ovvero curatore dell'eredità giacente, amministratore dell'eredità]]>
	enumeration	3	documentation Curatore fallimentare
	enumeration	4	documentation Commissario liquidatore
	enumeration	5	documentation Commissario giudiziale
	enumeration	6	documentation <![CDATA[Rappresentante fiscale di soggetto non residente]]>
	enumeration	7	documentation Erede
	enumeration	8	documentation <![CDATA[Liquidatore - liquidazione volontaria]]>
	enumeration	9	documentation <![CDATA[Soggetto tenuto a presentare dichiarazione in caso di operazioni straordinarie]]>
	enumeration	10	documentation <![CDATA[Rappresentante fiscale di soggetto non residente con le limitazioni di cui all'art. 44, comma 3, del D.L. n.331/1993]]>
	enumeration	11	documentation <![CDATA[Soggetto esercente l'attività tutoria del minore o interdetto in relazione alla funzione istituzionale rivestita]]>
	enumeration	12	documentation <![CDATA[Liquidatore - liquidazione volontaria di ditta individuale periodo ante messa in liquidazione]]>
	enumeration	13	documentation Amministratore di condominio
enumeration	14	documentation <![CDATA[Soggetto che sottoscrive la dichiarazione per conto di una pubblica	

	enumeration 15	amministrazione]]> documentation <![CDATA[Commissario liquidatore di una pubblica amministrazione]]>
annotation	documentation Tabella generale dei codici carica	
source	<pre> <xs:simpleType name="Codice_Carica_Type"> <xs:annotation> <xs:documentation>Tabella generale dei codici carica</xs:documentation> </xs:annotation> <xs:restriction base="cm:DatoNP_Type"> <xs:enumeration value="1"> <xs:annotation> <xs:documentation>Rappresentante legale, negoziante o di fatto, socio amministratore</xs:documentation> </xs:annotation> </xs:enumeration> <xs:enumeration value="2"> <xs:annotation> <xs:documentation><![CDATA[Rappresentante di minore, inabilitato o interdetto, amministratore di sostegno, ovvero curatore dell'eredità giacente, amministratore dell'eredità]]></xs:documentation> </xs:annotation> </xs:enumeration> <xs:enumeration value="3"> <xs:annotation> <xs:documentation>Curatore fallimentare</xs:documentation> </xs:annotation> </xs:enumeration> <xs:enumeration value="4"> <xs:annotation> <xs:documentation>Commissario liquidatore</xs:documentation> </xs:annotation> </xs:enumeration> <xs:enumeration value="5"> <xs:annotation> <xs:documentation>Commissario giudiziale</xs:documentation> </xs:annotation> </xs:enumeration> <xs:enumeration value="6"> <xs:annotation> <xs:documentation><![CDATA[Rappresentante fiscale di soggetto non residente]]></xs:documentation> </xs:annotation> </xs:enumeration> </xs:restriction> </xs:simpleType> </pre>	

```
</xs:enumeration>
<xs:enumeration value="7">
  <xs:annotation>
    <xs:documentation>Erede</xs:documentation>
  </xs:annotation>
</xs:enumeration>
<xs:enumeration value="8">
  <xs:annotation>
    <xs:documentation><![CDATA[Liquidatore - liquidazione
volontaria]]></xs:documentation>
  </xs:annotation>
</xs:enumeration>
<xs:enumeration value="9">
  <xs:annotation>
    <xs:documentation><![CDATA[Soggetto tenuto a
presentare dichiarazione in caso di operazioni
straordinarie]]></xs:documentation>
  </xs:annotation>
</xs:enumeration>
<xs:enumeration value="10">
  <xs:annotation>
    <xs:documentation><![CDATA[Rappresentante fiscale di
soggetto non residente con le limitazioni di cui all'art. 44,
comma 3, del D.L. n.331/1993]]></xs:documentation>
  </xs:annotation>
</xs:enumeration>
<xs:enumeration value="11">
  <xs:annotation>
    <xs:documentation><![CDATA[Soggetto esercente
l'attività tutoria del minore o interdetto in relazione alla
funzione istituzionale rivestita]]></xs:documentation>
  </xs:annotation>
</xs:enumeration>
<xs:enumeration value="12">
  <xs:annotation>
    <xs:documentation><![CDATA[Liquidatore - liquidazione
volontaria di ditta individuale periodo ante messa in
liquidazione]]></xs:documentation>
  </xs:annotation>
</xs:enumeration>
<xs:enumeration value="13">
  <xs:annotation>
    <xs:documentation>Amministratore di
condominio</xs:documentation>
  </xs:annotation>
</xs:enumeration>
<xs:enumeration value="14">
```

	<pre> <xs:annotation> <xs:documentation><![CDATA[Soggetto che sottoscrive la dichiarazione per conto di una pubblica amministrazione]]></xs:documentation> </xs:annotation> </xs:enumeration> <xs:enumeration value="15"> <xs:annotation> <xs:documentation><![CDATA[Commissario liquidatore di una pubblica amministrazione]]></xs:documentation> </xs:annotation> </xs:enumeration> </xs:restriction> </xs:simpleType> </pre>
--	---

simpleType Codice_Regione_Type

namespace	urn:www.agenziaentrate.gov.it:specificheTecniche:sco:common:v2																																																																					
type	restriction of DatoAN_Type																																																																					
properties	base cm:DatoAN_Type																																																																					
used by	elements Eccedenze_Type/CodiceRegione ImportiTrattenere730-4/AddRegTrattenere/CodiceRegione Importi_Rimborsare730-4_Type/AddRegRimborsare/CodiceRegione																																																																					
facets	<table border="0"> <thead> <tr> <th>Kind</th> <th>Value</th> <th>annotation</th> </tr> </thead> <tbody> <tr> <td>pattern</td> <td>[0-9A-Z-]{1}([0-9A-Z] [- \. &#x26; _ s / ^ \\())*</td> <td></td> </tr> <tr> <td>enumeration</td> <td>1</td> <td></td> </tr> <tr> <td>enumeration</td> <td>2</td> <td></td> </tr> <tr> <td>enumeration</td> <td>3</td> <td></td> </tr> <tr> <td>enumeration</td> <td>4</td> <td></td> </tr> <tr> <td>enumeration</td> <td>5</td> <td></td> </tr> <tr> <td>enumeration</td> <td>6</td> <td></td> </tr> <tr> <td>enumeration</td> <td>7</td> <td></td> </tr> <tr> <td>enumeration</td> <td>8</td> <td></td> </tr> <tr> <td>enumeration</td> <td>9</td> <td></td> </tr> <tr> <td>enumeration</td> <td>10</td> <td></td> </tr> <tr> <td>enumeration</td> <td>11</td> <td></td> </tr> <tr> <td>enumeration</td> <td>12</td> <td></td> </tr> <tr> <td>enumeration</td> <td>13</td> <td></td> </tr> <tr> <td>enumeration</td> <td>14</td> <td></td> </tr> <tr> <td>enumeration</td> <td>15</td> <td></td> </tr> <tr> <td>enumeration</td> <td>16</td> <td></td> </tr> <tr> <td>enumeration</td> <td>17</td> <td></td> </tr> <tr> <td>enumeration</td> <td>18</td> <td></td> </tr> <tr> <td>enumeration</td> <td>19</td> <td></td> </tr> <tr> <td>enumeration</td> <td>20</td> <td></td> </tr> <tr> <td>enumeration</td> <td>21</td> <td></td> </tr> </tbody> </table>	Kind	Value	annotation	pattern	[0-9A-Z-]{1}([0-9A-Z] [- \. & _ s / ^ \\())*		enumeration	1		enumeration	2		enumeration	3		enumeration	4		enumeration	5		enumeration	6		enumeration	7		enumeration	8		enumeration	9		enumeration	10		enumeration	11		enumeration	12		enumeration	13		enumeration	14		enumeration	15		enumeration	16		enumeration	17		enumeration	18		enumeration	19		enumeration	20		enumeration	21	
Kind	Value	annotation																																																																				
pattern	[0-9A-Z-]{1}([0-9A-Z] [- \. & _ s / ^ \\())*																																																																					
enumeration	1																																																																					
enumeration	2																																																																					
enumeration	3																																																																					
enumeration	4																																																																					
enumeration	5																																																																					
enumeration	6																																																																					
enumeration	7																																																																					
enumeration	8																																																																					
enumeration	9																																																																					
enumeration	10																																																																					
enumeration	11																																																																					
enumeration	12																																																																					
enumeration	13																																																																					
enumeration	14																																																																					
enumeration	15																																																																					
enumeration	16																																																																					
enumeration	17																																																																					
enumeration	18																																																																					
enumeration	19																																																																					
enumeration	20																																																																					
enumeration	21																																																																					
source	<pre> <xs:simpleType name="Codice_Regione_Type"> <xs:restriction base="cm:DatoAN_Type"> </pre>																																																																					

```

<xs:enumeration value="1"/>
<xs:enumeration value="2"/>
<xs:enumeration value="3"/>
<xs:enumeration value="4"/>
<xs:enumeration value="5"/>
<xs:enumeration value="6"/>
<xs:enumeration value="7"/>
<xs:enumeration value="8"/>
<xs:enumeration value="9"/>
<xs:enumeration value="10"/>
<xs:enumeration value="11"/>
<xs:enumeration value="12"/>
<xs:enumeration value="13"/>
<xs:enumeration value="14"/>
<xs:enumeration value="15"/>
<xs:enumeration value="16"/>
<xs:enumeration value="17"/>
<xs:enumeration value="18"/>
<xs:enumeration value="19"/>
<xs:enumeration value="20"/>
<xs:enumeration value="21"/>
</xs:restriction>
</xs:simpleType>

```

simpleType **Natura_Giuridica_Type**

namespace	urn:www.agenziaentrate.gov.it:specificheTecniche:sco:common:v2		
type	restriction of DatoNP_Type		
properties	base	cm:DatoNP_Type	
used by	element	Soggetti Diversi Da PF Type/NaturaGiuridica	
facets	Kind	Value	annotation
	pattern	[1-9]{1}[0-9]*	
	enumeration	1	documentation <![CDATA[Società in accomandita per azioni]]>
	enumeration	2	documentation <![CDATA[Società a responsabilità limitata]]>
	enumeration	3	documentation <![CDATA[Società per azioni]]>
	enumeration	4	documentation <![CDATA[Società cooperative e loro consorzi iscritti nei registri prefettizi e nello schedario della cooperazione]]>
	enumeration	5	documentation <![CDATA[Altre società cooperative]]>
	enumeration	6	documentation <![CDATA[Mutue assicuratrici]]>
	enumeration	7	documentation <![CDATA[Consorzi con personalità giuridica]]>
	enumeration	8	documentation <![CDATA[Associazioni riconosciute]]>
	enumeration	9	documentation <![CDATA[Fondazioni]]>
	enumeration	10	documentation <![CDATA[Altri enti ed istituti con personalità giuridica]]>

enumeration	11	documentation <![CDATA[Consorsi senza personalità giuridica]]>
enumeration	12	documentation <![CDATA[Associazioni non riconosciute e comitati]]>
enumeration	13	documentation <![CDATA[Altre organizzazioni di persone o beni senza personalità giuridica, escluse le comunioni]]>
enumeration	14	documentation <![CDATA[Enti pubblici economici]]>
enumeration	15	documentation <![CDATA[Enti pubblici non economici]]>
enumeration	16	documentation <![CDATA[Casse mutue e fondi previdenza, assistenza, pensioni o simili con o senza personalità giuridica]]>
enumeration	17	documentation <![CDATA[Opere pie e società di mutuo soccorso]]>
enumeration	18	documentation <![CDATA[Enti ospedalieri]]>
enumeration	19	documentation <![CDATA[Enti ed istituti di previdenza e di assistenza sociale]]>
enumeration	20	documentation <![CDATA[Aziende autonome di cura, soggiorno e turismo]]>
enumeration	21	documentation <![CDATA[Aziende regionali, provinciali, comunali e loro consorzi]]>
enumeration	22	documentation <![CDATA[Società, organizzazioni ed enti costituiti all'estero non altrimenti classificabili con sede dell'amministrazione od oggetto principale in Italia]]>
enumeration	23	documentation <![CDATA[Società semplici ed equiparate, art.5, comma 3 lett.b del Tuir]]>
enumeration	24	documentation <![CDATA[Società in nome collettivo ed equiparate ai sensi dell'art. 5, comma 3, lett. b, del TUIR]]>
enumeration	25	documentation <![CDATA[Società in accomandita semplice]]>
enumeration	26	documentation <![CDATA[Società di armamento]]>
enumeration	27	documentation <![CDATA[Associazioni fra artisti e professionisti]]>
enumeration	28	documentation <![CDATA[Aziende coniugali]]>
enumeration	29	documentation <![CDATA[GEIE (Gruppi europei di interesse economico)]]>
enumeration	30	documentation <![CDATA[Soggetti non residenti - Società semplici, irregolari e di fatto]]>
enumeration	31	documentation <![CDATA[Soggetti non residenti - Società in nome collettivo]]>
enumeration	32	documentation <![CDATA[Soggetti non residenti - Società in accomandita semplice]]>
enumeration	33	documentation <![CDATA[Soggetti non residenti - Società di armamento]]>
enumeration	34	documentation <![CDATA[Soggetti non residenti - Associazioni fra professionisti]]>
enumeration	35	documentation <![CDATA[Soggetti non residenti - Società in accomandita per azioni]]>
enumeration	36	documentation <![CDATA[Soggetti non residenti - Società a responsabilità limitata]]>
enumeration	37	documentation <![CDATA[Soggetti non residenti - Società per azioni]]>
enumeration	38	documentation <![CDATA[Soggetti non residenti - Consorzi]]>
enumeration	39	documentation <![CDATA[Soggetti non residenti - Altri enti ed istituti]]>
enumeration	40	documentation <![CDATA[Soggetti non residenti - Associazioni riconosciute, non riconosciute e di fatto]]>
enumeration	41	documentation <![CDATA[Soggetti non residenti - Fondazioni]]>
enumeration	42	documentation <![CDATA[Soggetti non residenti - Opere pie e società di mutuo soccorso]]>

	enumeration 43	documentation <![CDATA[Soggetti non residenti - Altre organizzazioni di persone e di beni]]>
	enumeration 44	documentation <![CDATA[Soggetti non residenti - Trust]]>
	enumeration 50	documentation <![CDATA[Società per azioni, aziende speciali e consorzi artt. 31, 113, 114, 115 e 116 del D.Lgs 18/8/2000 n.267]]>
	enumeration 51	documentation <![CDATA[Condomini]]>
	enumeration 52	documentation <![CDATA[Depositi IVA]]>
	enumeration 53	documentation <![CDATA[Società sportive dilettantistiche costituite in società di capitali senza fini di lucro]]>
	enumeration 54	documentation <![CDATA[Trust]]>
	enumeration 55	documentation <![CDATA[Amministrazioni pubbliche]]>
	enumeration 56	documentation <![CDATA[Fondazioni bancarie]]>
	enumeration 57	documentation <![CDATA[Società europea]]>
	enumeration 58	documentation <![CDATA[Società cooperativa europea]]>
annotation		documentation Tabella generale classificazione natura giuridica
source		<pre> <xs:simpleType name="Natura_Giuridica_Type"> <xs:annotation> <xs:documentation>Tabella generale classificazione natura giuridica</xs:documentation> </xs:annotation> <xs:restriction base="cm:DatoNP_Type"> <xs:enumeration value="1"> <xs:annotation> <xs:documentation><![CDATA[Società in accomandita per azioni]]></xs:documentation> </xs:annotation> </xs:enumeration> <xs:enumeration value="2"> <xs:annotation> <xs:documentation><![CDATA[Società a responsabilità limitata]]></xs:documentation> </xs:annotation> </xs:enumeration> <xs:enumeration value="3"> <xs:annotation> <xs:documentation><![CDATA[Società per azioni]]></xs:documentation> </xs:annotation> </xs:enumeration> <xs:enumeration value="4"> <xs:annotation> <xs:documentation><![CDATA[Società cooperative e loro consorzi iscritti nei registri prefettizi e nello schedario della cooperazione]]></xs:documentation> </xs:annotation> </xs:enumeration> </xs:restriction> </xs:simpleType> </pre>

```
</xs:annotation>
</xs:enumeration>
<xs:enumeration value="5">
  <xs:annotation>
    <xs:documentation><![CDATA[Altre società
cooperative]]></xs:documentation>
  </xs:annotation>
</xs:enumeration>
<xs:enumeration value="6">
  <xs:annotation>
    <xs:documentation><![CDATA[Mutue
assicuratrici]]></xs:documentation>
  </xs:annotation>
</xs:enumeration>
<xs:enumeration value="7">
  <xs:annotation>
    <xs:documentation><![CDATA[Consorzi con personalità
giuridica]]></xs:documentation>
  </xs:annotation>
</xs:enumeration>
<xs:enumeration value="8">
  <xs:annotation>
    <xs:documentation><![CDATA[Associazioni
riconosciute]]></xs:documentation>
  </xs:annotation>
</xs:enumeration>
<xs:enumeration value="9">
  <xs:annotation>
<xs:documentation><![CDATA[Fondazioni]]></xs:documentation>
  </xs:annotation>
</xs:enumeration>
<xs:enumeration value="10">
  <xs:annotation>
    <xs:documentation><![CDATA[Altri enti ed istituti con
personalità giuridica]]></xs:documentation>
  </xs:annotation>
</xs:enumeration>
<xs:enumeration value="11">
  <xs:annotation>
    <xs:documentation><![CDATA[Consorsi senza personalità
giuridica]]></xs:documentation>
  </xs:annotation>
</xs:enumeration>
<xs:enumeration value="12">
  <xs:annotation>
    <xs:documentation><![CDATA[Associazioni non
```



```
</xs:enumeration>
<xs:enumeration value="20">
  <xs:annotation>
    <xs:documentation><![CDATA[Aziende autonome di cura,
soggiorno e turismo]]></xs:documentation>
  </xs:annotation>
</xs:enumeration>
<xs:enumeration value="21">
  <xs:annotation>
    <xs:documentation><![CDATA[Aziende regionali,
provinciali, comunali e loro consorzi]]></xs:documentation>
  </xs:annotation>
</xs:enumeration>
<xs:enumeration value="22">
  <xs:annotation>
    <xs:documentation><![CDATA[Società, organizzazioni ed
enti costituiti all'estero non altrimenti classificabili con
sede dell'amministrazione od oggetto principale in
Italia]]></xs:documentation>
  </xs:annotation>
</xs:enumeration>
<xs:enumeration value="23">
  <xs:annotation>
    <xs:documentation><![CDATA[Società semplici ed
equiparate, art.5, comma 3 lett.b del
Tuir]]></xs:documentation>
  </xs:annotation>
</xs:enumeration>
<xs:enumeration value="24">
  <xs:annotation>
    <xs:documentation><![CDATA[Società in nome collettivo
ed equiparate ai sensi dell'art. 5, comma 3, lett. b, del
TUIR]]></xs:documentation>
  </xs:annotation>
</xs:enumeration>
<xs:enumeration value="25">
  <xs:annotation>
    <xs:documentation><![CDATA[Società in accomandita
semplice]]></xs:documentation>
  </xs:annotation>
</xs:enumeration>
<xs:enumeration value="26">
  <xs:annotation>
    <xs:documentation><![CDATA[Società di
armamento]]></xs:documentation>
  </xs:annotation>
</xs:enumeration>
```

```
<xs:enumeration value="27">
  <xs:annotation>
    <xs:documentation><![CDATA[Associazioni fra artisti e
professionisti]]></xs:documentation>
  </xs:annotation>
</xs:enumeration>
<xs:enumeration value="28">
  <xs:annotation>
    <xs:documentation><![CDATA[Aziende
coniugali]]></xs:documentation>
  </xs:annotation>
</xs:enumeration>
<xs:enumeration value="29">
  <xs:annotation>
    <xs:documentation><![CDATA[GEIE (Gruppi europei di
interesse economico)]]></xs:documentation>
  </xs:annotation>
</xs:enumeration>
<xs:enumeration value="30">
  <xs:annotation>
    <xs:documentation><![CDATA[Soggetti non residenti -
Società semplici, irregolari e di fatto]]></xs:documentation>
  </xs:annotation>
</xs:enumeration>
<xs:enumeration value="31">
  <xs:annotation>
    <xs:documentation><![CDATA[Soggetti non residenti -
Società in nome collettivo]]></xs:documentation>
  </xs:annotation>
</xs:enumeration>
<xs:enumeration value="32">
  <xs:annotation>
    <xs:documentation><![CDATA[Soggetti non residenti -
Società in accomandita semplice]]></xs:documentation>
  </xs:annotation>
</xs:enumeration>
<xs:enumeration value="33">
  <xs:annotation>
    <xs:documentation><![CDATA[Soggetti non residenti -
Società di armamento]]></xs:documentation>
  </xs:annotation>
</xs:enumeration>
<xs:enumeration value="34">
  <xs:annotation>
    <xs:documentation><![CDATA[Soggetti non residenti -
Associazioni fra professionisti]]></xs:documentation>
  </xs:annotation>
</xs:enumeration>
```

```
</xs:enumeration>
<xs:enumeration value="35">
  <xs:annotation>
    <xs:documentation><![CDATA[Soggetti non residenti -
Società in accomandita per azioni]]></xs:documentation>
  </xs:annotation>
</xs:enumeration>
<xs:enumeration value="36">
  <xs:annotation>
    <xs:documentation><![CDATA[Soggetti non residenti -
Società a responsabilità limitata]]></xs:documentation>
  </xs:annotation>
</xs:enumeration>
<xs:enumeration value="37">
  <xs:annotation>
    <xs:documentation><![CDATA[Soggetti non residenti -
Società per azioni]]></xs:documentation>
  </xs:annotation>
</xs:enumeration>
<xs:enumeration value="38">
  <xs:annotation>
    <xs:documentation><![CDATA[Soggetti non residenti -
ConSORZI]]></xs:documentation>
  </xs:annotation>
</xs:enumeration>
<xs:enumeration value="39">
  <xs:annotation>
    <xs:documentation><![CDATA[Soggetti non residenti -
Altri enti ed istituti]]></xs:documentation>
  </xs:annotation>
</xs:enumeration>
<xs:enumeration value="40">
  <xs:annotation>
    <xs:documentation><![CDATA[Soggetti non residenti -
Associazioni riconosciute, non riconosciute e di
fatto]]></xs:documentation>
  </xs:annotation>
</xs:enumeration>
<xs:enumeration value="41">
  <xs:annotation>
    <xs:documentation><![CDATA[Soggetti non residenti -
Fondazioni]]></xs:documentation>
  </xs:annotation>
</xs:enumeration>
<xs:enumeration value="42">
  <xs:annotation>
    <xs:documentation><![CDATA[Soggetti non residenti -
```

```

Opere pie e società di mutuo soccorso]]></xs:documentation>
  </xs:annotation>
</xs:enumeration>
<xs:enumeration value="43">
  <xs:annotation>
    <xs:documentation><![CDATA[Soggetti non residenti -
Altre organizzazioni di persone e di
beni]]></xs:documentation>
  </xs:annotation>
</xs:enumeration>
<xs:enumeration value="44">
  <xs:annotation>
    <xs:documentation><![CDATA[Soggetti non residenti -
Trust]]></xs:documentation>
  </xs:annotation>
</xs:enumeration>
<xs:enumeration value="50">
  <xs:annotation>
    <xs:documentation><![CDATA[Società per azioni,
aziende speciali e consorzi artt. 31, 113, 114, 115 e 116 del
D.Lgs 18/8/2000 n.267]]></xs:documentation>
  </xs:annotation>
</xs:enumeration>
<xs:enumeration value="51">
  <xs:annotation>

<xs:documentation><![CDATA[Condomini]]></xs:documentation>
  </xs:annotation>
</xs:enumeration>
<xs:enumeration value="52">
  <xs:annotation>
    <xs:documentation><![CDATA[Depositi
IVA]]></xs:documentation>
  </xs:annotation>
</xs:enumeration>
<xs:enumeration value="53">
  <xs:annotation>
    <xs:documentation><![CDATA[Società sportive
dilettantistiche costituite in società di capitali senza fini
di lucro]]></xs:documentation>
  </xs:annotation>
</xs:enumeration>
<xs:enumeration value="54">
  <xs:annotation>

<xs:documentation><![CDATA[Trust]]></xs:documentation>
  </xs:annotation>

```

	<pre> </xs:enumeration> <xs:enumeration value="55"> <xs:annotation> <xs:documentation><![CDATA[Amministrazioni pubbliche]]></xs:documentation> </xs:annotation> </xs:enumeration> <xs:enumeration value="56"> <xs:annotation> <xs:documentation><![CDATA[Fondazioni bancarie]]></xs:documentation> </xs:annotation> </xs:enumeration> <xs:enumeration value="57"> <xs:annotation> <xs:documentation><![CDATA[Società europea]]></xs:documentation> </xs:annotation> </xs:enumeration> <xs:enumeration value="58"> <xs:annotation> <xs:documentation><![CDATA[Società cooperativa europea]]></xs:documentation> </xs:annotation> </xs:enumeration> </xs:restriction> </xs:simpleType> </pre>
--	---

simpleType Sesso_Type

namespace	urn:www.agenziaentrare.gov.it:specificheTecniche:sco:common:v2		
type	restriction of DatoAN_Type		
properties	base	cm:DatoAN_Type	
used by	elements	Dati_Nascita_PF_Type/Sesso DatiAnagraficiScelte_Type/Sesso Dati_Anagrafici_Type/Sesso	
facets	Kind	Value	annotation
	pattern	[0-9A-Z-]{1}([0-9A-Z] ' \" & , \" / ° ^\ \\ ())*)	
	enumeration	M	documentation <![CDATA[Maschio]]>
	enumeration	F	documentation <![CDATA[Femmina]]>
source	<pre> <xs:simpleType name="Sesso_Type"> <xs:restriction base="cm:DatoAN_Type"> <xs:enumeration value="M"> <xs:annotation> <xs:documentation><![CDATA[Maschio]]></xs:documentation> </xs:annotation> </xs:enumeration> <xs:enumeration value="F"> <xs:annotation> <xs:documentation><![CDATA[Femmina]]></xs:documentation> </xs:annotation> </xs:enumeration> </xs:restriction> </xs:simpleType> </pre>		

	<pre> </xs:enumeration> <xs:enumeration value="F"> <xs:annotation> <xs:documentation><![CDATA[Femmina]]></xs:documentation> </xs:annotation> </xs:enumeration> </xs:restriction> </xs:simpleType> </pre>
--	---

simpleType **Situazione_Type**

namespace	urn:www.agenziaentrate.gov.it:specificheTecniche:sco:common:v2																											
type	restriction of DatoNP_Type																											
properties	base cm:DatoNP_Type																											
used by	element Soggetti Diversi Da PF Type/Situazione																											
facets	<table border="1"> <thead> <tr> <th>Kind</th> <th>Value</th> <th>annotation</th> </tr> </thead> <tbody> <tr> <td>pattern</td> <td>[1-9]{1}[0-9]*</td> <td></td> </tr> <tr> <td>enumeration</td> <td>1</td> <td>documentation <![CDATA[Periodo di imposta che inizia dalla data di messa in liquidazione per cessazione di attività, per fallimento o per liquidazione coatta amministrativa]]></td> </tr> <tr> <td>enumeration</td> <td>2</td> <td>documentation <![CDATA[Periodi di imposta successivi a quello di dichiarazione di fallimento o di messa in liquidazione]]></td> </tr> <tr> <td>enumeration</td> <td>3</td> <td>documentation <![CDATA[Periodo d'imposta in cui ha avuto termine la liquidazione per cessazione di attività, per fallimento o per liquidazione coatta amministrativa]]></td> </tr> <tr> <td>enumeration</td> <td>4</td> <td>documentation <![CDATA[Periodo di imposta in cui si è verificata l'estinzione del soggetto per fusione o incorporazione]]></td> </tr> <tr> <td>enumeration</td> <td>5</td> <td>documentation <![CDATA[Periodo d'imposta in cui è avvenuta la trasformazione da società soggetta ad IRES in società non soggetta ad IRES o viceversa]]></td> </tr> <tr> <td>enumeration</td> <td>6</td> <td>documentation <![CDATA[Periodo normale d'imposta e periodo compreso tra l'inizio del periodo d'imposta e la data di messa in liquidazione]]></td> </tr> <tr> <td>enumeration</td> <td>7</td> <td>documentation <![CDATA[Periodo d'imposta in cui si è verificata l'estinzione del soggetto per scissione totale]]></td> </tr> </tbody> </table>	Kind	Value	annotation	pattern	[1-9]{1}[0-9]*		enumeration	1	documentation <![CDATA[Periodo di imposta che inizia dalla data di messa in liquidazione per cessazione di attività, per fallimento o per liquidazione coatta amministrativa]]>	enumeration	2	documentation <![CDATA[Periodi di imposta successivi a quello di dichiarazione di fallimento o di messa in liquidazione]]>	enumeration	3	documentation <![CDATA[Periodo d'imposta in cui ha avuto termine la liquidazione per cessazione di attività, per fallimento o per liquidazione coatta amministrativa]]>	enumeration	4	documentation <![CDATA[Periodo di imposta in cui si è verificata l'estinzione del soggetto per fusione o incorporazione]]>	enumeration	5	documentation <![CDATA[Periodo d'imposta in cui è avvenuta la trasformazione da società soggetta ad IRES in società non soggetta ad IRES o viceversa]]>	enumeration	6	documentation <![CDATA[Periodo normale d'imposta e periodo compreso tra l'inizio del periodo d'imposta e la data di messa in liquidazione]]>	enumeration	7	documentation <![CDATA[Periodo d'imposta in cui si è verificata l'estinzione del soggetto per scissione totale]]>
Kind	Value	annotation																										
pattern	[1-9]{1}[0-9]*																											
enumeration	1	documentation <![CDATA[Periodo di imposta che inizia dalla data di messa in liquidazione per cessazione di attività, per fallimento o per liquidazione coatta amministrativa]]>																										
enumeration	2	documentation <![CDATA[Periodi di imposta successivi a quello di dichiarazione di fallimento o di messa in liquidazione]]>																										
enumeration	3	documentation <![CDATA[Periodo d'imposta in cui ha avuto termine la liquidazione per cessazione di attività, per fallimento o per liquidazione coatta amministrativa]]>																										
enumeration	4	documentation <![CDATA[Periodo di imposta in cui si è verificata l'estinzione del soggetto per fusione o incorporazione]]>																										
enumeration	5	documentation <![CDATA[Periodo d'imposta in cui è avvenuta la trasformazione da società soggetta ad IRES in società non soggetta ad IRES o viceversa]]>																										
enumeration	6	documentation <![CDATA[Periodo normale d'imposta e periodo compreso tra l'inizio del periodo d'imposta e la data di messa in liquidazione]]>																										
enumeration	7	documentation <![CDATA[Periodo d'imposta in cui si è verificata l'estinzione del soggetto per scissione totale]]>																										
source	<pre> <xs:simpleType name="Situazione_Type"> <xs:restriction base="cm:DatoNP_Type"> <xs:enumeration value="1"> <xs:annotation> <xs:documentation><![CDATA[Periodo di imposta che inizia dalla data di messa in liquidazione per cessazione di attività, per fallimento o per liquidazione coatta amministrativa]]></xs:documentation> </xs:annotation> </xs:enumeration> <xs:enumeration value="2"> <xs:annotation> <xs:documentation><![CDATA[Periodi di imposta </pre>																											

```

successivi a quello di dichiarazione di fallimento o di messa
in liquidazione]]></xs:documentation>
  </xs:annotation>
</xs:enumeration>
<xs:enumeration value="3">
  <xs:annotation>
    <xs:documentation><![CDATA[Periodo d'imposta in cui
ha avuto termine la liquidazione per cessazione di attività,
per fallimento o per liquidazione coatta
amministrativa]]></xs:documentation>
  </xs:annotation>
</xs:enumeration>
<xs:enumeration value="4">
  <xs:annotation>
    <xs:documentation><![CDATA[Periodo di imposta in cui
si è verificata l'estinzione del soggetto per fusione o
incorporazione]]></xs:documentation>
  </xs:annotation>
</xs:enumeration>
<xs:enumeration value="5">
  <xs:annotation>
    <xs:documentation><![CDATA[Periodo d'imposta in cui
è avvenuta la trasformazione da società soggetta ad IRES in
società non soggetta ad IRES o
viceversa]]></xs:documentation>
  </xs:annotation>
</xs:enumeration>
<xs:enumeration value="6">
  <xs:annotation>
    <xs:documentation><![CDATA[Periodo normale d'imposta
e periodo compreso tra l'inizio del periodo d'imposta e la
data di messa in liquidazione]]></xs:documentation>
  </xs:annotation>
</xs:enumeration>
<xs:enumeration value="7">
  <xs:annotation>
    <xs:documentation><![CDATA[Periodo d'imposta in cui
si è verificata l'estinzione del soggetto per scissione
totale]]></xs:documentation>
  </xs:annotation>
</xs:enumeration>
</xs:restriction>
</xs:simpleType>

```

simpleType **Stato_Type**

namespace	urn:www.agenziaentrate.gov.it:specificheTecniche:sco:common:v2
-----------	--

type	restriction of DatoNP_Type																		
properties	base cm:DatoNP_Type																		
used by	element Soggetti Diversi Da PF Type/Stato																		
facets	<table border="1"> <thead> <tr> <th>Kind</th> <th>Value</th> <th>annotation</th> </tr> </thead> <tbody> <tr> <td>pattern</td> <td>[1-9]{1}[0-9]*</td> <td></td> </tr> <tr> <td>enumeration</td> <td>1</td> <td>documentation <![CDATA[Soggetto in normale attività]]></td> </tr> <tr> <td>enumeration</td> <td>2</td> <td>documentation <![CDATA[Soggetto in liquidazione per cessazione di attività]]></td> </tr> <tr> <td>enumeration</td> <td>3</td> <td>documentation <![CDATA[Soggetto in fallimento o in liquidazione coatta amministrativa]]></td> </tr> <tr> <td>enumeration</td> <td>4</td> <td>documentation <![CDATA[Soggetto estinto]]></td> </tr> </tbody> </table>	Kind	Value	annotation	pattern	[1-9]{1}[0-9]*		enumeration	1	documentation <![CDATA[Soggetto in normale attività]]>	enumeration	2	documentation <![CDATA[Soggetto in liquidazione per cessazione di attività]]>	enumeration	3	documentation <![CDATA[Soggetto in fallimento o in liquidazione coatta amministrativa]]>	enumeration	4	documentation <![CDATA[Soggetto estinto]]>
Kind	Value	annotation																	
pattern	[1-9]{1}[0-9]*																		
enumeration	1	documentation <![CDATA[Soggetto in normale attività]]>																	
enumeration	2	documentation <![CDATA[Soggetto in liquidazione per cessazione di attività]]>																	
enumeration	3	documentation <![CDATA[Soggetto in fallimento o in liquidazione coatta amministrativa]]>																	
enumeration	4	documentation <![CDATA[Soggetto estinto]]>																	
source	<pre> <xs:simpleType name="Stato_Type"> <xs:restriction base="cm:DatoNP_Type"> <xs:enumeration value="1"> <xs:annotation> <xs:documentation><![CDATA[Soggetto in normale attività]]></xs:documentation> </xs:annotation> </xs:enumeration> <xs:enumeration value="2"> <xs:annotation> <xs:documentation><![CDATA[Soggetto in liquidazione per cessazione di attività]]></xs:documentation> </xs:annotation> </xs:enumeration> <xs:enumeration value="3"> <xs:annotation> <xs:documentation><![CDATA[Soggetto in fallimento o in liquidazione coatta amministrativa]]></xs:documentation> </xs:annotation> </xs:enumeration> <xs:enumeration value="4"> <xs:annotation> <xs:documentation><![CDATA[Soggetto estinto]]></xs:documentation> </xs:annotation> </xs:enumeration> </xs:restriction> </xs:simpleType> </pre>																		

simpleType **Eventi_Ecc_Type**

namespace	urn:www.agenziaentrate.gov.it:specificheTecniche:sco:common:v2						
type	restriction of xs:string						
properties	base xs:string						
facets	<table border="1"> <thead> <tr> <th>Kind</th> <th>Value</th> <th>annotation</th> </tr> </thead> <tbody> <tr> <td>enumeration</td> <td>1</td> <td>documentation</td> </tr> </tbody> </table>	Kind	Value	annotation	enumeration	1	documentation
Kind	Value	annotation					
enumeration	1	documentation					

	<p>enumeration 2 <![CDATA[Richieste estorsive]]> documentation</p> <p>enumeration 3 <![CDATA[Alluvione verificatasi nei giorni dal 31 ottobre al 2 novembre 2010 nel territorio della regione Veneto]]> documentation</p> <p>enumeration 4 <![CDATA[Soggetti con domicilio fiscale o sede operativa nel comune di Lampedusa e Linosa]]> documentation</p> <p>enumeration 5 <![CDATA[Altri eventi eccezionali]]> documentation</p> <p>enumeration 6 <![CDATA[Soggetti colpiti dalle eccezionali avversità atmosferiche verificatesi nel mese di ottobre 2011 nel territorio delle province di La Spezia e Massa Carrara]]> documentation</p> <p><![CDATA[Soggetti colpiti dalle eccezionali avversità atmosferiche verificatesi nei giorni dal 4 all'8 novembre 2011 nel territorio della provincia di Genova]]></p>
source	<pre> <xs:simpleType name="Eventi_Ecc_Type"> <xs:restriction base="xs:string"> <xs:enumeration value="1"> <xs:annotation> <xs:documentation><![CDATA[Richieste estorsive]]></xs:documentation> </xs:annotation> </xs:enumeration> <xs:enumeration value="2"> <xs:annotation> <xs:documentation><![CDATA[Alluvione verificatasi nei giorni dal 31 ottobre al 2 novembre 2010 nel territorio della regione Veneto]]></xs:documentation> </xs:annotation> </xs:enumeration> <xs:enumeration value="3"> <xs:annotation> <xs:documentation><![CDATA[Soggetti con domicilio fiscale o sede operativa nel comune di Lampedusa e Linosa]]></xs:documentation> </xs:annotation> </xs:enumeration> <xs:enumeration value="4"> <xs:annotation> <xs:documentation><![CDATA[Altri eventi eccezionali]]></xs:documentation> </xs:annotation> </xs:enumeration> <xs:enumeration value="5"> <xs:annotation> <xs:documentation><![CDATA[Soggetti colpiti dalle eccezionali avversità atmosferiche verificatesi nel mese di ottobre 2011 nel territorio delle province di La Spezia e Massa Carrara]]></xs:documentation> </xs:annotation> </xs:enumeration> <xs:enumeration value="6"> </pre>

	<pre> <xs:annotation> <xs:documentation><![CDATA[Soggetti colpiti dalle eccezionali avversità atmosferiche verificatesi nei giorni dal 4 all'8 novembre 2011 nel territorio della provincia di Genova]]></xs:documentation> </xs:annotation> </xs:enumeration> </xs:restriction> </xs:simpleType> </pre>
--	--

simpleType Estero

namespace	urn:www.agenziaentrate.gov.it:specificheTecniche:common:v2
type	restriction of xs:string
properties	base xs:string
used by	simpleTypes PE_Type PN_Type
facets	Kind Value annotation enumeration EE
source	<pre> <xs:simpleType name="Estero"> <xs:restriction base="xs:string"> <xs:enumeration value="EE"/> </xs:restriction> </xs:simpleType> </pre>

simpleType PE_Type

namespace	urn:www.agenziaentrate.gov.it:specificheTecniche:common:v2
type	union of (ProvincieItaliane , Estero)
used by	element Domicilio EE_Type/Provincia
annotation	documentation Tipo semplice costituito dalle sigle delle provincie italiane in vigore e dalla sigla "EE" che indica un paese estero.
source	<pre> <xs:simpleType name="PE_Type"> <xs:annotation> <xs:documentation>Tipo semplice costituito dalle sigle delle provincie italiane in vigore e dalla sigla "EE" che indica un paese estero.</xs:documentation> </xs:annotation> <xs:union memberTypes="ProvincieItaliane Estero"/> </xs:simpleType> </pre>

simpleType PN_Type

namespace	urn:www.agenziaentrate.gov.it:specificheTecniche:common:v2
type	union of (ProvincieItaliane , ProvincieCroate , Estero)

used by	elements Dati_Nascita_PF_Type/ProvinciaNascita Dati_Anagrafici_Type/ProvinciaNascita DatiAnagraficiScelte_Type/ProvinciaNascita
annotation	documentation Tipo semplice costituito dalle sigle delle provincie italiane in vigore, dalle sigle delle provincie croate di Fiume, Pola e Zara e dalla sigla "EE" che indica un paese estero.
source	<pre><xs:simpleType name="PN_Type"> <xs:annotation> <xs:documentation>Tipo semplice costituito dalle sigle delle provincie italiane in vigore, dalle sigle delle provincie croate di Fiume, Pola e Zara e dalla sigla "EE" che indica un paese estero.</xs:documentation> </xs:annotation> <xs:union memberTypes="ProvincieItaliane ProvincieCroate Estero"/> </xs:simpleType></pre>

simpleType PR_Type

namespace	urn:www.agenziaentrate.gov.it:specificheTecniche:common:v2
type	union of (ProvincieItaliane)
used by	elements Domicilio_Fiscale_type/Provincia Residenza_Type/Provincia Domicilio_Sogg_Ass_Fiscale_Type/Provincia Domicilio_Ita_Type/Provincia Fornitura/Intestazione/UfficioPerifericoCAF/Provincia
annotation	documentation Tipo semplice costituito dalle sigle delle provincie italiane in vigore.
source	<pre><xs:simpleType name="PR_Type"> <xs:annotation> <xs:documentation>Tipo semplice costituito dalle sigle delle provincie italiane in vigore.</xs:documentation> </xs:annotation> <xs:union memberTypes="ProvincieItaliane"/> </xs:simpleType></pre>

simpleType ProvincieCroate

namespace	urn:www.agenziaentrate.gov.it:specificheTecniche:common:v2												
type	restriction of xs:string												
properties	base xs:string												
used by	simpleType PN_Type												
facets	<table border="1"> <thead> <tr> <th>Kind</th> <th>Value</th> <th>annotation</th> </tr> </thead> <tbody> <tr> <td>enumeration</td> <td>FU</td> <td>documentation Fiume</td> </tr> <tr> <td>enumeration</td> <td>PL</td> <td>documentation Pola</td> </tr> <tr> <td>enumeration</td> <td>ZA</td> <td>documentation Zara</td> </tr> </tbody> </table>	Kind	Value	annotation	enumeration	FU	documentation Fiume	enumeration	PL	documentation Pola	enumeration	ZA	documentation Zara
Kind	Value	annotation											
enumeration	FU	documentation Fiume											
enumeration	PL	documentation Pola											
enumeration	ZA	documentation Zara											
source	<pre><xs:simpleType name="ProvincieCroate"> <xs:restriction base="xs:string"> <xs:enumeration value="FU"> <xs:annotation></pre>												

```

        <xs:documentation>Fiume</xs:documentation>
    </xs:annotation>
</xs:enumeration>
<xs:enumeration value="PL">
    <xs:annotation>
        <xs:documentation>Pola</xs:documentation>
    </xs:annotation>
</xs:enumeration>
<xs:enumeration value="ZA">
    <xs:annotation>
        <xs:documentation>Zara</xs:documentation>
    </xs:annotation>
</xs:enumeration>
</xs:restriction>
</xs:simpleType>

```

simpleType **ProvinciItaliane**

namespace	urn:www.agenziaentrate.gov.it:specificheTecniche:common:v2		
type	restriction of xs:string		
properties	base xs:string		
used by	simpleTypes PE_Type PN_Type PR_Type		
facets	Kind	Value annotation	
	enumeration	AG	
	enumeration	AL	
	enumeration	AN	
	enumeration	AO	
	enumeration	AP	
	enumeration	AQ	
	enumeration	AR	
	enumeration	AT	
	enumeration	AV	
	enumeration	BA	
	enumeration	BG	
	enumeration	BI	
	enumeration	BL	
	enumeration	BN	
	enumeration	BO	
	enumeration	BR	
	enumeration	BS	
	enumeration	BT	
	enumeration	BZ	
	enumeration	CA	
	enumeration	CB	
	enumeration	CE	
	enumeration	CH	

enumeration	CI
enumeration	CL
enumeration	CN
enumeration	CO
enumeration	CR
enumeration	CS
enumeration	CT
enumeration	CZ
enumeration	EN
enumeration	FC
enumeration	FE
enumeration	FG
enumeration	FI
enumeration	FM
enumeration	FR
enumeration	GE
enumeration	GO
enumeration	GR
enumeration	IM
enumeration	IS
enumeration	KR
enumeration	LC
enumeration	LE
enumeration	LI
enumeration	LO
enumeration	LT
enumeration	LU
enumeration	MB
enumeration	MC
enumeration	ME
enumeration	MI
enumeration	MN
enumeration	MO
enumeration	MS
enumeration	MT
enumeration	NA
enumeration	NO
enumeration	NU
enumeration	OG
enumeration	OR
enumeration	OT
enumeration	PA
enumeration	PC
enumeration	PD
enumeration	PE
enumeration	PG
enumeration	PI

	enumeration PN enumeration PO enumeration PR enumeration PT enumeration PU enumeration PV enumeration PZ enumeration RA enumeration RC enumeration RE enumeration RG enumeration RI enumeration RM enumeration RN enumeration RO enumeration SA enumeration SI enumeration SO enumeration SP enumeration SR enumeration SS enumeration SV enumeration TA enumeration TE enumeration TN enumeration TO enumeration TP enumeration TR enumeration TS enumeration TV enumeration UD enumeration VA enumeration VB enumeration VC enumeration VE enumeration VI enumeration VR enumeration VS enumeration VT enumeration VV																					
annotation	documentation <p style="text-align: center;">Elenco delle provincie italiane in vigore, valori ammessi:</p> <table style="margin-left: auto; margin-right: auto;"> <tr> <td>Agrigento</td> <td>AG</td> <td></td> </tr> <tr> <td>Alessandria</td> <td></td> <td>AL</td> </tr> <tr> <td>Ancona</td> <td></td> <td>AN</td> </tr> <tr> <td>Aosta</td> <td>AO</td> <td></td> </tr> <tr> <td>Ascoli Piceno</td> <td>AP</td> <td></td> </tr> <tr> <td>L'Aquila</td> <td>AQ</td> <td></td> </tr> <tr> <td>Arezzo</td> <td></td> <td>AR</td> </tr> </table>	Agrigento	AG		Alessandria		AL	Ancona		AN	Aosta	AO		Ascoli Piceno	AP		L'Aquila	AQ		Arezzo		AR
Agrigento	AG																					
Alessandria		AL																				
Ancona		AN																				
Aosta	AO																					
Ascoli Piceno	AP																					
L'Aquila	AQ																					
Arezzo		AR																				

	Asti		AT
	Avellino	AV	
	Bari		BA
	Bergamo		BG
	Biella		BI
	Belluno		BL
	Benevento		BN
	Bologna		BO
	Brindisi	BR	
	Brescia		BS
	Barletta-Andria-Trani	BT	
	Bolzano		BZ
	Cagliari	CA	
	Campobasso		CB
	Caserta		CE
	Chieti		CH
	Carbonia-Iglesias	CI	
	Caltanissetta	CL	
	Cuneo		CN
	Como		CO
	Cremona		CR
	Cosenza		CS
	Catania		CT
	Catanzaro		CZ
	Enna		EN
	Forli-Cesena	FC	
	Ferrara		FE
	Foggia		FG
	Firenze		FI
	Fermo		FM
	Frosinone	FR	
	Genova		GE
	Gorizia		GO
	Grosseto	GR	
	Imperia		IM
	Isernia		IS
	Crotone		KR
	Lecco		LC
	Lecce		LE
	Livorno		LI
	Lodi		LO
	Latina		LT
	Lucca		LU
	Monza e Brianza	MB	
	Macerata	MC	
	Messina		ME
	Milano		MI
	Mantova		MN
	Modena		MO
	Massa e Carrara	MS	
	Matera		MT
	Napoli		NA
	Novara		NO
	Nuoro		NU
	Ogliastra	OG	
	Oristano	OR	
	Olbia-Tempio	OT	
	Palermo		PA
	Piacenza	PC	
	Padova		PD
	Pescara		PE
	Perugia		PG
	Pisa		PI
	Pordenone		PN
	Prato		PO
	Parma		PR
	Pistoia		PT
	Pesaro e Urbino	PU	
	Pavia		PV
	Potenza		PZ

		Ravenna		RA
		Reggio Calabria	RC	
		Reggio Emilia	RE	
		Ragusa		RG
		Rieti		RI
		Roma		RM
		Rimini		RN
		Rovigo		RO
		Salerno		SA
		iena		SI
		Sondrio		SO
		La Spezia	SP	
		Siracusa	SR	
		Sassari		SS
		Savona		SV
		Taranto		TA
		Teramo		TE
		Trento		TN
		Torino		TO
		Trapani		TP
		Terni		TR
		Trieste		TS
		Treviso		TV
		Udine		UD
		Varese		VA
		Verbano-Cusio-Ossola	VB	
		Vercelli	VC	
		Venezia		VE
		Vicenza		VI
		Verona		VR
		Medio Campidano	VS	
		Viterbo		VT
		Vibo Valentia	VV	

source	<pre> <xs:simpleType name="ProvinceItaliane"> <xs:annotation> <xs:documentation> Elenco delle provincie italiane in vigore, valori ammessi: Agrigento AG Alessandria AL Ancona AN Aosta AO Ascoli Piceno AP L'Aquila AQ Arezzo AR Asti AT Avellino AV Bari BA Bergamo BG Biella BI Belluno BL Benevento BN Bologna BO Brindisi BR Brescia BS </pre>
--------	--

	Barletta-Andria-Trani	BT	
	Bolzano		BZ
	Cagliari	CA	
	Campobasso		CB
	Caserta		CE
	Chieti		CH
	Carbonia-Iglesias	CI	
	Caltanissetta	CL	
	Cuneo		CN
	Como	CO	
	Cremona		CR
	Cosenza		CS
	Catania		CT
	Catanzaro	CZ	
	Enna	EN	
	Forlì-Cesena	FC	
	Ferrara		FE
	Foggia		FG
	Firenze		FI
	Fermo		FM
	Frosinone	FR	
	Genova		GE
	Gorizia		GO
	Grosseto	GR	
	Imperia		IM
	Isernia		IS
	Crotone		KR
	Lecco		LC
	Lecce		LE
	Livorno		LI
	Lodi	LO	
	Latina		LT
	Lucca		LU
	Monza e Brianza		MB
	Macerata	MC	
	Messina		ME
	Milano		MI
	Mantova		MN
	Modena		MO
	Massa e Carrara		MS
	Matera		MT
	Napoli		NA
	Novara		NO
	Nuoro		NU
	Ogliastra	OG	
	Oristano	OR	
	Olbia-Tempio	OT	

	Palermo		PA
	Piacenza	PC	
	Padova		PD
	Pescara		PE
	Perugia		PG
	Pisa	PI	
	Pordenone	PN	
	Prato		PO
	Parma		PR
	Pistoia		PT
	Pesaro e Urbino		PU
	Pavia		PV
	Potenza		PZ
	Ravenna		RA
	Reggio Calabria		RC
	Reggio Emilia	RE	
	Ragusa		RG
	Rieti		RI
	Roma	RM	
	Rimini		RN
	Rovigo		RO
	Salerno		SA
	iena	SI	
	Sondrio		SO
	La Spezia	SP	
	Siracusa	SR	
	Sassari		SS
	Savona		SV
	Taranto		TA
	Teramo		TE
	Trento		TN
	Torino		TO
	Trapani		TP
	Terni		TR
	Trieste		TS
	Treviso		TV
	Udine		UD
	Varese		VA
	Verbano-Cusio-Ossola	VB	
	Vercelli	VC	
	Venezia		VE
	Vicenza		VI
	Verona		VR
	Medio Campidano		VS
	Viterbo		VT
	Vibo Valentia	VV	

```
                </xs:documentation>
</xs:annotation>
<xs:restriction base="xs:string">
  <xs:enumeration value="AG" />
  <xs:enumeration value="AL" />
  <xs:enumeration value="AN" />
  <xs:enumeration value="AO" />
  <xs:enumeration value="AP" />
  <xs:enumeration value="AQ" />
  <xs:enumeration value="AR" />
  <xs:enumeration value="AT" />
  <xs:enumeration value="AV" />
  <xs:enumeration value="BA" />
  <xs:enumeration value="BG" />
  <xs:enumeration value="BI" />
  <xs:enumeration value="BL" />
  <xs:enumeration value="BN" />
  <xs:enumeration value="BO" />
  <xs:enumeration value="BR" />
  <xs:enumeration value="BS" />
  <xs:enumeration value="BT" />
  <xs:enumeration value="BZ" />
  <xs:enumeration value="CA" />
  <xs:enumeration value="CB" />
  <xs:enumeration value="CE" />
  <xs:enumeration value="CH" />
  <xs:enumeration value="CI" />
  <xs:enumeration value="CL" />
  <xs:enumeration value="CN" />
  <xs:enumeration value="CO" />
  <xs:enumeration value="CR" />
  <xs:enumeration value="CS" />
  <xs:enumeration value="CT" />
  <xs:enumeration value="CZ" />
  <xs:enumeration value="EN" />
  <xs:enumeration value="FC" />
  <xs:enumeration value="FE" />
  <xs:enumeration value="FG" />
  <xs:enumeration value="FI" />
  <xs:enumeration value="FM" />
  <xs:enumeration value="FR" />
  <xs:enumeration value="GE" />
  <xs:enumeration value="GO" />
  <xs:enumeration value="GR" />
  <xs:enumeration value="IM" />
  <xs:enumeration value="IS" />
  <xs:enumeration value="KR" />
```

```
<xs:enumeration value="LC"/>
<xs:enumeration value="LE"/>
<xs:enumeration value="LI"/>
<xs:enumeration value="LO"/>
<xs:enumeration value="LT"/>
<xs:enumeration value="LU"/>
<xs:enumeration value="MB"/>
<xs:enumeration value="MC"/>
<xs:enumeration value="ME"/>
<xs:enumeration value="MI"/>
<xs:enumeration value="MN"/>
<xs:enumeration value="MO"/>
<xs:enumeration value="MS"/>
<xs:enumeration value="MT"/>
<xs:enumeration value="NA"/>
<xs:enumeration value="NO"/>
<xs:enumeration value="NU"/>
<xs:enumeration value="OG"/>
<xs:enumeration value="OR"/>
<xs:enumeration value="OT"/>
<xs:enumeration value="PA"/>
<xs:enumeration value="PC"/>
<xs:enumeration value="PD"/>
<xs:enumeration value="PE"/>
<xs:enumeration value="PG"/>
<xs:enumeration value="PI"/>
<xs:enumeration value="PN"/>
<xs:enumeration value="PO"/>
<xs:enumeration value="PR"/>
<xs:enumeration value="PT"/>
<xs:enumeration value="PU"/>
<xs:enumeration value="PV"/>
<xs:enumeration value="PZ"/>
<xs:enumeration value="RA"/>
<xs:enumeration value="RC"/>
<xs:enumeration value="RE"/>
<xs:enumeration value="RG"/>
<xs:enumeration value="RI"/>
<xs:enumeration value="RM"/>
<xs:enumeration value="RN"/>
<xs:enumeration value="RO"/>
<xs:enumeration value="SA"/>
<xs:enumeration value="SI"/>
<xs:enumeration value="SO"/>
<xs:enumeration value="SP"/>
<xs:enumeration value="SR"/>
<xs:enumeration value="SS"/>
```

```
<xs:enumeration value="SV" />
<xs:enumeration value="TA" />
<xs:enumeration value="TE" />
<xs:enumeration value="TN" />
<xs:enumeration value="TO" />
<xs:enumeration value="TP" />
<xs:enumeration value="TR" />
<xs:enumeration value="TS" />
<xs:enumeration value="TV" />
<xs:enumeration value="UD" />
<xs:enumeration value="VA" />
<xs:enumeration value="VB" />
<xs:enumeration value="VC" />
<xs:enumeration value="VE" />
<xs:enumeration value="VI" />
<xs:enumeration value="VR" />
<xs:enumeration value="VS" />
<xs:enumeration value="VT" />
<xs:enumeration value="VV" />
</xs:restriction>
</xs:simpleType>
```

Schema forniture730-4_12_v1.xsd

schema location: [forniture730-4_12_v1.xsd](#)
 attribute form default: **unqualified**
 element form default: **qualified**
 targetNamespace: **urn:www.agenziaentrate.gov.it:specificheTecniche:sco:730:v1**

Elements

[Forniture730-4](#)

element Forniture730-4

diagram	<p>Comment describing your root element</p>
namespace	urn:www.agenziaentrate.gov.it:specificheTecniche:sco:730:v1
properties	content complex
children	m730:Intestazione m730:Documento730-4
annotation	documentation Comment describing your root element
source	<pre> <xs:element name="Forniture730-4"> <xs:annotation> <xs:documentation>Comment describing your root element</xs:documentation> </xs:annotation> <xs:complexType> <xs:sequence> <xs:element name="Intestazione"> <xs:complexType> <xs:complexContent> <xs:extension base="cm:Dati_Intestazione_Type"> <xs:sequence> <xs:element name="CodiceForniture" type="cm:CodiceForniture_Type" fixed="M7312"/> <xs:element name="TipoFornitore" type="cm:DatoNP_Type" fixed="13"/> <xs:element name="TotaleDocumenti" type="cm:DatoNP_Type" minOccurs="0"/> </xs:sequence> </xs:extension> </xs:complexContent> </xs:complexType> </xs:element> <xs:element name="Documento730-4" </pre>

	<pre> type="m730:Documento_730-4" maxOccurs="unbounded"/> </xs:sequence> </xs:complexType> </xs:element> </pre>
--	--

element Fornitura730-4/Intestazione

diagram	
namespace	urn:www.agenziaentrate.gov.it:specificheTecniche:sco:730:v1
type	extension of Dati_Intestazione_Type
properties	isRef 0 content complex
children	CodiceFiscaleFornitore SpazioUtente SpazioServizioTelematico m730:CodiceFornitura m730:TipoFornitore m730:TotaleDocumenti
source	<pre> <xs:element name="Intestazione"> <xs:complexType> <xs:complexContent> <xs:extension base="cm:Dati_Intestazione_Type"> <xs:sequence> <xs:element name="CodiceFornitura" type="cm:CodiceFornitura_Type" fixed="M7312"/> <xs:element name="TipoFornitore" type="cm:DatoNP_Type" fixed="13"/> <xs:element name="TotaleDocumenti" type="cm:DatoNP_Type" minOccurs="0"/> </xs:sequence> </xs:extension> </xs:complexContent> </xs:complexType> </xs:element> </pre>

element Fornitura730-4/Intestazione/CodiceFornitura

diagram	
namespace	urn:www.agenziaentrate.gov.it:specificheTecniche:sco:730:v1
type	CodiceFornitura_Type
properties	isRef 0 content simple fixed M7312
facets	Kind Value annotation length 5 pattern [0-9A-Z\-\]{1}([0-9A-Z] \- \. & _ \\s / ° ^\ ()\)*
source	<pre><xs:element name="CodiceFornitura" type="cm:CodiceFornitura_Type" fixed="M7312"/></pre>

element Fornitura730-4/Intestazione/TipoFornitore

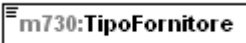
diagram	
namespace	urn:www.agenziaentrate.gov.it:specificheTecniche:sco:730:v1
type	DatoNP_Type
properties	isRef 0 content simple fixed 13
facets	Kind Value annotation pattern [1-9]{1}[0-9]*
source	<pre><xs:element name="TipoFornitore" type="cm:DatoNP_Type" fixed="13"/></pre>

element Fornitura730-4/Intestazione/TotaleDocumenti

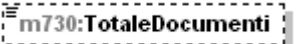
diagram	
namespace	urn:www.agenziaentrate.gov.it:specificheTecniche:sco:730:v1
type	DatoNP_Type
properties	isRef 0 minOcc 0 maxOcc 1 content simple
facets	Kind Value annotation pattern [1-9]{1}[0-9]*
source	<pre><xs:element name="TotaleDocumenti" type="cm:DatoNP_Type" minOccurs="0"/></pre>

element **Fornitura730-4/Documento730-4**

diagram	
namespace	urn:www.agenziaentrate.gov.it:specificheTecniche:sco:730:v1
type	m730:Documento_730-4
properties	isRef 0 minOcc 1 maxOcc unbounded content complex
children	m730:DatiAnagraficiDichiarante m730:Sostituto m730:SoggettoAssFiscale730-4 m730:AltriDati m730:DatiContabili730-4
source	<pre><xs:element name="Documento730-4" type="m730:Documento_730-4" maxOccurs="unbounded"/></pre>